

# MANUAL DE MONTAGEM / ASSEMBLY INSTRUCTIONS / PLANO DE ARMADO

**Antes de montar o móvel, leia com atenção o manual de montagem!**  
**Before assembling the furniture, carefully read the assembly instructions!**  
**Antes de armar el mueble, lea con atención el manual de ensamble!**

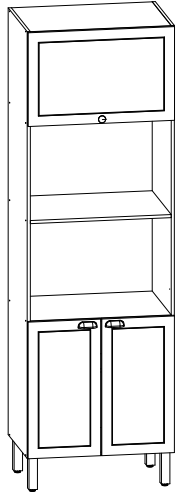

**Ref.: 1356**

**geniaflex**  
ambientes incríveis para todos

Parabéns! Você comprou um produto de excelente qualidade, fabricado com chapa de madeira de MDP ou MDF, extraída de florestas renováveis. Possui alta resistência e design atual.

Congratulations! You have purchased a product of excellent quality, made from MDP or MDF wood veneer, extracted from renewable forests. It has high strength and current design.

Felicitaciones! Usted compró a un producto de excelente calidad, fabricado con placa de madera de MDP o MDF, proveniente de florestas renovables. Tiene alta resistencia y diseño actual.



**ATENÇÃO**  
**ATENCIÓN**  
**ATENCIÓN**

**1)** Verifique todas as peças antes de começar a montagem.

Check all parts before starting assembly.

Verifique todas las partes antes de empezar el armado.

**2)** Ao começar a montagem, não apoie as peças na parede.

When starting the assembly, do not support the parts on the wall.

Al empezar el armado, no apoyes las partes en la pared.

**3)** Ao colocar as peças e ferragens de lado, cuidado para não perde-las.

When placing parts and hardware aside, be careful not to lose them.

Al poner las piezas y herrages a parte, cuidado para no dañarlas.

**4)** O móvel deve ser montado no chão, para isso, use a própria caixa para proteger e não danificar o piso.

The furniture must be mounted on the floor, to do this, use the box itself to protect and not damage the floor.

El mueble suele ser armando al piso, para eso, use la propia caja para protegerlo y no dañar al piso.

**5)** Comece a montagem seguindo as instruções passo a passo.

Begin assembly by following the step-by-step instructions.

Comience el armado siguiendo la instrucciones paso a paso.

**6)** É de responsabilidade do montador seguir as intruções desse manual, que são fundamentais para a estrutura do móvel.

It's the assembler's responsibility to follow the instructions in this manual, which are fundamental to the structure of the furniture.

Es de responsabilidad del armador seguir las instrucciones de este manual, que son fundamentales para la estructura del mueble.

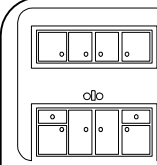

**CUIDADOS**  
**CARE**  
**CUIDADO**

**1)** A conservação e limpeza deve ser feita com um pano levemente umedecido com água.

Care and cleaning should be done with a cloth slightly moistened with water.

La conservación y limpieza debe ser hecha con un trapo levemente humedecido en agua.

**2)** Não use produtos abrasivos, como saponáceo, detergentes e esponja de aço.

Do not use abrasive products, such as soap, detergents and steel sponge.

No use productos abrasivos, como saponáceo, detergentes y esponja de acero.

**3)** Não use cera ou óleo para dar brilho ao móvel.

Do not use wax or oil to shine the furniture.

No use cera o aceites para darle brillo al mueble.

**4)** Não expor o móvel a interperies e nem ao calor excessivo.

Do not expose the furniture to weather or excessive heat.

No exponer el mueble a interperies ni al calor excesivo.

**5)** Ao terminar a montagem, limpe o ambiente e o móvel.

When the assembly is finished, clean the room and the furniture.

Al terminar el armado, limpie al ambiente y al mueble.

## FERRAMENTAS / TOOLS / HERRAMIENTAS



MARTELO  
HAMMER  
MARTILLO



NAO RECOMENDAVEL  
NOT ADVISABLE  
NO RECOMENDABLE



CHAVE PHILLIPS  
PHILLIPS SCREWDRIVER  
LLAVE PHILLIPS











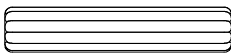

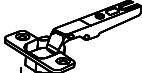

MARTELO DE BORRACHA  
RUBBER HAMMER  
MARTILLO GOMA

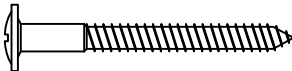

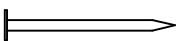
TRENA  
MEASURING TAP  
CINTA MÉTRICA

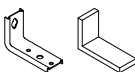
## FERRAGENS / HARDWARE / HERRAJES

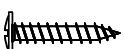
CÓD CODE COD	DESCRIÇÃO DESCRIPTION DESCRIPCIÓN	QTD QTY CANT
A	 CAVILHA WOODEN DOWEL TARUGO	20
B	 SUPORTE DE PRATELEIRA SHELF SUPPORT SOPORTE DE ESTANTES	4
C	 PARAFUSO 4X14mm SCREW 4X14mm TORNILLO 4X14mm	33
D	 DOBRADIÇA HINGE BIZAGRA	6
E	 CALÇO PARA DOBRADIÇA HINGE SHED CALZO DE BISAGRA	6
F	 PUXADOR PULLER TIRADOR	3
G	 PÉ LEG PATA	4
H	 PARAFUSO 5X50mm SCREW 5X50mm TORNILLO 5X50mm	5
I	 PARAFUSO 3,5X40mm SCREW 3,5X40mm TORNILLO 3,5X40mm	20
J	 PREGO NAIL CLAVO	60
K	 PERFIL I PROFILE I PERFIL I	1
L	 PARAFUSO 3,5X25mm SCREW 3.5X25mm TORNILLO 3.5X25mm	5
M	 SUPORTE DE FIXAÇÃO MOUNTING SUPPORT SOPORTE DE MONTAJE	1
N	 BUCHA PLÁSTICA PLASTIC BUSHING CASQUILLO PLÁSTICO	1
O	 PISTÃO PISTON PISTÓN	1
P	 PARAFUSO 3.5X25mm SCREW 3.5X25mm TORNILLO 3.5X25mm	6

UTILIZE A RÉGUA PARA IDENTIFICAR OS PARAFUSOS  
USE THE RULER TO IDENTIFY THE SCREWS  
UTILICE LA REGLA PARA IDENTIFICAR LOS TORNILLOS

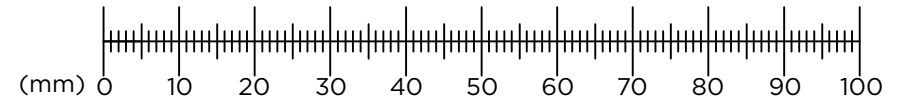

**PESO SUPORTADO / WEIGHT SUPPORTED / PESO SOPORTADO**

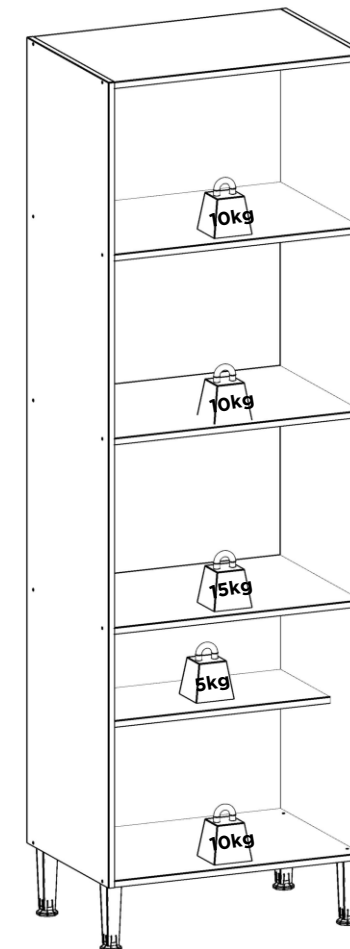

**PEÇAS / PARTS / PIEZAS**

Nº No Num	DESCRIÇÃO DESCRIPTION DESCRIPCIÓN	QTD QTY CANT
1	LATERAL DIREITA RIGHT SIDE PANEL LATERAL DERECHA	1
2	LATERAL ESQUERDA LEFT SIDE PANEL LATERAL IZQUIERDA	1
3	BASE BOTTOM BASE	1
4	TAMPO TOP TABLERO	1
5	COSTA INFERIOR LOWER BACK PANEL TRASERO INFERIOR	2
7	PRATELEIRA PLATE PANEL REPISA	1
8	PORTA DOOR PUERTA	2
9	PORTA BASCULANTE TILTING DOOR PUERTA BASCULANTE	1
12	BASE / PRATELEIRA BOTTOM PANEL / PLATE PANEL BASE / REPISA	3
13	COSTA SUPERIOR UPPER BACK PANEL TRASERO SUPERIOR	1

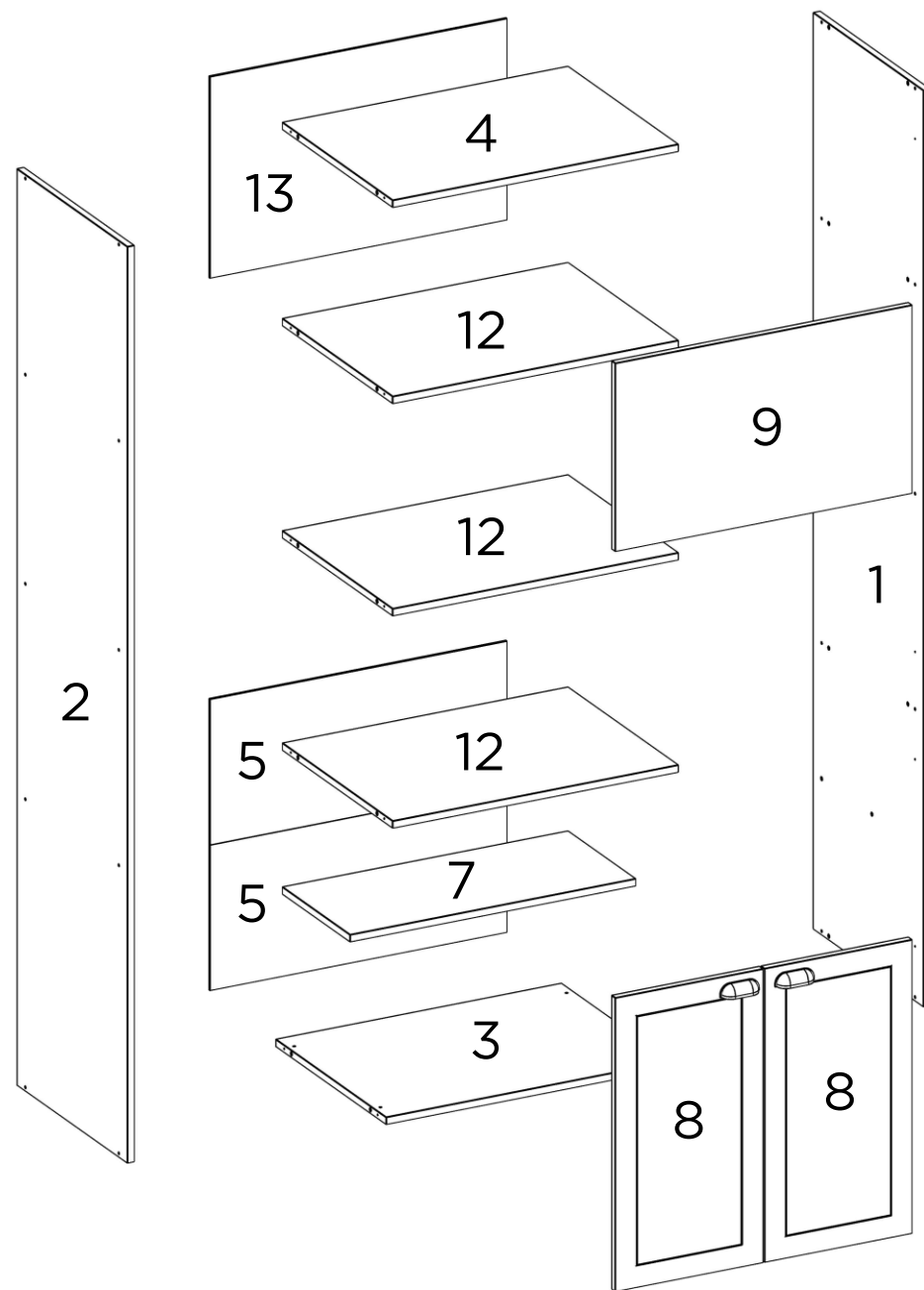



7

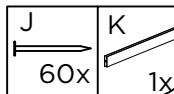
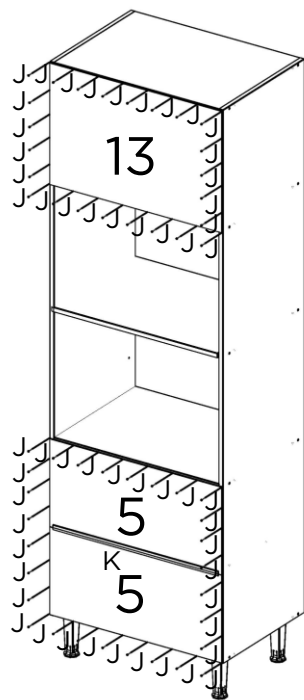

8

**UNIÃO DE MÓDULOS**  
JOINING MODULES  
UNIÓN DE MÓDULOS

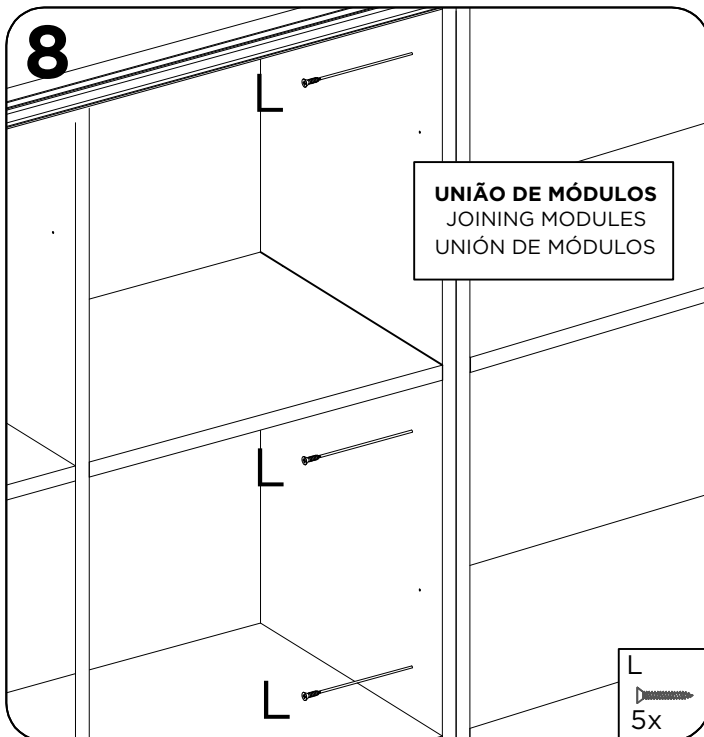

9

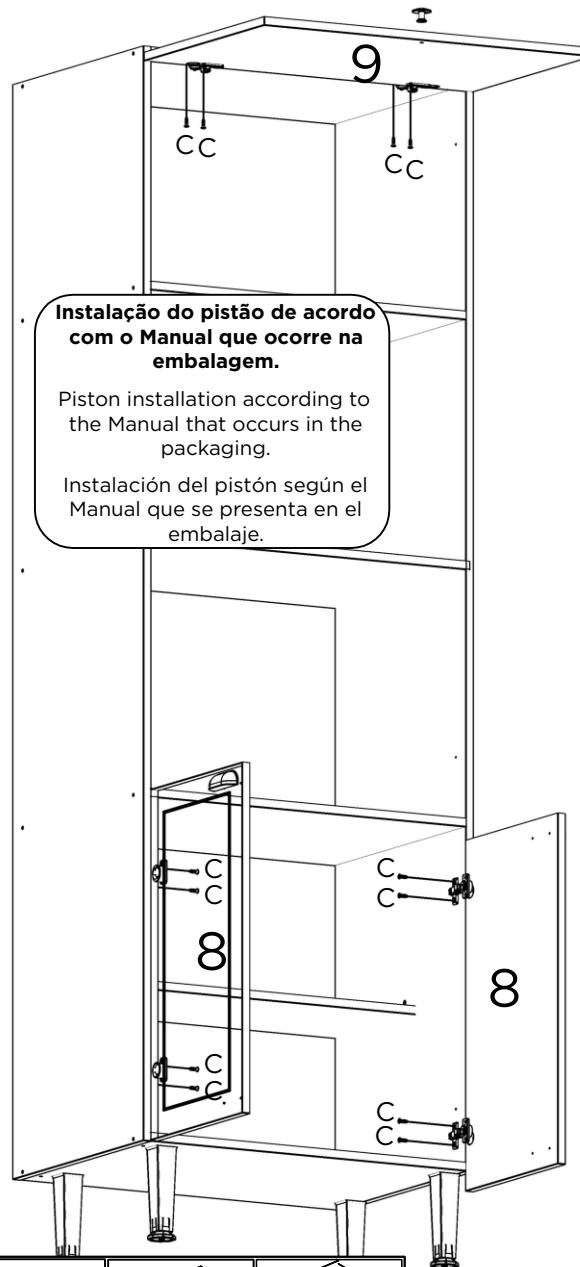

**Instalação do pistão de acordo com o Manual que ocorre na embalagem.**

Piston installation according to the Manual that occurs in the packaging.

Instalación del pistón según el Manual que se presenta en el embalaje.

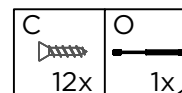
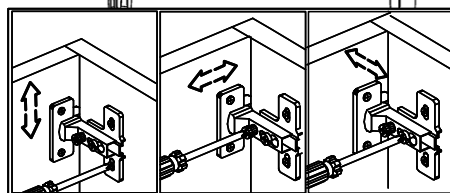

10

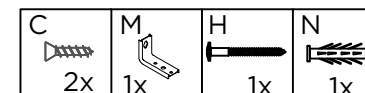
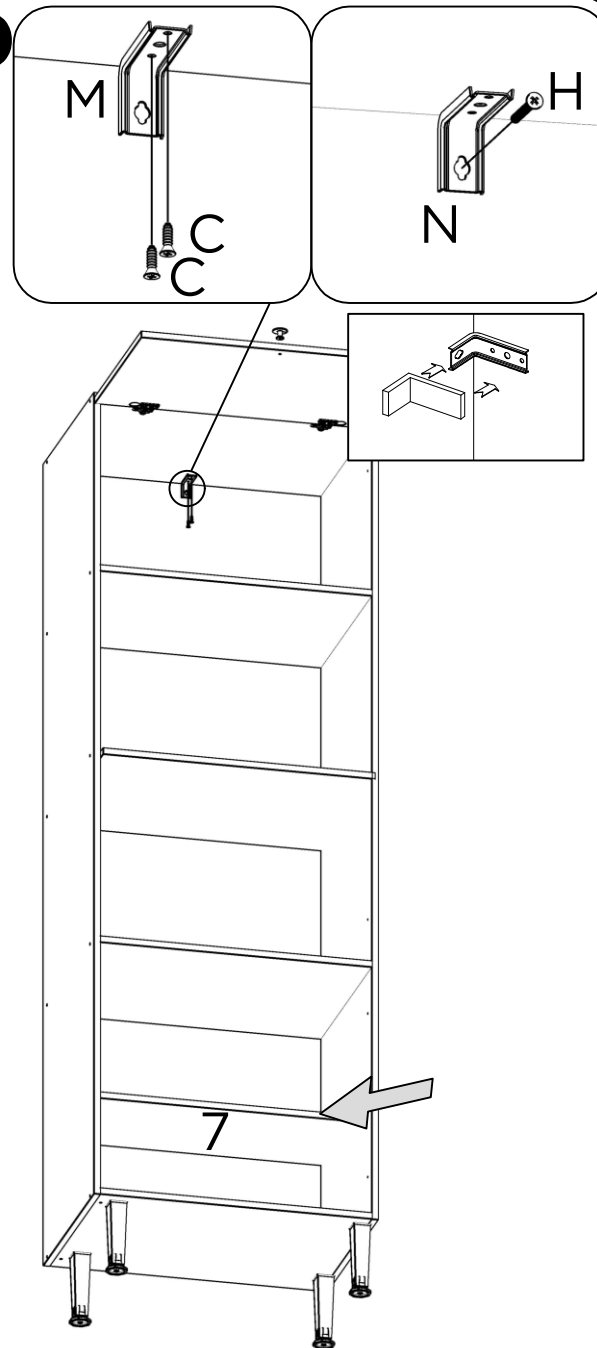

**P**

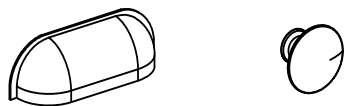

Parafuso 3,5x25mm

