



mxmóveis

Rodovia SC-492 - Km 10 - B. Industrial

89905-000 - Bandeirante - SC

Fone: (49) 3622-4549

e-mail: mxmoveis@mxmoveis.com.br

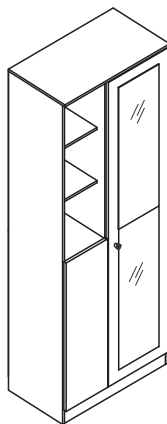

Ref. MU001

Sapateira
Mueble para zapato
Furniture for shoes

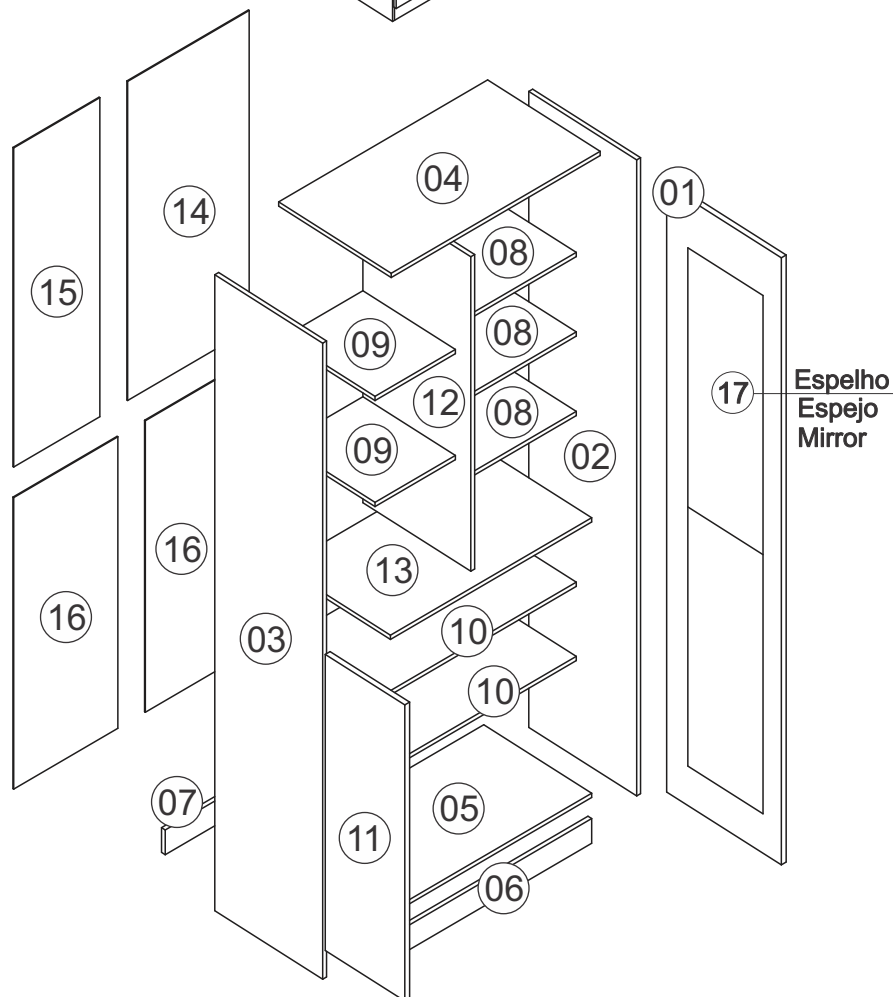

Nº	CÓDIGO CODE ASSISTÊNCIA ATTENDANCE	NOME DA PEÇA/DESCRIPCIÓN PIEZAS/DESCRIPTION PARTS	MEDIDAS (mm) MEASURES (mm)	QTD.	CÓDIGO DAS PEÇAS/CÓDIGO PIEZAS				
					HAVANA/ HAVANA RIP.	TERRANO/ TERRANO RIP.	MARROCOS	BRANCO	NOGAL
01	MU001.25.00	Porta/Puerta/Door	1722x373x15	01	54306	54295	189468	54229	154093
02	MU001.17.00	Lateral externa direita/Lateral derecha/Right side	1800x350x12	01	152383	54638	189469	54501	154094
03	MU001.18.00	Lateral externa esquerda/Lateral izquierda/Left side	1800x350x12	01	152384	58761	189470	58755	154095
04	MU001.05.00	Base superior/Base superior/Shelf	650x365x12	01	168824	168823	189472	168822	168828
05	MU001.01.00	Base Inferior/Base/Shelf	626x350x12	01	54511	54496	189473	54504	154098
06	MU001.30.02	Rodapé frontal/Zócalo delantero/Front footer	626x70x12	01	54312	49370	189474	54235	154099
07	MU001.32.00	Rodapé traseiro/Zócalo de atrás/Rear plinth	626x70x12	01	45477	45477	45477	45477	45477
08	MU001.27.02	Prateleira/Platelera/Silversmith	364x300x12	03	54497	54497	54497	54497	54497
09	MU001.27.01	Prateleira/Platelera/Silversmith	250x300x12	02	58763	58759	189475	58756	154100
10	MU001.27.00	Prateleira/Platelera/Silversmith	626x300x12	02	54498	54498	54498	54498	54498
11	MU001.25.01	Porta/Puerta/Door	840x260x15	01	54305	54294	189467	54228	154092
12	MU001.19.00	Lateral interna/Lateral interna/Inner side	890x350x12	01	54509	54494	189471	54502	154096
13	MU001.02.01	Base interna/Base interna/Interna base	626x350x12	01	58764	58760	189476	58757	154101
14	MU001.13.00	Forro/Revés/botton	903x378x2,5	01	51000	51000	51000	51000	51000
15	MU001.13.02	Forro/Revés/botton	903x268x2,5	01	60777	60763	189477	60743	154102
16	MU001.13.01	Forro/Revés/botton	830x323x2,5	02	51002	51002	51002	51002	51002
17	4861	Espelho/Espejo/ Mirror	800x250	02	-	-	-	-	-

Ferragens/Herrajes/Hardware

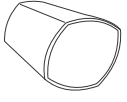
A  **01x**
Cód. 7759
Puxador/Manija/Puller

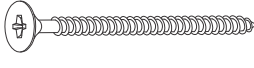
B  **20x**
Cód. 691
Parafuso/Tornillo/Screw 3.5x40mm Cht.

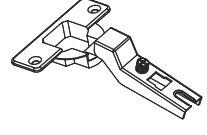
C  **05x**
Cód. 10269
Dobradiça/Visagra/Metal hinge

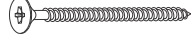
D  **01x**
Cód. 794
Parafuso/Tornillo/Screw 3.5x30mm Cht.

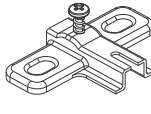
E  **05x**
Cód. 12539
Calço dobradiça/Calzo de visagra/ Chock to hinge

F  **65x**
Cód. 822
Prego/Clavo/Nail

G  **04x**
Cód. 873
Cavilha/Clavija/Peg Ø 6,0x30mm

H  **04x**
Cód. 800
Sapata/Zapata/Shoes

I  **28x**
Cód. 790
Suporte plastico/Soporte plastisco/ plastic support

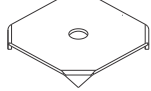
J  **09x**
Cód. 7169
Fixador costa/Fijador de orilla/ Shore Fixer

K  **01x**
Cód. 2059
Perfil plástico/plastic profile 825mm

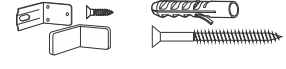
L  **01x**
Cód. 754
Kit aereo/Kit aerio/Air kit



M  **04x**
Cód. 821
Prego/Clavo/Nail

N  **20x**
Cód. 7604
Parafuso/Tornillo/Screw 4,0x12mm Cht.

O  **01x**
Cód. 8255
Bisnaga cola/tubo de pegamento/glue tube



Medidas em mm
Measures in mm
Mesuras en mm

	Produto para ser aplicado em caso de riscos na superfície.
	Product to be applied in case of scratches on the surface.
	Producto para ser aplicado en caso de rayas en la superficie.

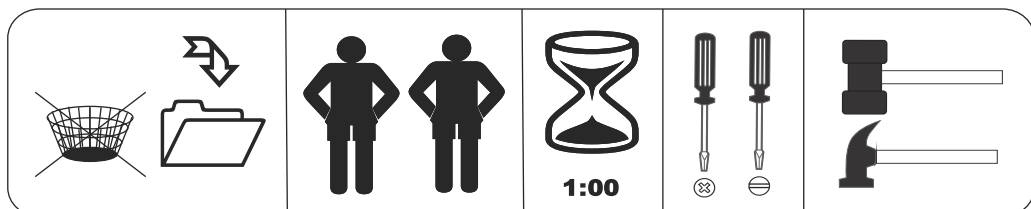

Pré-Montagem/Preparación Piezas/ Pre-assembly

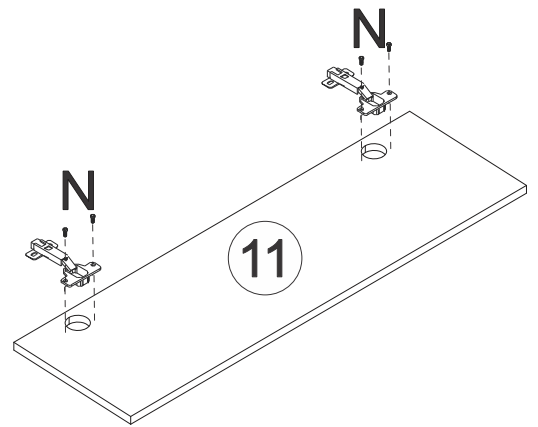
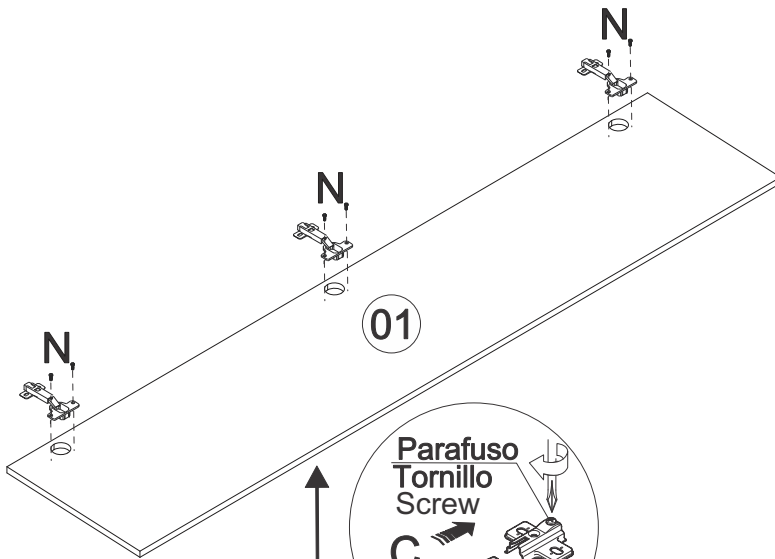

***Usar uma proteção**
no chão para não

danificar o espelho

***Utilizar una protección**
en el suelo para no

dañar el espejo

***Use a floor guard to avoid**
damaging the mirror.

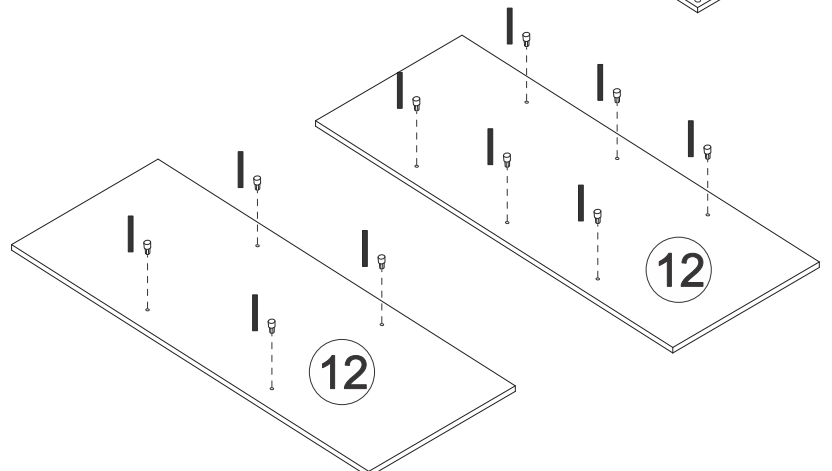
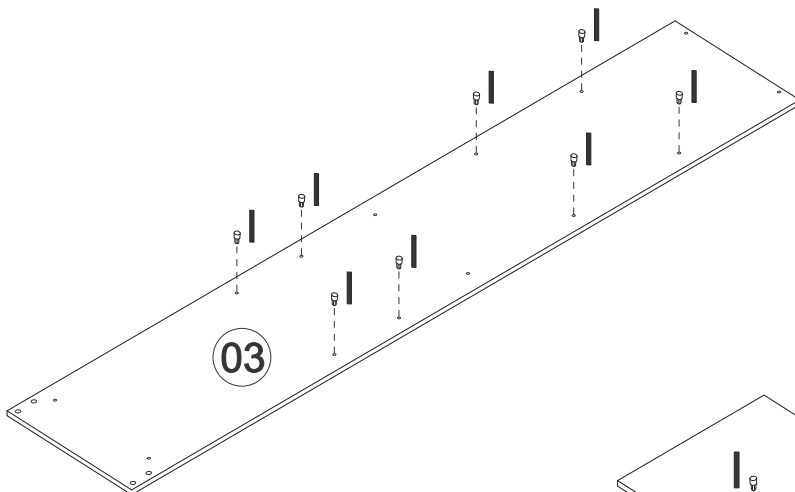
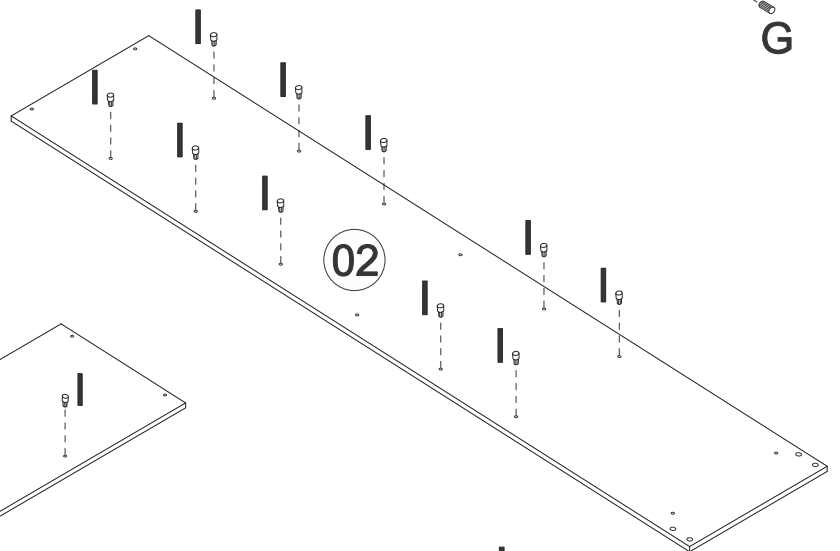
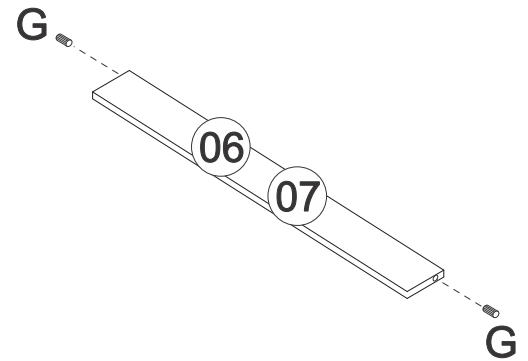

01 Montagem/Montaje/Assembly

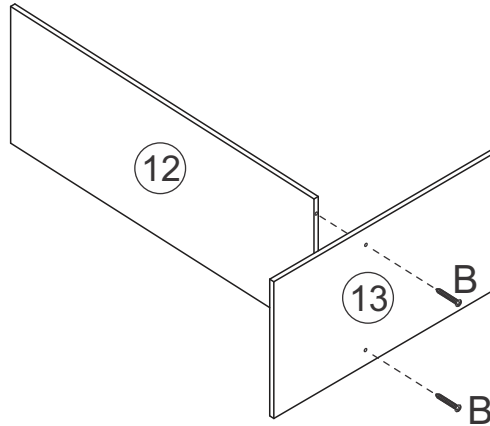

02

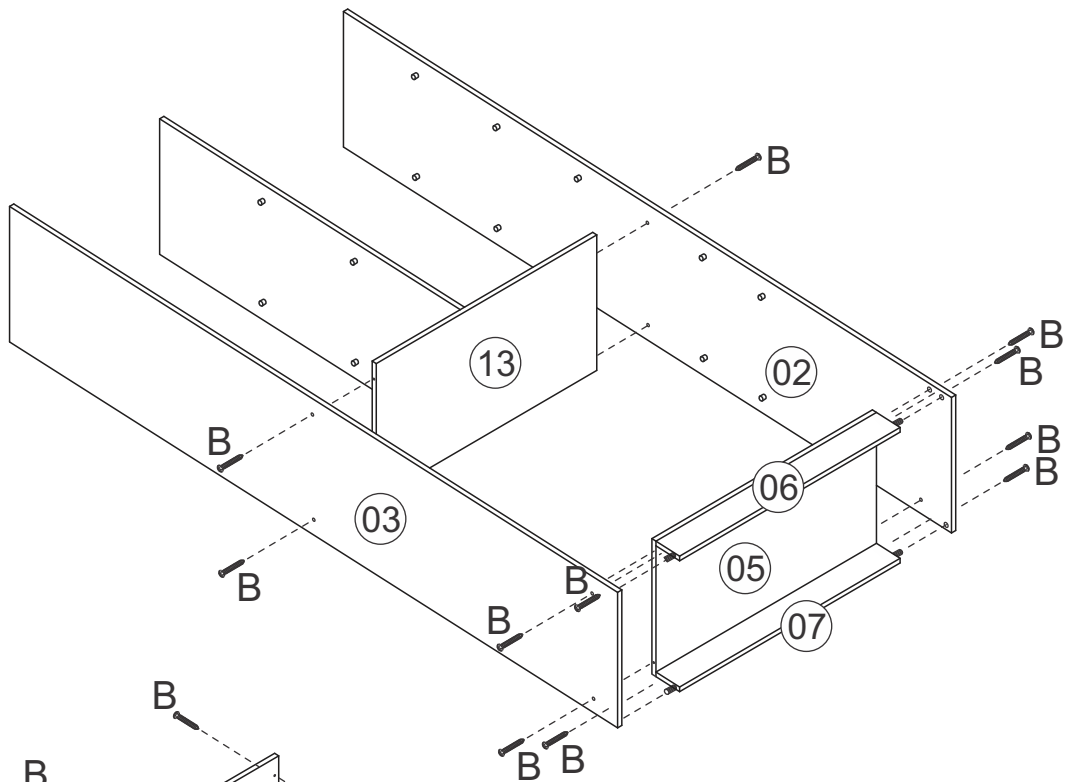

03

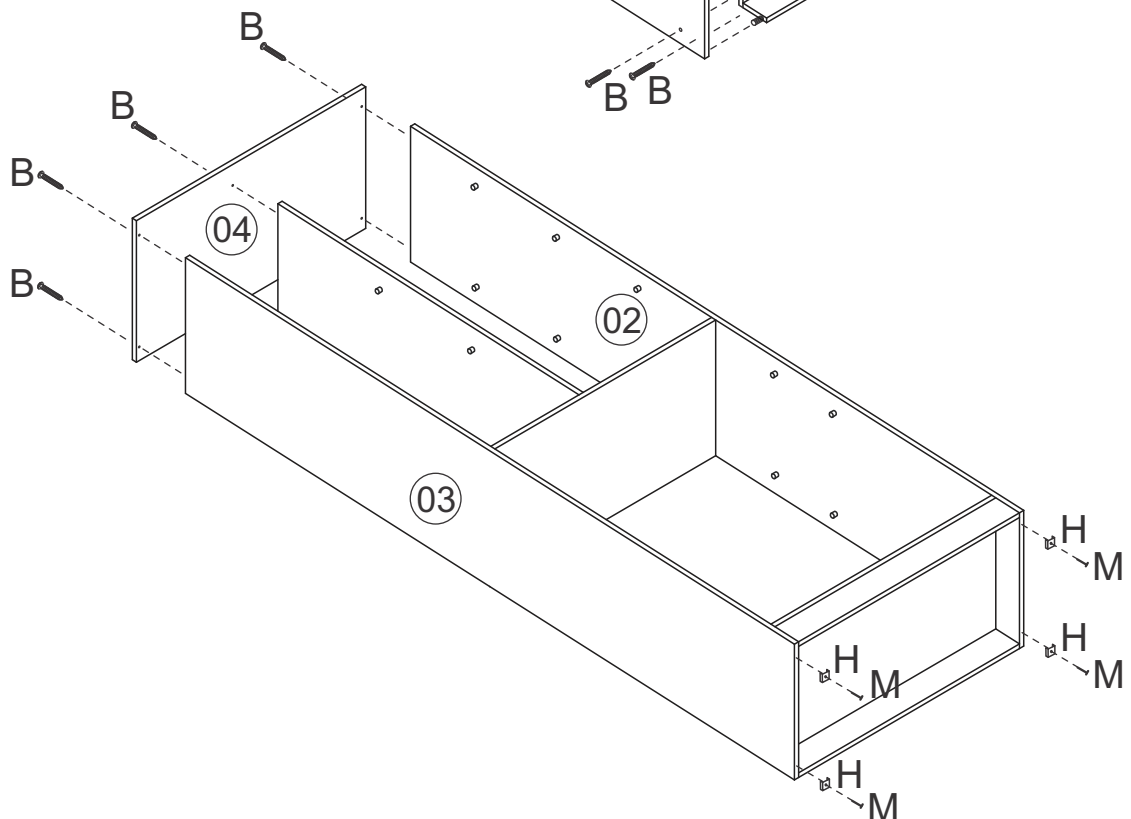

04 Montagem/Montaje/Assembly

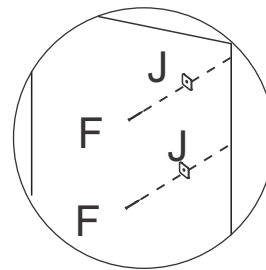
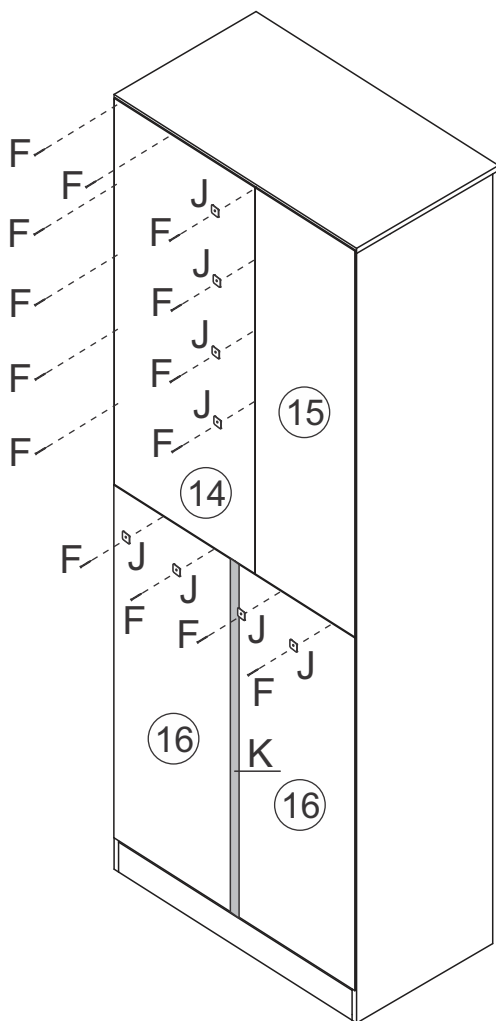

*Usar o prego (F) e a junção (J) a cada 150mm
 *Usar el clavo (F) y la junta (J) cada 150mm
 *Use the nail (F) and the joint (J) every 150mm

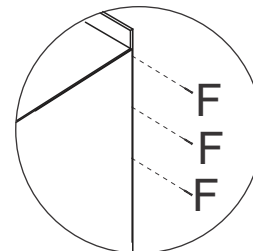

*Colocar um prego (F) a cada 100mm
 *Colocar un clavo cada (F) 100mm
 *Place a nail every (F) 100mm

05

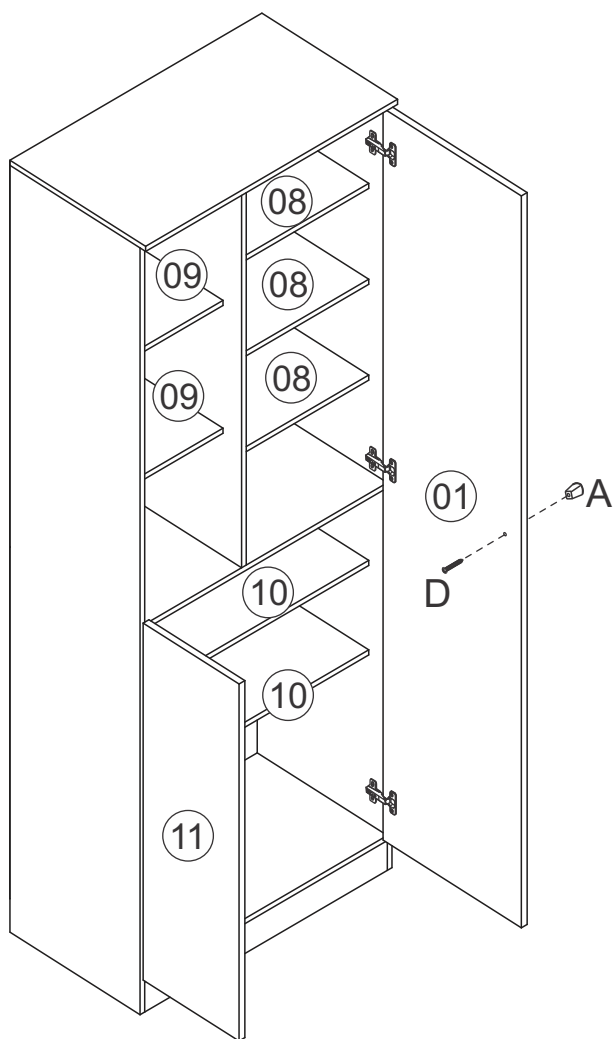
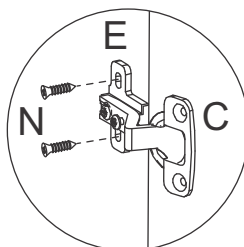

Fixação na parede
 Fijación en la pared
 Wall mounting

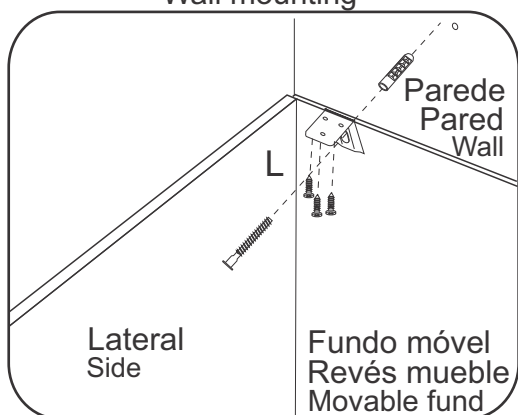

*Fixar a cantoneira na parte interna do móvel.
 Fijar la pieza «L» en el interior del mueble.
 Attach an angle bracket to the inside of the furniture.

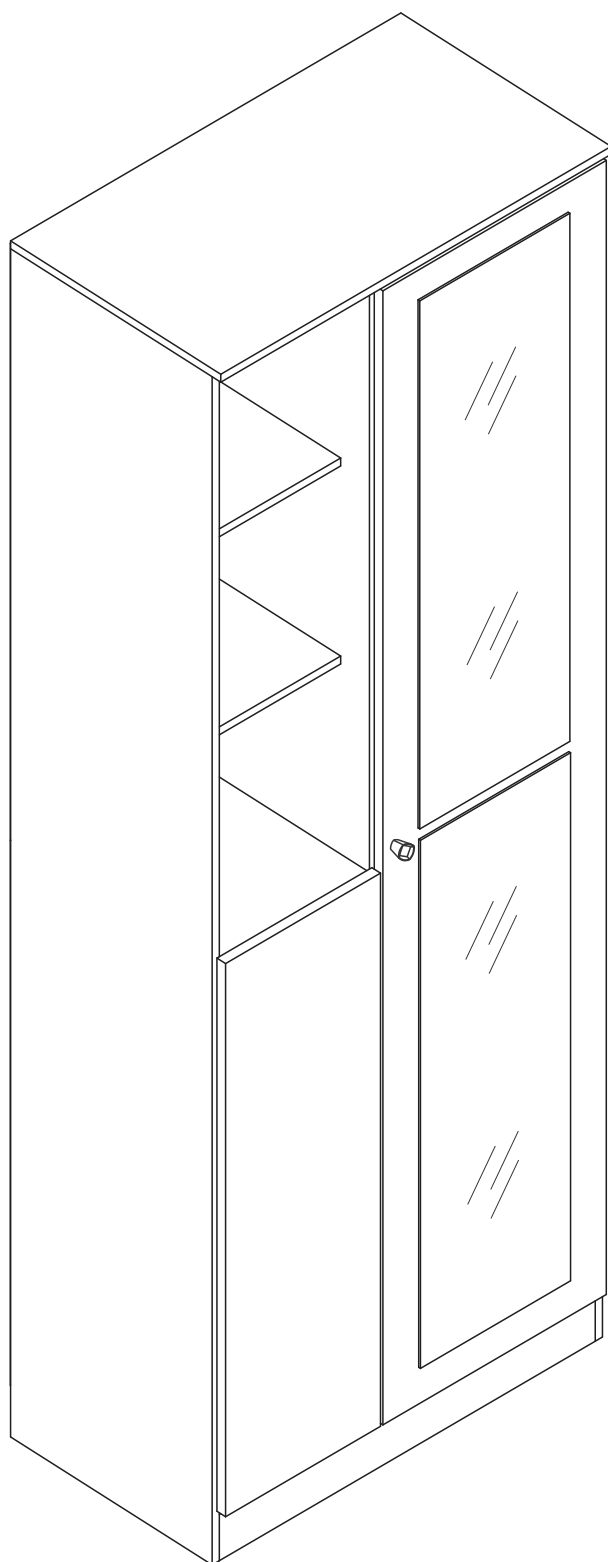

-(VERIFICAR SE O ESPELHO ESTA BEM FIXADO, CASO FOR NECESSÁRIO, AJUSTAR O MESMO).
-(CONSULTAR SI EL ESPEJO ES FIJO, SI ES NECESARIO AJUSTARLO).
-(CHECK IF THE MIRROR IS FIXED, IF NECESSARY, ADJUST IT).

Limpeza/Limpieza

- ☞ Use um pano levemente umedecido com água, seguido de pano seco.
- ☞ Use solamente un paño húmedo con agua y después un paño seco.
- ☞ Use a cloth slightly dampened with water, followed by a dry cloth.
- ☞ Nunca utilize produtos químicos ou abrasivos.
- ☞ No utilice productos químicos o abrasivos.
- ☞ Never use chemical or abrasive products.