

DIMENSÕES DO PRODUTO / PRODUCT DIMENSIONS / DIMENSIONS PRODUCT - **WxDxH / LxPxA - 1350X 300X 210 MM**

PEÇAS NUMERADAS / NUMBERED PARTS / PIEZAS NUMERADAS

EX: 1915X-X 04 (peça/ piece/ pieza number)

TV até 55"

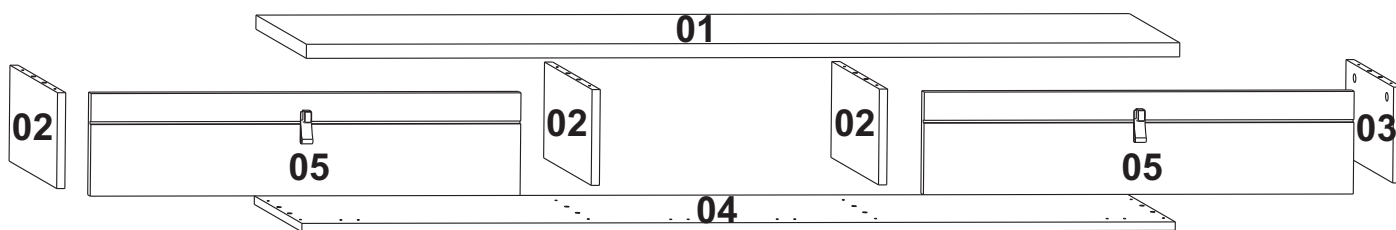
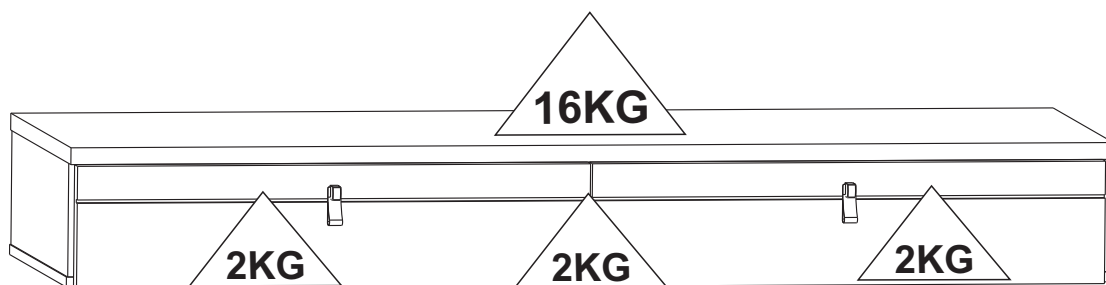

ATENÇÃO / ATTENTION / ATENCION

Nunca utilizar óleos, lustra móveis, produtos abrasivos, saponáceos, esponja de aço e outros.

Never use oils, furniture polish, abrasive products, soaps, steel sponge and others.

Nunca use aceites, pulimentos, abrasivos, jabones, esponja de acero y otros.

CUIDADOS ESPECIAIS/ SPECIAL CARE/ CUIDADOS ESPECIALES

- Evitar expor o móvel ao sol, e em lugares úmidos.
- Limpar com flanela seca ou com pano levemente umedecido em água.
- Avoid exposing the furniture to the sun, and in damp places.
- Clean with dry flannel or lightly cloth moistened with water.
- Evite exponer los muebles al sol y en lugares húmedos.
- Limpiar con franela seca o un paño ligero, humedecido con agua.

Ferramentas necessárias (não fornecidas) Necessary tools (not provided) Herramientas Necesarias (No proporcionadas)

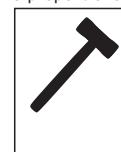

MONTAR O PRODUTO SOBRE A EMBALAGEM, EVITANDO DANOS NA PINTURA. ACONSELHAMOS QUE A MONTAGEM DO PRODUTO SEJA POR UM PROFISSIONAL.

SETUP THE PRODUCT ON TOP OF THE PACKAGING, AVOIDING DAMAGE TO THE PAINT. WE RECOMMEND THAT THE INSTALLATION IS DONE BY A PROFESSIONAL.

MONTAR EL PRODUCTO EN EL PAQUETE, EVITAR LESIONES EN PINTURA. AVISAMOS QUE EL MONTAJE DEL PRODUCTO SEA UN PROFESIONAL.

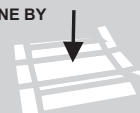

MEDIDA UTILIZADA EM MM/ UNIT MEASURE USED IS MILLIMETERS (MM)

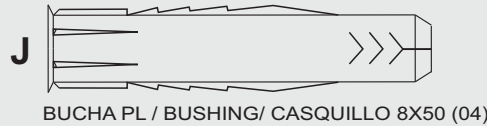
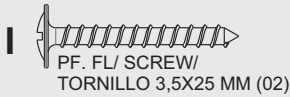
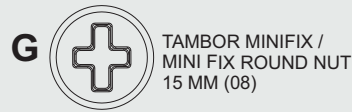
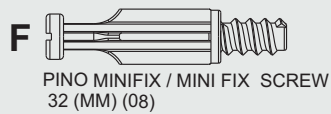
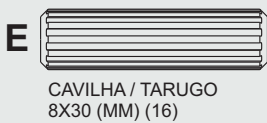
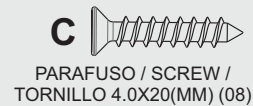
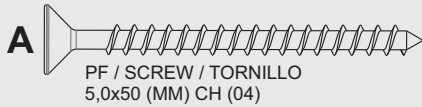

ITEM		DESCRIÇÃO DA PEÇAS / DESCRIPTION OF PARTS / UNIT MEASURE USED IS MILLIMETERS (MM)	CORES PRUDUTO/ COLORES PRODUCT/ COLORES PRODUCTO						
COD. CODE	Nº		MEDIDAS / MEASURES (MM)	QUANT AMOUNT CANTIDAD	TIPO TYPE	BRANCO/ WHITE/ BLANCO (CÓD.06)	OFF WHITE BEGE AC (CÓD.06)	PRETO/ BLACK/ NEGRO (CÓD.07)	
19383	1	TAMPO/ TOP	1599X300X25	1	MDP	01/05	01/06	01/07	
19384	2	LATERAL ESQ. DIVISORES/ LEFT SIDE DIVIDER/ LADO IZQUIERDO DIVISOR	283X170X15	3	MDP	02/05	02/06	02/07	
19386	4	LATERAL DIR/ RIGHT SIDE/ LADO DERECHO	283X170X15	1	MDP	03/05	03/06	03/07	
19387	5	BASE	1599X283X15	1	MDP	04/05	04/06	04/07	
19388	6	PORTA BASCULANTE / DOOR/ PUERTA	787X182X15	2	MDF	05/05	05/06	05/07	
15704	A	PF./ Screw/ Tornillo 5,0x50 CH		04					
438	B	PF. / Screw / Tornillo 4,0x40(MM) CH		08					
433	C	PF./Screw/ Tornillo 4,0x20(MM) CH		08					
986	D	PF./ Screw/ Tornillo 3,5x14(MM) CRR		16					
137	E	Cavilha / Wooden Dowel / Tarugo 8x30(MM)		16					
532	F	Pino Minifix /Minifix Screw 32(MM)		08					
508	G	Tambor Minifix / Minifix Round Nut 15(MM)		08					
12734	H	Tapa F. Ades./Holer Sticker/Pegatina de Agugero 18 mm)		08		BRANCO			
13877							GELO		
13363								PRETO	
8233	I	PF. / Screw / Tornillo 3,5x25(MM) CH		02					
2922	J	Bucha Pl/ Bushing/ Casquillo 8X50 Cinza		04					
18030	K1/K2	Dobradiça Metal/Hinge/ Bisagra AL6 25 (MM) Baixa		04					
17498	L	Cantoneira Metal/ Metallic Corner/ Esquina Metálica 60x60x2 (MM)		04					
3441	M	Amortecedor/ Pu Bumber/ Parachoques		04					
18587	N	Puxador TORO AKEO/ Handle/ Manija 27X15X10XMM		02					
		Certif. de Garant./ Warranty Certif.		01					

PREPARAÇÃO DE PEÇAS/ PARTS PREPARATION/ PREPARACION DE PIEZAS

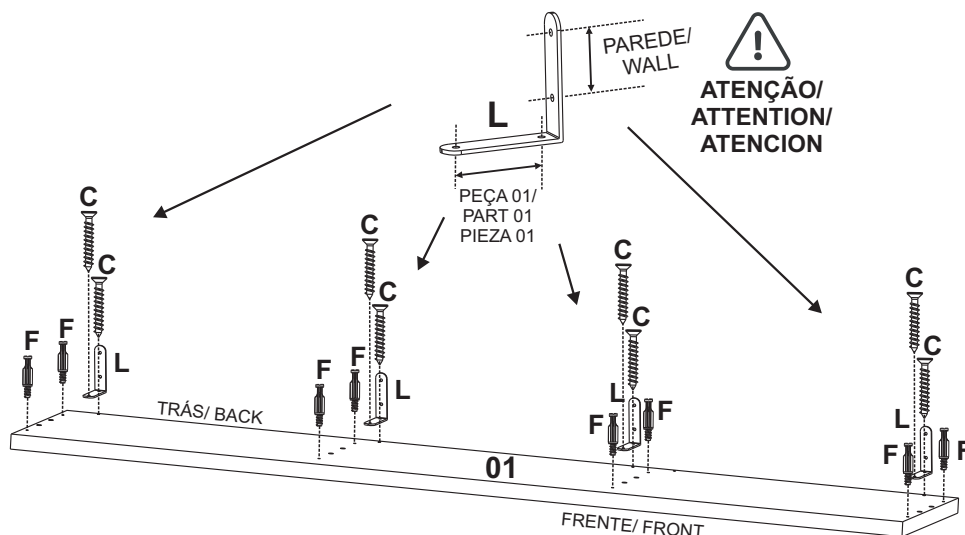
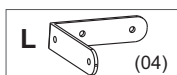
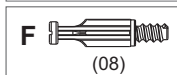
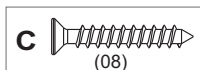

PREPARAÇÃO DE PEÇAS/ PARTS PREPARATION/ PREPARACION DE PIEZAS

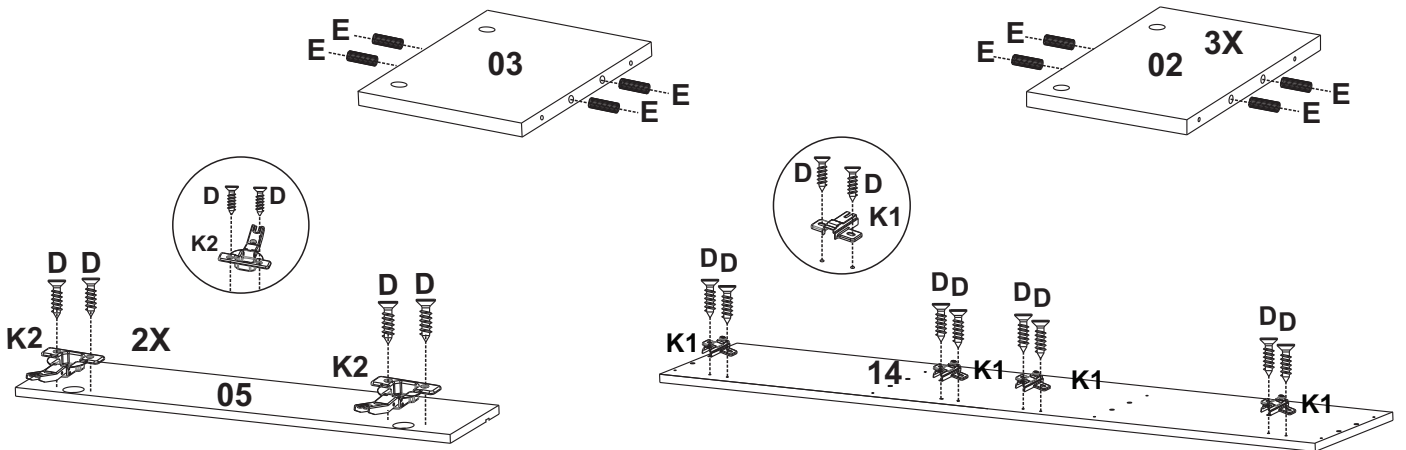
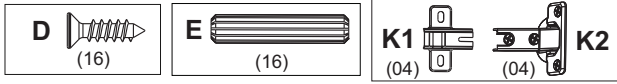

Obs: As peças pintadas nos passos são apenas ilustrativas. The parts painted in the steps are illustrative only. Las partes pintadas en los pasos son solo ilustrativas.

1

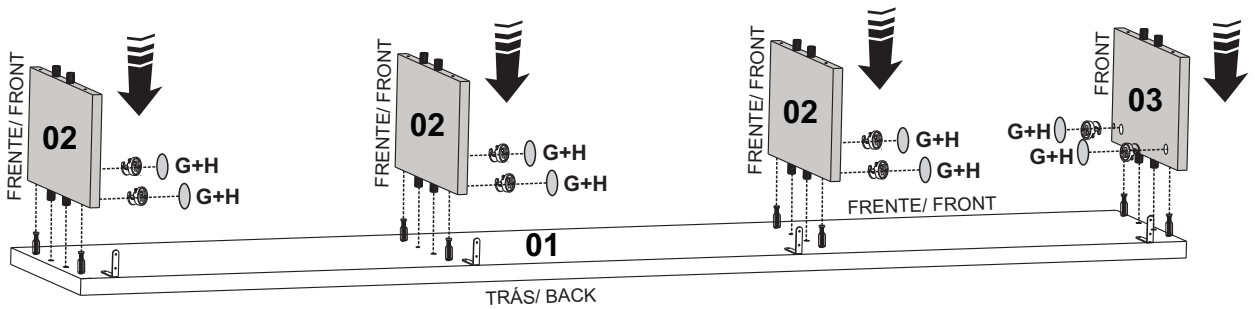

G=08
H=08



2

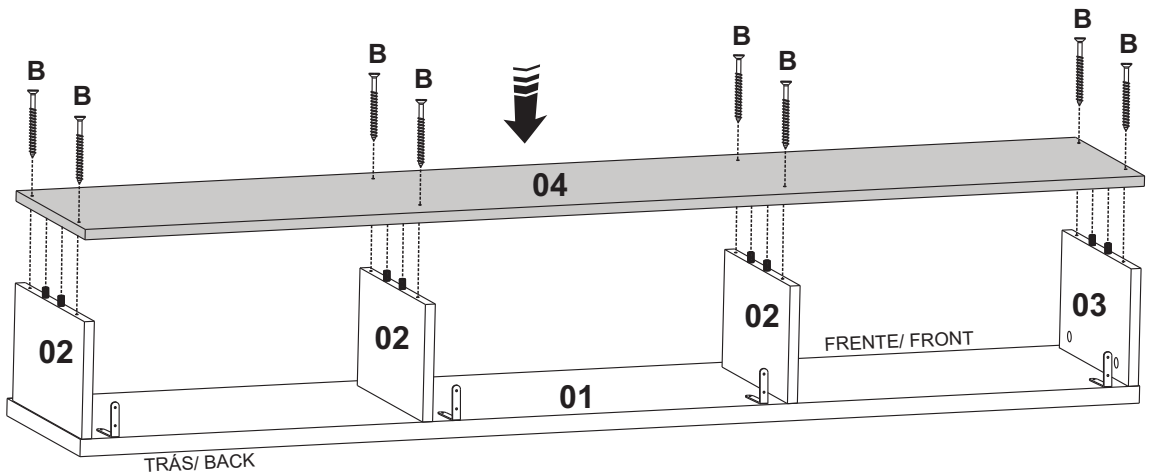
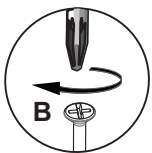

B=08

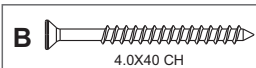

FIXAÇÃO PAREDE/ WALL FIXING/ FIJACIÓN A LA PARED



ATENÇÃO/ ATTENTION/ ATENCION
 A ALTURA PARA FIXAR O RACK É OPCIONAL.
 THE HEIGHT TO FIX THE TV RACK IS OPTIONAL.
 LA ALTURA PARA FIJAR EL RACK DEL TV ES OPCIONAL

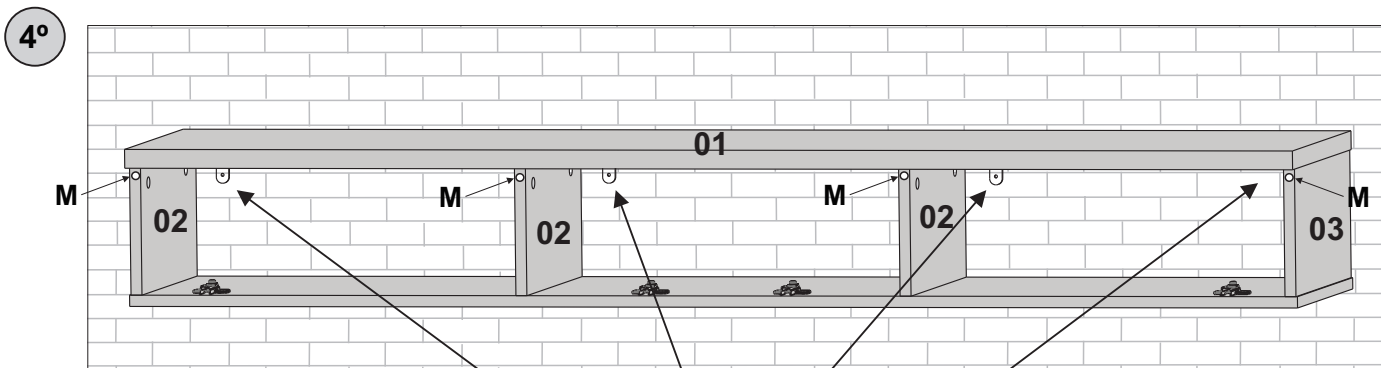
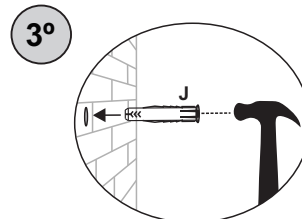
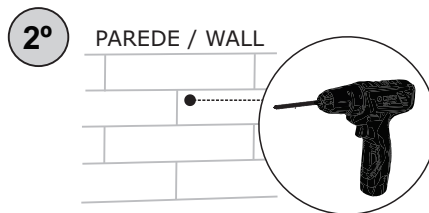
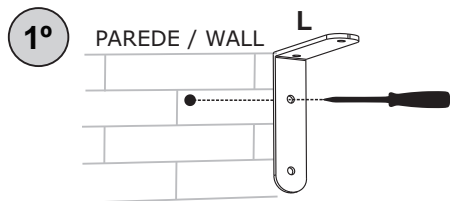

PEÇA/ PART/ PIEZAS

01

A

J

L

PAREDE/ WALL

A=04
 J=04
 M=04

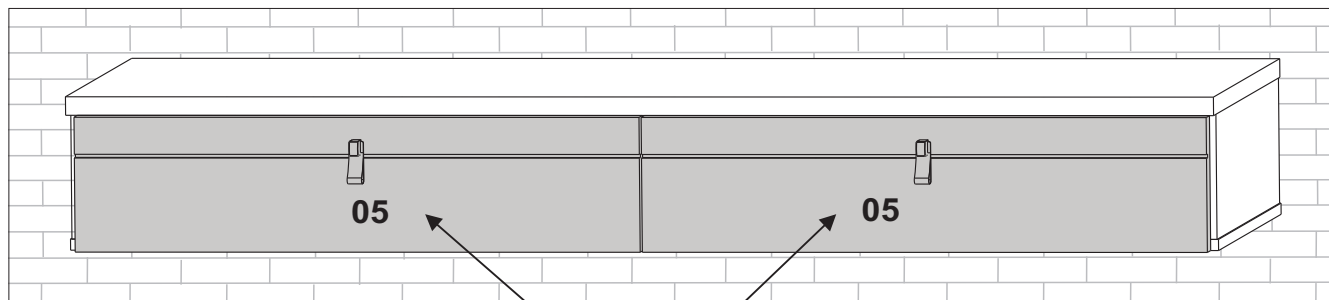
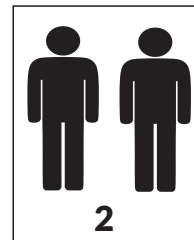
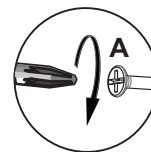
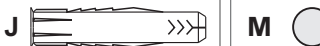
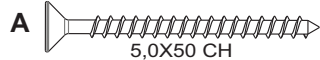

K1 K2

ENCAIXAR/ TO FIT IN/ ENCAJAR

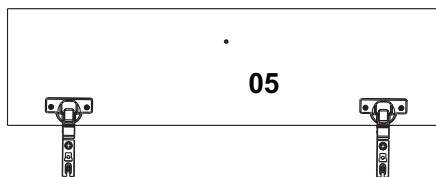
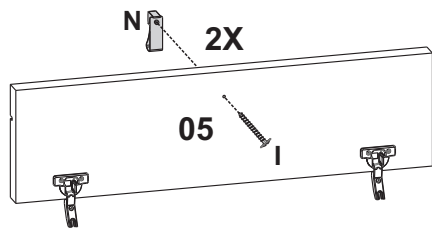

REGULAR/
 ADJUST/ AJUSTE

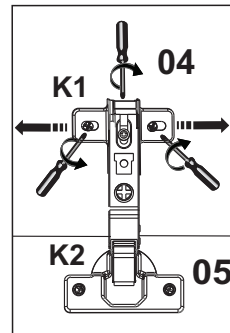

I=02
 N=02



NOTA / NOTE Não nos responsabilizamos por acidentes, se a instalação do móvel não estiver com os procedimentos deste Manual e não for realizado por pessoa habilitada.
 We are not responsible for accidents if the installation of the furniture is not in accordance with the procedures in this Manual and is not carried out by a qualified person.
 No nos hacemos responsables de accidentes si la instalación de los muebles no se realiza de acuerdo con los procedimientos de este Manual y no es realizada por una persona calificada.