

CO8220 - PANELEIRO DUPLO 0,70 M

Manual de Montagem
Assembly Instructions
Instrucción de Montaje

decibal[®]
móveis

Produto Montado
Producto final
Assembled

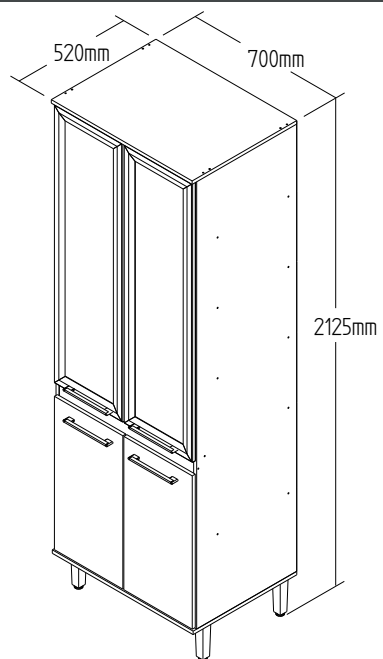

01°

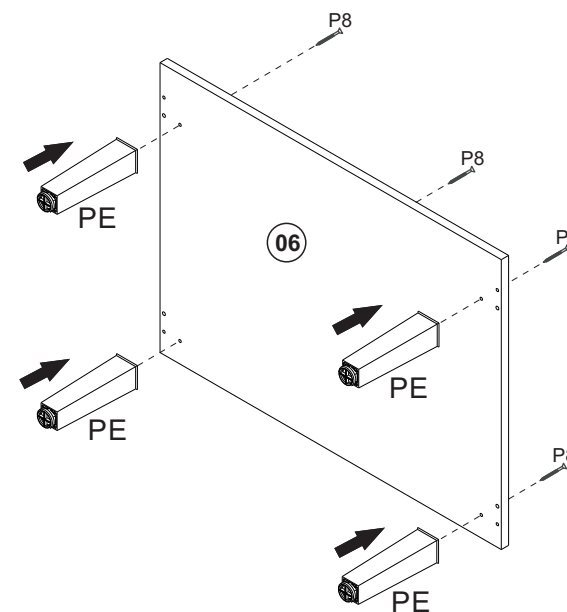

02°

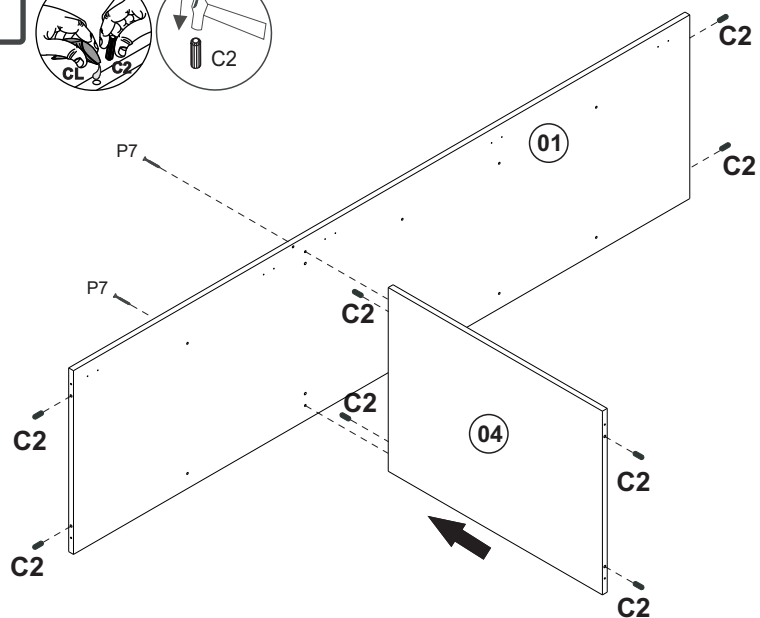
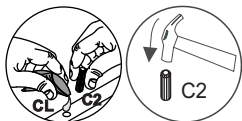

03°

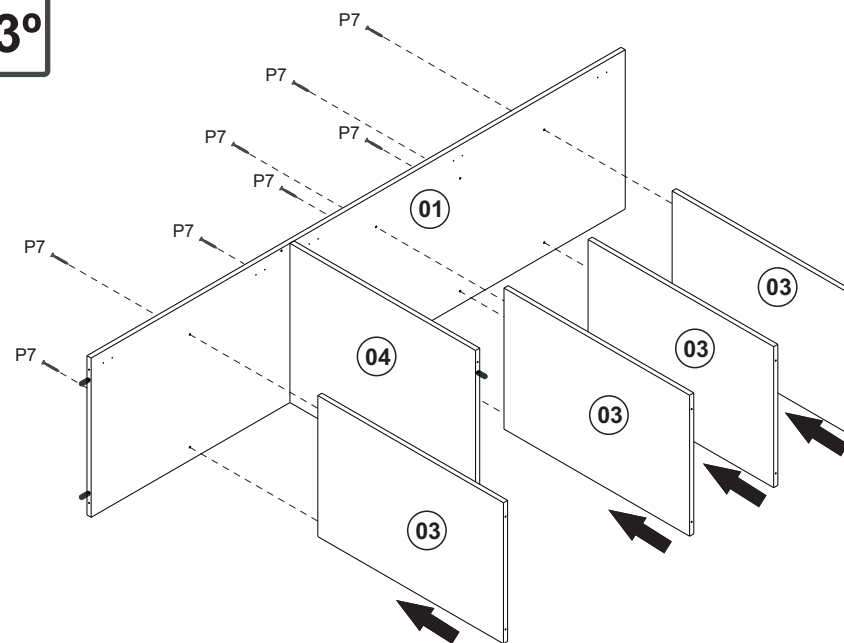

CO8220 - PANELEIRO DUPLO 0,70 M

Manual de Montagem
Assembly Instructions
Instrucción de Montaje



04°

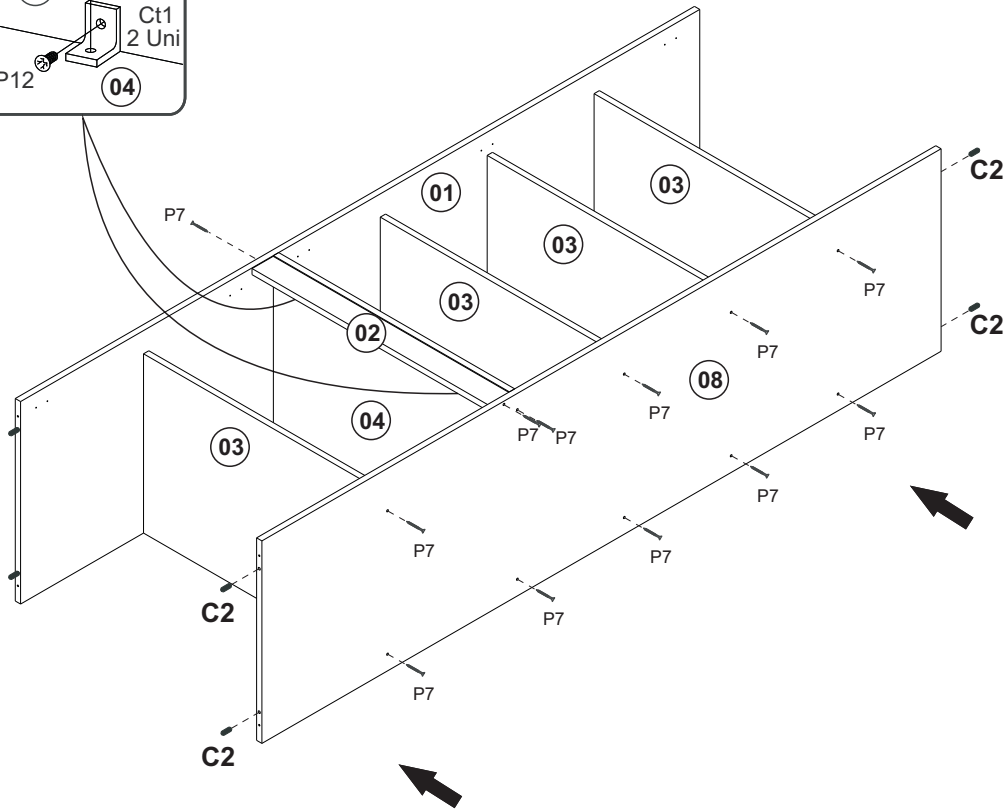
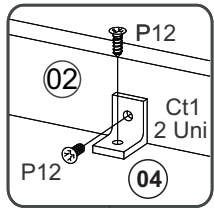
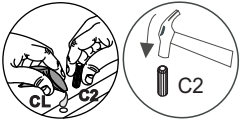

05°

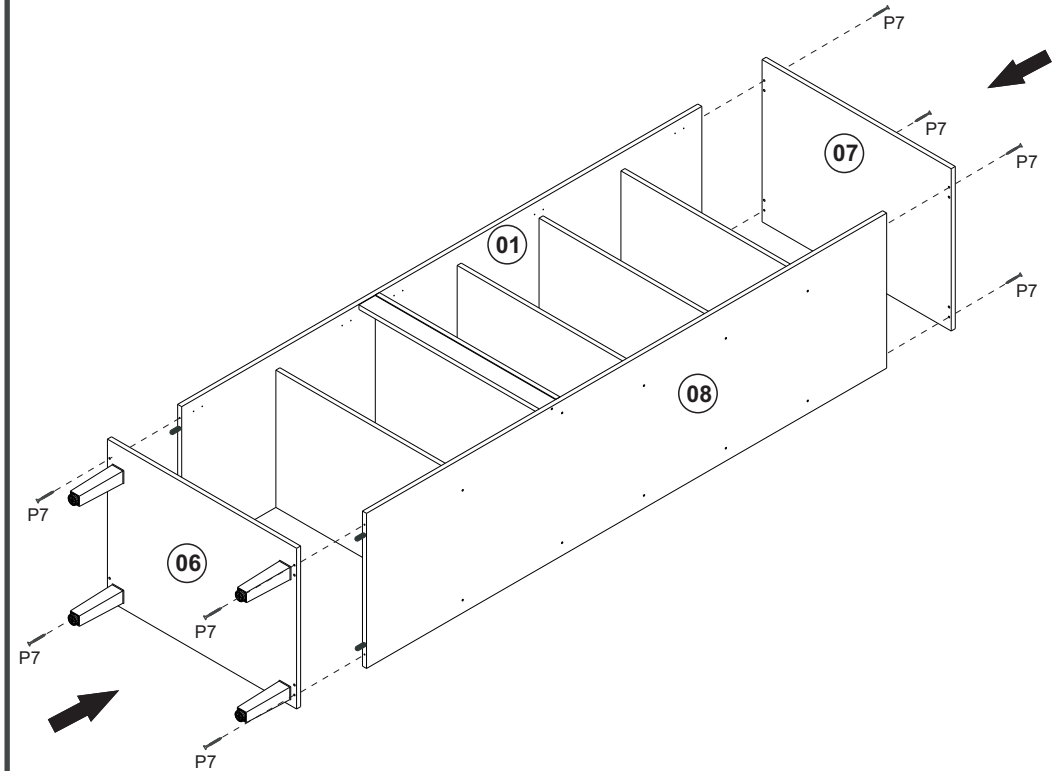
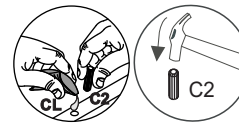

CO8220 - PANELEIRO DUPLO 0,70 M

Manual de Montagem
Assembly Instructions
Instrucción de Montaje



06°

COSTA/REVÉS/BACK

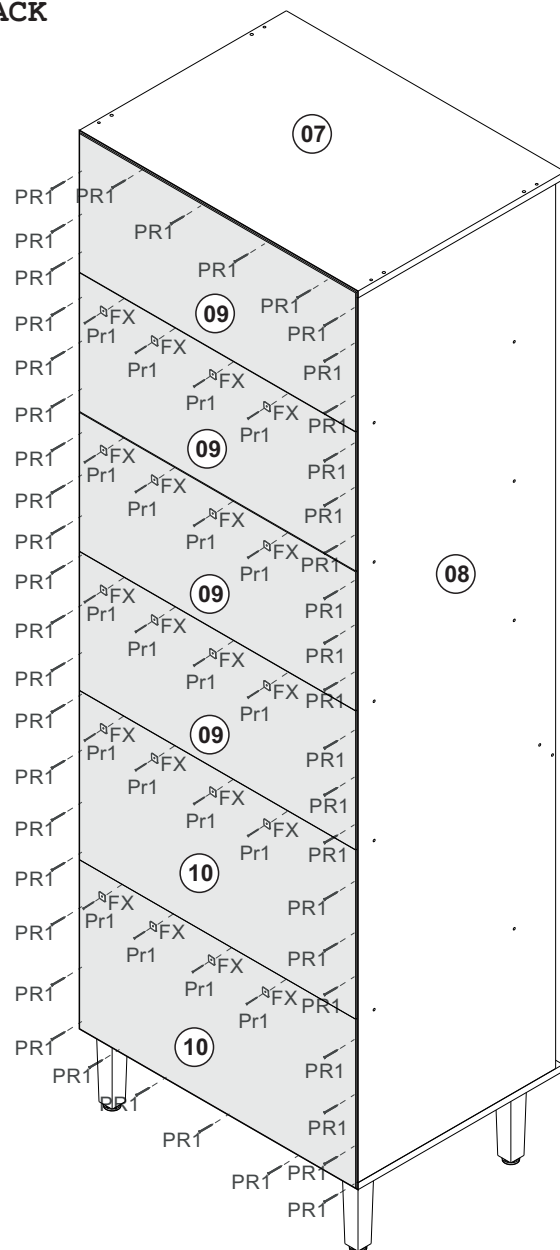
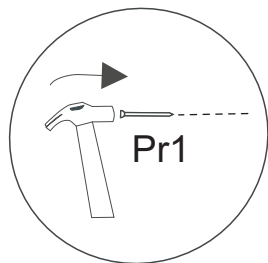

07°

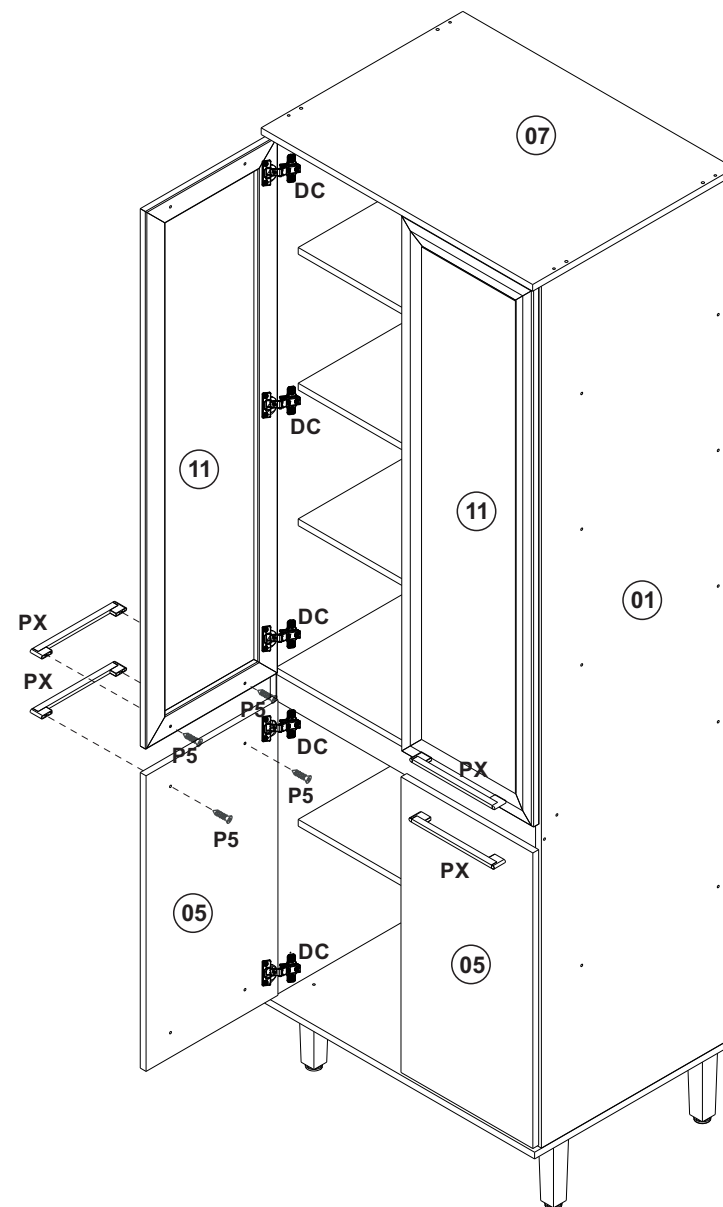
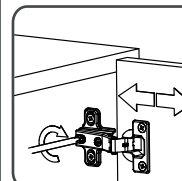
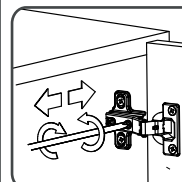
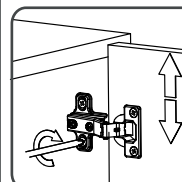
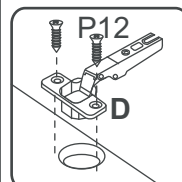
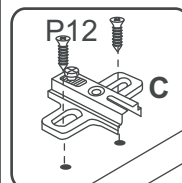

CO8220 - PANELEIRO DUPL0 0,70 M

Manual de Montagem
Assembly Instructions
Instrucción de Montaje

decibal[®]
móveis

08°

PESO SUPORTADO/PESO SOPORTADO/WEIGHT SUPPORTED

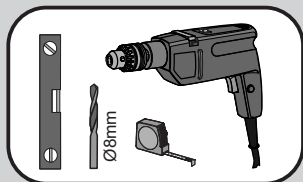

Fixação parede
Fixed in the wall

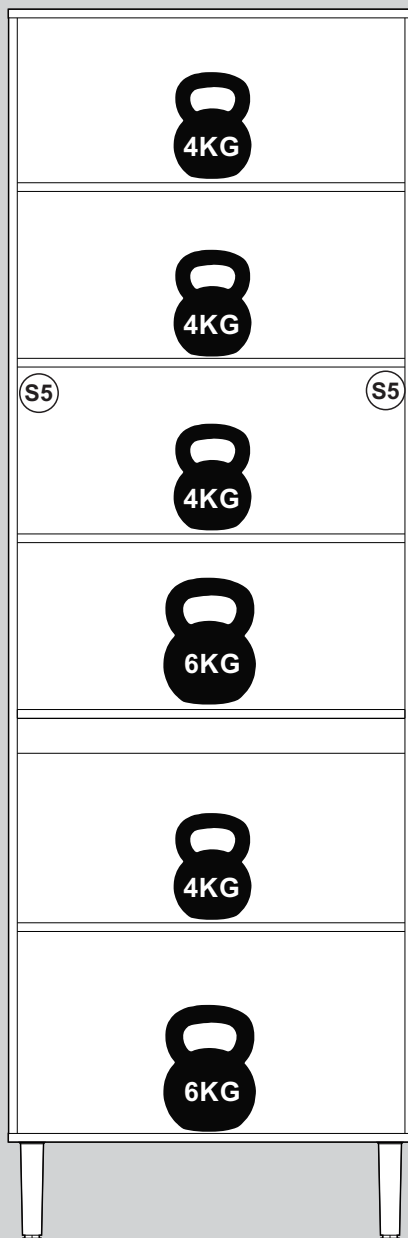
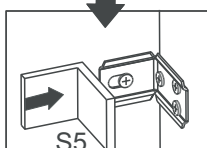
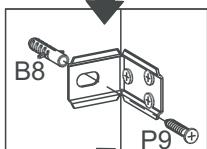
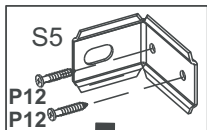

Relação de Peças/ Relación de Piezas/Parts List

N°	CÓDIGO/CODE	DESCRIÇÃO/DESCRIPCIÓN/DESCRIPTION	QTD/CANT	VOL.
1	0549100	LATERAL DIR/LATERAL/SIDE 1925X497X15MM	1,00	1
2	0549103	TRAVESSA FRT 669X60X15MM	1,00	1
3	0549104	PRATELEIRA MENOR/ESTANTE/SHELF 669X420X15MM	4,00	1
4	0549208	BASE MEIO 669X497X15MM	1,00	1
5	0549105	PORTA/PUERTA/DOOR 660X340X15MM	2,00	1
6	0549099	BASE 700X515X15MM	1,00	1
7	0549102	TAMPO/TAPA/TOP 700X520X15MM	1,00	1
8	0549101	LATERAL ESQ/LATERAL/SIDE 694X302X2,8MM	4,00	1
9	0549107	COSTA MENOR/REVÉS/BACK 1925X497X15MM	2,00	1
10	0549106	COSTA MAIOR/REVÉS/BACK 694X302X2,8MM	2,00	1
11	11934	PORTA VIDRO/PUERTA/DOOR 1200X340X18MM	2,00	2

www.decibal.com.br

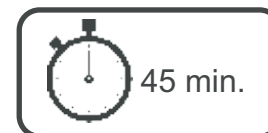

ATENÇÃO!!!! montadores e consumidores
* Ajustar o torque da parafusadeira para não danificar as peças escareando o parafuso *
ATENCIÓN!!!! montadores e consumidores
* Ajuste el torque del destornillador para no dañar las piezas avallando el tornillo *
ATTENTION!!!! assemblers and consumers
* Adjust the torque of the screwdriver so as not to damage the parts by countersinking the screw *

Ferramenta necessárias
Necessary tools
Herramientas necesarias



ATENÇÃO!!!! montadores e consumidores
* Para limpar o móveis utilize somente um pano úmido (umedecido em água pura ou água com sabão neutro). Depois, passe um pano seco. Evite a umidade excessiva.
* Evite usar álcool, água sanitária, detergente e outros produtos químicos, mesmo diluídos em água. Não utilize produtos abrasivos de nenhuma espécie

ATENCIÓN!!!! montadores e consumidores
* Para limpiar el mueble utilice solamente un paño húmedo (humedecido con agua limpia o con un jabón suave). A continuación, utilice un paño seco. Evite el exceso de humedad.
* Evite uso de alcohol, hipoclorídoro solución basada, detergente y otros productos químicos, mismo diluídos en agua. No utilice productos abrasivos de ningún tipo.
ATTENTION!!!! assemblers and consumers
* To clean the furniture, use only a damp cloth (humidify it only in pure water ou water and neutral soap). After, use a dry cloth. Avoid excessive humidity.
* Avoid using alcohol, bleach, detergent and other chemical products, even diluted in water. Do not use any kind of abrasive cleaning agents to clean the furniture.
The use of such products may jeopardize the final characteristics of the furniture.

CO8220 - PANELEIRO DUPL0 0,70 M









Manual de Montagem
Assembly Instructions
Instrucción de Montaje













Ferragens/ Herrajes/ Hardware

escala (1:1)

escala (N/A)

LEGENDA	DESCRIÇÃO/DESCRIPCIÓN/DESCRIPTION	CÓDIGO	QUANT.
P7	 PARAFUSO/TORNILLO/SCREW 4X45	01318	30
PR1	 PREGO/CLAVO/NAIL 10X10	01330	95
C2	 CAVILHA/TARUGO/DOWEL 6X30 MM	01211	13
P8	 PARAFUSO/TORNILLO/SCREW 5X45	01320	04
PU	 PARAFUSO UNIÃO/UNIÓN DE TORNILLO /SCREW UNION	01495	02
P5	 PARAFUSO/TORNILLO/SCREW 3,5X25	09955	08
P12	 PARAFUSO/TORNILLO/SCREW 3,5X13	09927	48
P9	 PARAFUSO/TORNILLO/SCREW 6X50	03827	02

LEGENDA	DESCRIÇÃO/DESCRIPCIÓN/DESCRIPTION	CÓDIGO	QUANT.
CL	 COLA/PEGAMENTO/GLUE	01213	01
ET	 ETIQUETA LOGO DECIBAL/LABEL DECIBAL	01312	01
B8	 BUCHA/BUJE/BUCHING 8mm	01311	02
Ct1	 CANTONEIRA/PIEZA L/SHEET	03077	02
DC	 DOBRADIÇA/BISAGRA/HINGE D=35mm C=0mm	09449	10
S5	 SUPORTE AÉREO/APOYO AÉREO/AIR SUPPORT Wood 09647	03828	02
Fx	 FIXADOR COSTA/FIJADOR FONDO/FIXER COAST	01331	25
PX	 PUXADOR/ PEGADOR/ HANDLE	11020	04
AD	 ADESIVO/ADHESIVO/ADHESIVE 15mm Wood 09929 Naturalle 09963		24
PE	 PÉ/PATA/FOOT (170mm)	CINZA 11121	04

Medida em mm

