

MANUAL DE MONTAGEM / ASSEMBLY INSTRUCTIONS / PLANO DE ARMADO

Antes de montar o móvel, leia com atenção o manual de montagem!
Before assembling the furniture, carefully read the assembly instructions!
Antes de armar el mueble, lea con atención el manual de ensamble!

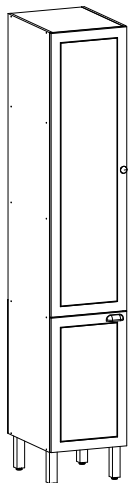

Ref.: 1357

geniaflex
ambientes incríveis para todos

Parabéns! Você comprou um produto de excelente qualidade, fabricado com chapa de madeira de MDP ou MDF, extraída de florestas renováveis. Possui alta resistência e design atual.

Congratulations! You have purchased a product of excellent quality, made from MDP or MDF wood veneer, extracted from renewable forests. It has high strength and current design.

Felicitaciones! Usted compró a un producto de excelente calidad, fabricado con placa de madera de MDP o MDF, proveniente de florestas renovables. Tiene alta resistencia y diseño actual.



ATENÇÃO
ATTENTION
ATENCIÓN

1) Verifique todas as peças antes de começar a montagem.

Check all parts before starting assembly.

Verifique todas las partes antes de empezar el armado.

2) Ao começar a montagem, não apoie as peças na parede.

When starting the assembly, do not support the parts on the wall.

Al empezar el armado, no apoyes las partes en la pared.

3) Ao colocar as peças e ferragens de lado, cuidado para não perde-las.

When placing parts and hardware aside, be careful not to lose them.

Al poner las piezas y herrages a parte, cuidado para no dañarlas.

4) O móvel deve ser montado no chão, para isso, use a própria caixa para proteger e não danificar o piso.

The furniture must be mounted on the floor, to do this, use the box itself to protect and not damage the floor.

El mueble suele ser armando al piso, para eso, use la propia caja para protegerlo y no dañar al piso.

5) Comece a montagem seguindo as instruções passo a passo.

Begin assembly by following the step-by-step instructions.

Comience el armado siguiendo la instrucciones paso a paso.

6) É de responsabilidade do montador seguir as intruções desse manual, que são fundamentais para a estrutura do móvel.

It's the assembler's responsibility to follow the instructions in this manual, which are fundamental to the structure of the furniture.

Es de responsabilidad del armador seguir las instrucciones de este manual, que son fundamentales para la estructura del mueble.

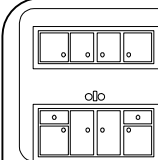

CUIDADOS
CARE
CUIDADO

1) A conservação e limpeza deve ser feita com um pano levemente umedecido com água.

Care and cleaning should be done with a cloth slightly moistened with water.

La conservación y limpieza debe ser hecha con un trapo levemente humedecido en agua.

2) Não use produtos abrasivos, como saponáceo, detergentes e esponja de aço.

Do not use abrasive products, such as soap, detergents and steel sponge.

No use productos abrasivos, como saponáceo, detergentes y esponja de acero.

3) Não use cera ou óleo para dar brilho ao móvel.

Do not use wax or oil to shine the furniture.

No use cera o aceites para darle brillo al mueble.

4) Não expor o móvel a interpéries e nem ao calor excessivo.

Do not expose the furniture to weather or excessive heat.

No exponer el mueble a interperies ni al calor excesivo.

5) Ao terminar a montagem, limpe o ambiente e o móvel.

When the assembly is finished, clean the room and the furniture.

Al terminar el armado, limpie al ambiente y al mueble.

FERRAMENTAS / TOOLS / HERRAMIENTAS



MARTELO
HAMMER
MARTILLO



CHAVE PHILLIPS
PHILLIPS SCREWDRIVER
LLAVE PHILLIPS



NAO RECOMENDAVEL
NOT ADVISABLE
NO RECOMENDABLE



MARTELO DE BORRACHA
RUBBER HAMMER
MARTILLO GOMA









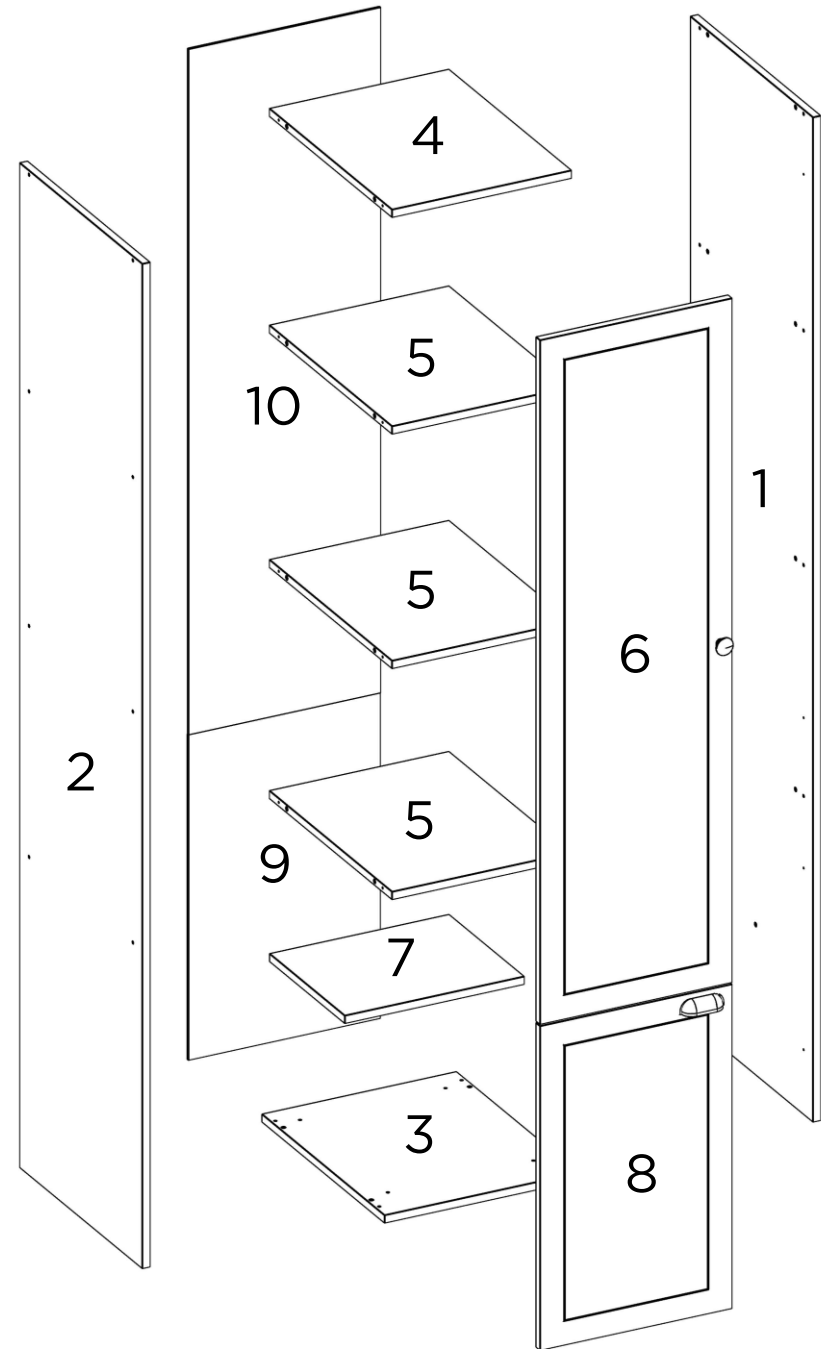



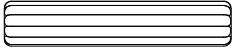

TRENA
MEASURING TAP
CINTA MÉTRICA

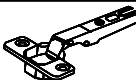
PEÇAS / PARTS / PIEZAS

Nº No Num	DESCRIÇÃO DESCRIPTION DESCRIPCIÓN	QTD QTY CANT
1	LATERAL DIREITA RIGHT SIDE PANEL LATERAL DERECHA	1
2	LATERAL ESQUERDA LEFT SIDE PANEL LATERAL IZQUIERDA	1
3	BASE BOTTOM BASE	1
4	TAMPO TOP TABLERO	1
5	PRATELEIRA FIXA FIXED PLATE REPISA FIJO	3
6	PORTA SUPERIOR UPPER DOOR PUERTA SUPERIOR	1
7	PRATELEIRA MÓVEL MOBILE PLATE REPISA MÓVIL	1
8	PORTA DOOR PUERTA	1
9	COSTA INFERIOR LOWER BACK PANEL TRASERO INFERIOR	1
10	COSTA SUPERIOR UPPER BACK PANEL TRASERO SUPERIOR	1

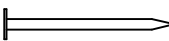

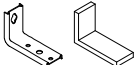
FERRAGENS / HARDWARE / HERRAJES

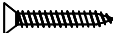
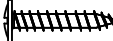
CÓD CODE COD	DESCRIÇÃO DESCRIPTION DESCRIPCIÓN	QTD QTY CANT
A	 CAVILHA WOODEN DOWEL TARUGO	20
B	 SUPORTE DE PRATELEIRA SHELF SUPPORT SOPORTE DE ESTANTES	4
C	 PARAFUSO 4X14mm SCREW 4X14mm TORNILLO 4X14mm	26
D	 CALÇO PARA DOBRADIÇA HINGE SHED CALZO DE BISAGRA	5
E	 DOBRADIÇA HINGE BIZAGRA	5
F	 PARAFUSO 5X50mm SCREW 5X50mm TORNILLO 5X50mm	5
G	 PÉ LEG PATA	4
H	 PARAFUSO 3,5X40mm SCREW 3,5X40mm TORNILLO 3,5X40mm	20
I	 PREGO NAIL CLAVO	50
J	 GARRA METÁLICA METALLIC CLAW GRAB METALICA	3
K	 SUPORTE DE FIXAÇÃO MOUNTING SUPPORT SOPORTE DE MONTAJE	1
L	 BUCHA PLÁSTICA PLASTIC BUSHING CASQUILLO PLÁSTICO	1
M	 PULLER TIRADOR	2
N	 PARAFUSO 3.5X25mm SCREW 3.5X25mm TORNILLO 3.5X25mm	5
O	 PARAFUSO 3.5X25mm SCREW 3.5X25mm TORNILLO 3.5X25mm	6

UTILIZE A RÉGUA PARA IDENTIFICAR OS PARAFUSOS
USE THE RULER TO IDENTIFY THE SCREWS
UTILICE LA REGLA PARA IDENTIFICAR LOS TORNILLOS



PESO SUPORTADO / WEIGHT SUPPORTED / PESO SOPORTADO

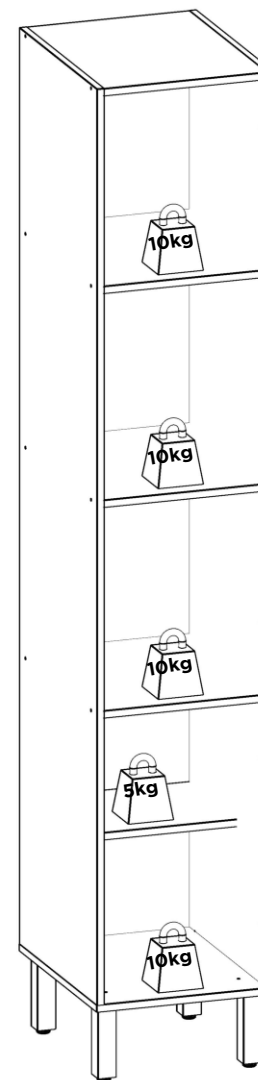

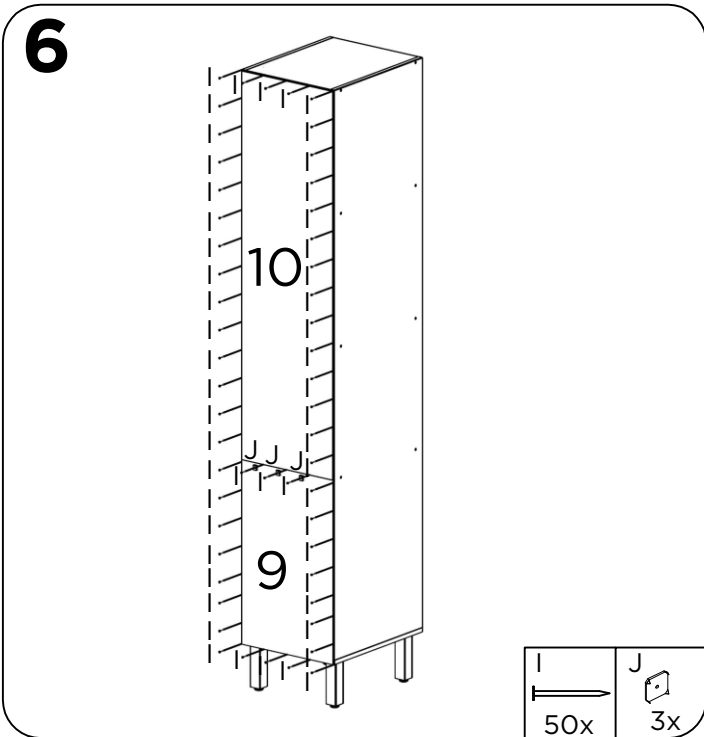
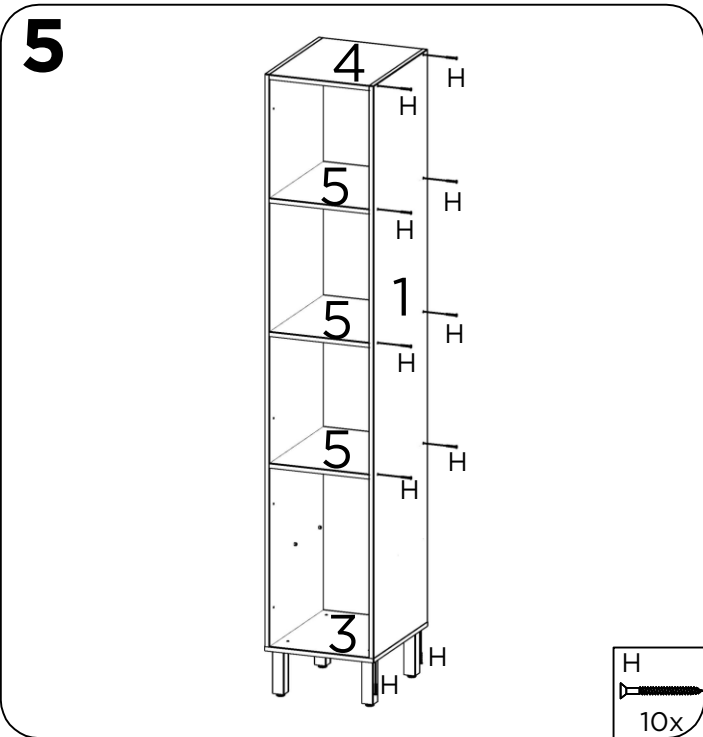
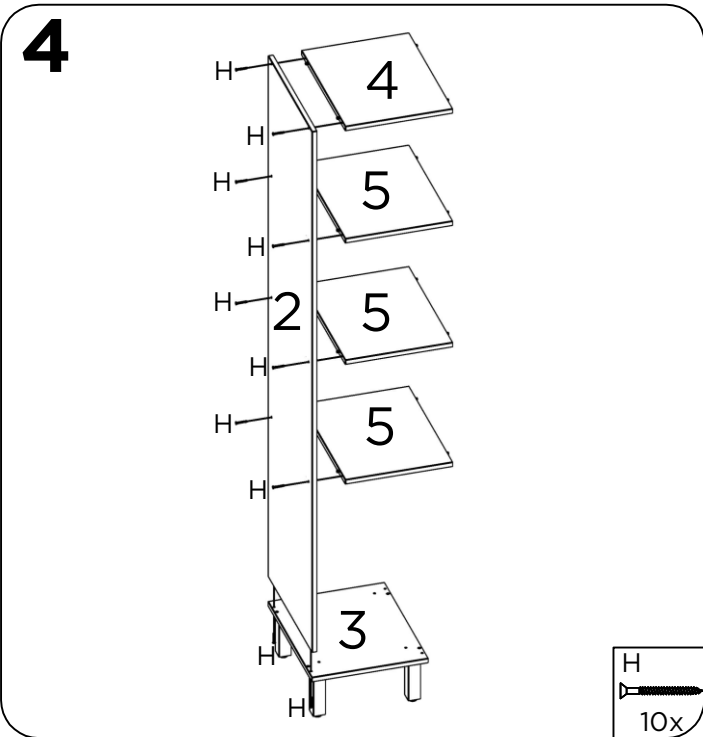
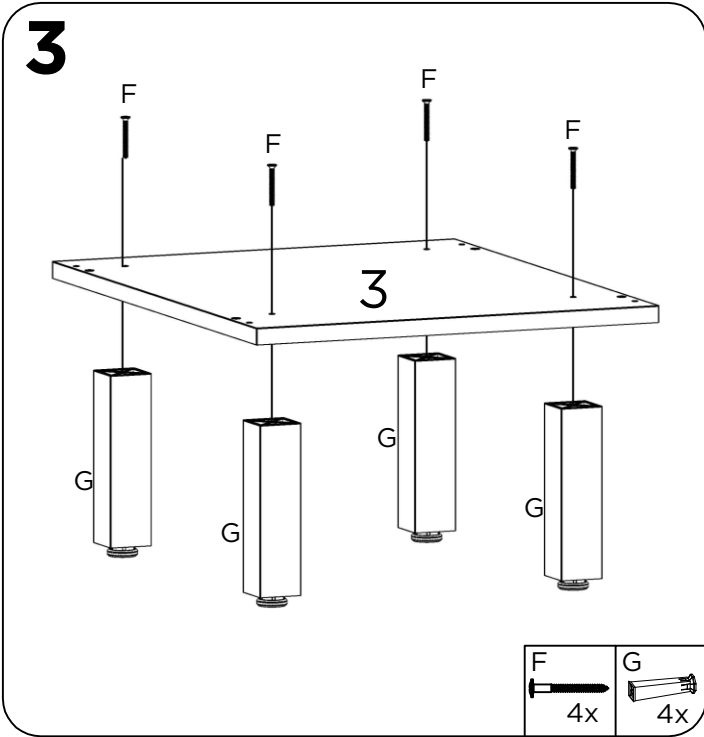
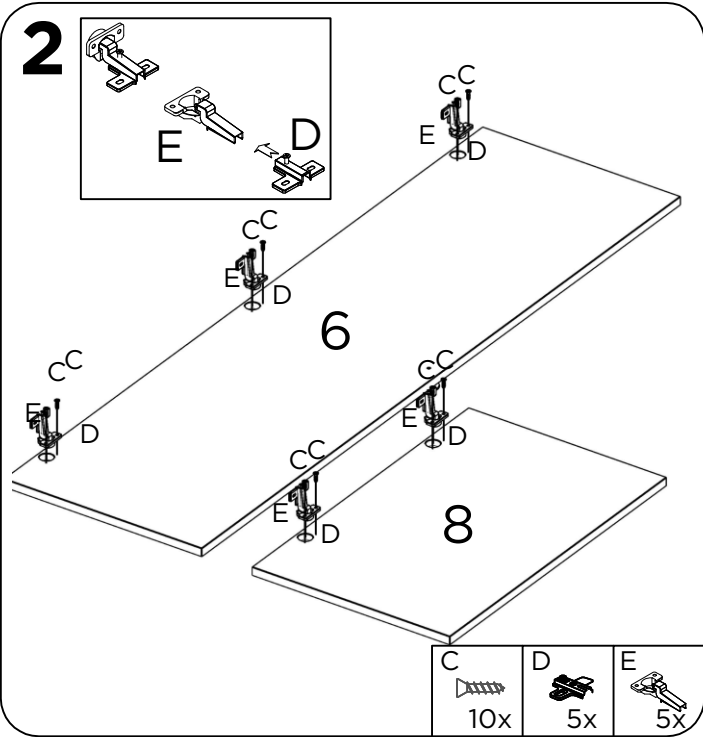
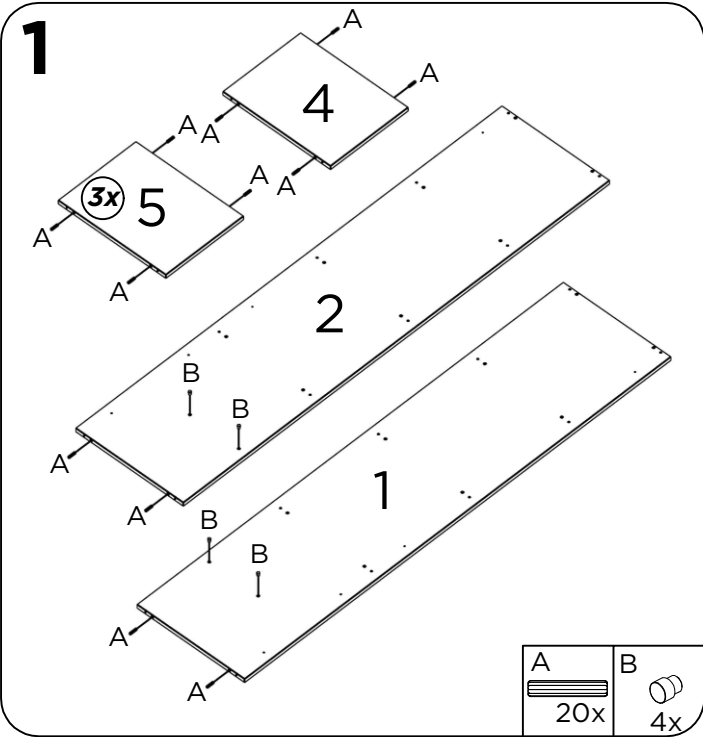

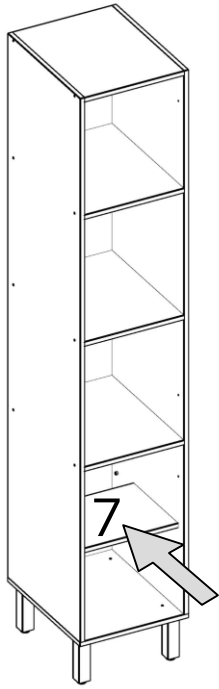
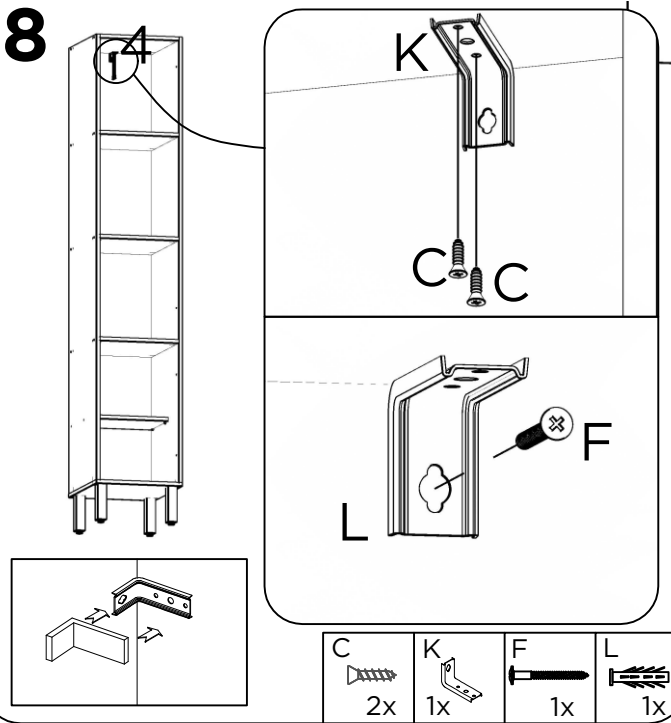
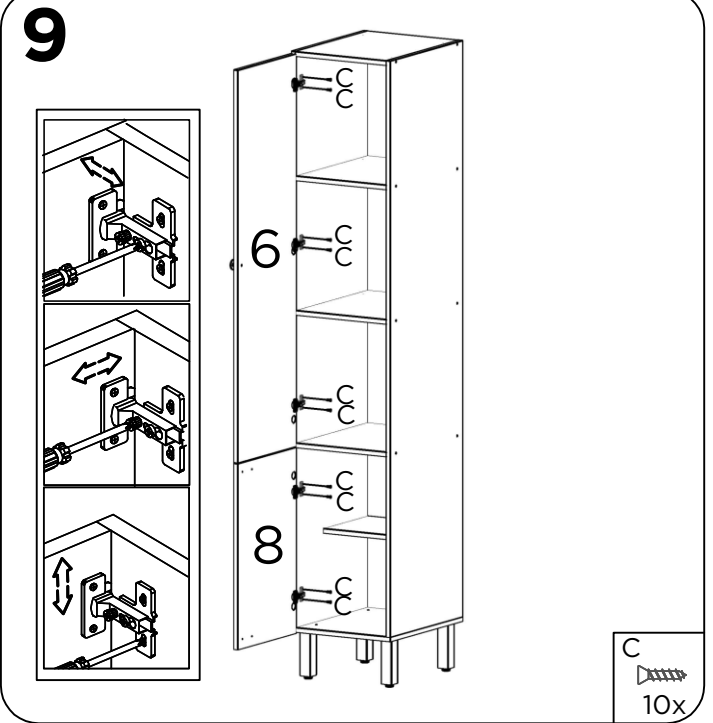
7**8****9****10**

Instalação dos puxadores conforme modelo adquirido, siga os passos no manual dos puxadores.

Instalación de las manijas según el modelo adquirido, seguir los pasos del manual de manijas.

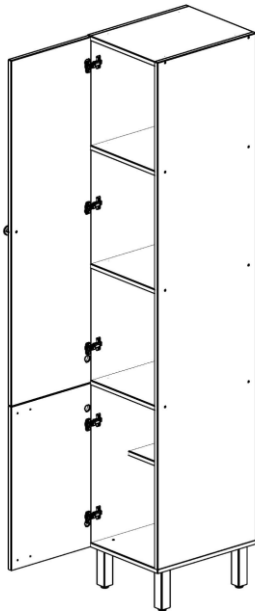
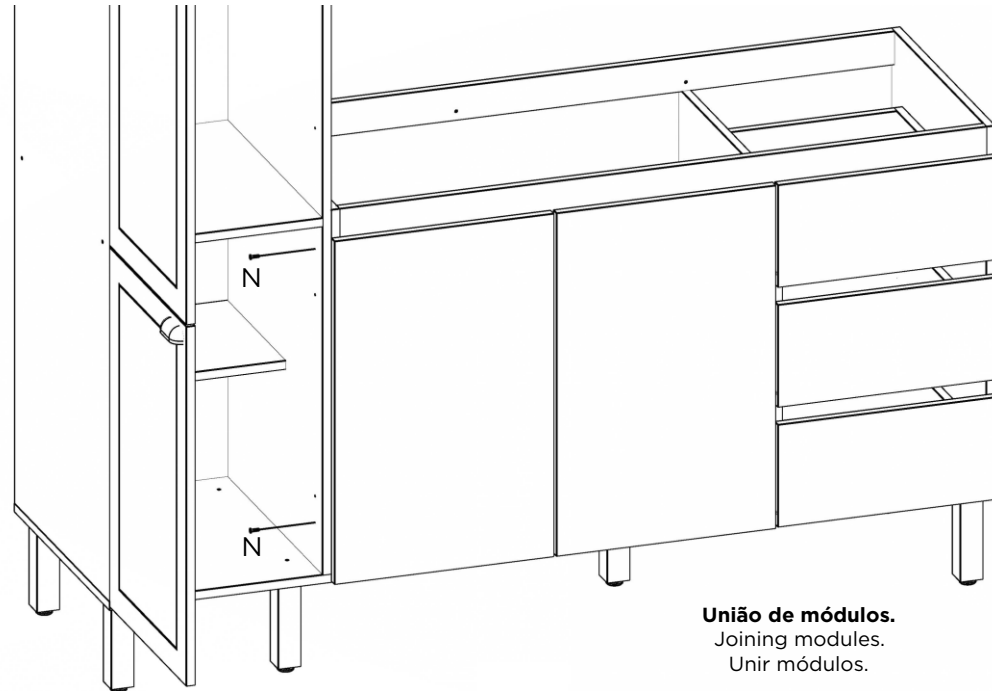
**11**

União de módulos.
Joining modules.
Unir módulos.

N
5x

P

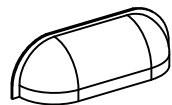
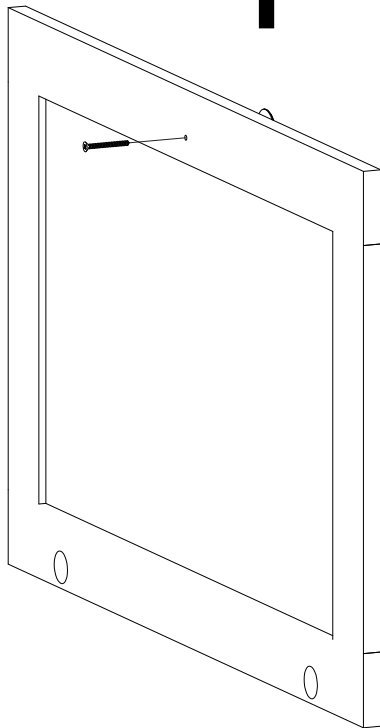

Parafuso 3,5x25mm

