

# CO6101 - PANELEIRO SIMPLES

Manual de Montagem  
Assembly Instructions  
Instrucción de Montaje

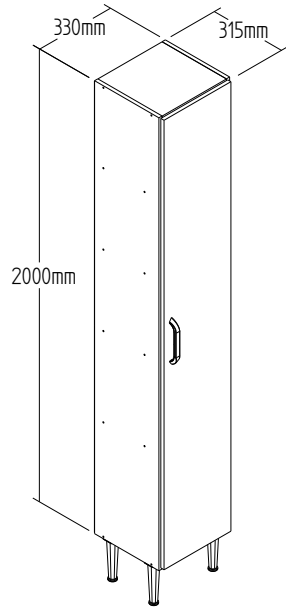

Produto Montado  
Producto final  
Assembled



1°

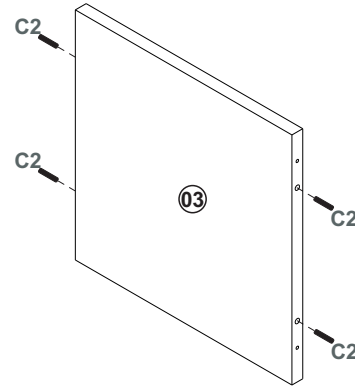

2°

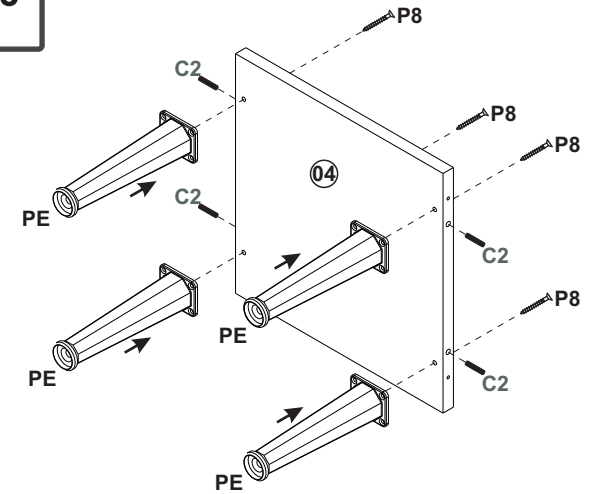

3°

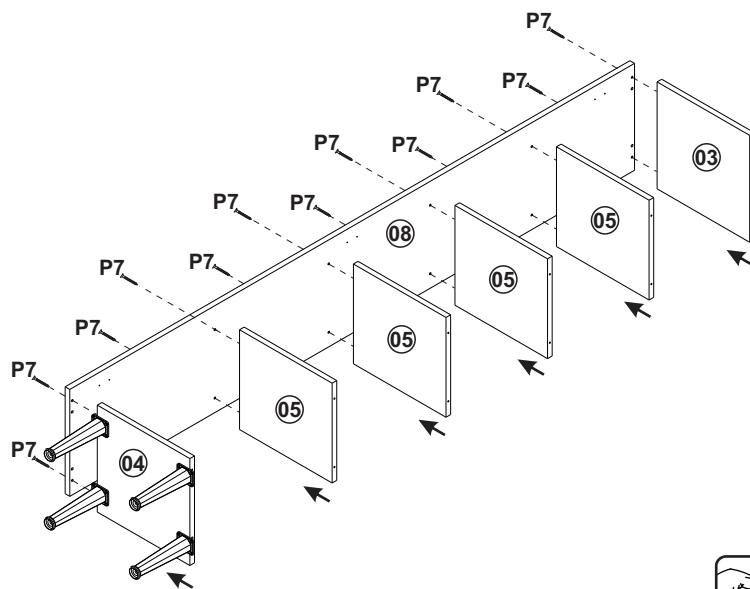

4°

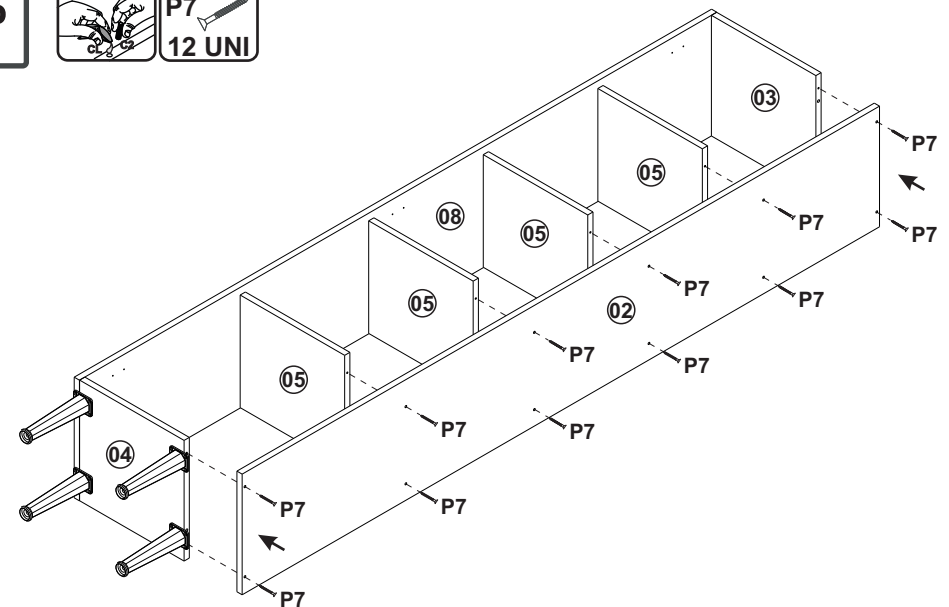

# CO6101 - PANELEIRO SIMPLES

Manual de Montagem  
 Assembly Instructions  
 Instrucción de Montaje



## 5° COSTA/REVÉS/BACK

- Pr1 55 UNI
- FX 03 UNI

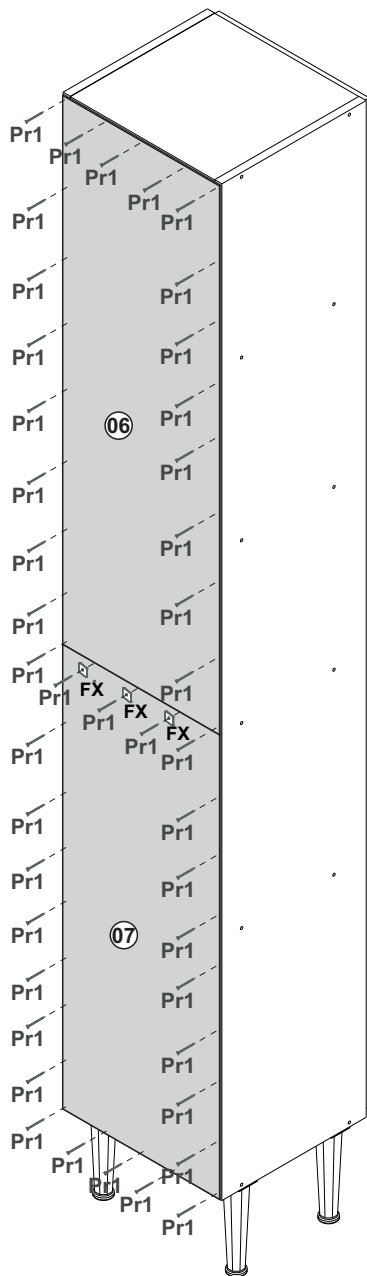

## 6°

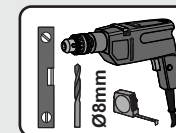
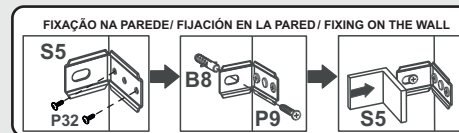

**!** PESO SUPORTADO.  
 PESO SUPORTADO.  
 WEIGHT SUPPORTED.

- P32 02 UNI

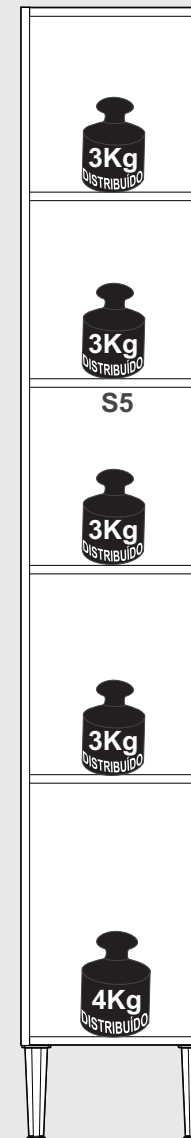

# CO6101 - PANELEIRO SIMPLES

Manual de Montagem  
Assembly Instructions  
Instrucción de Montaje

decibal®

7°

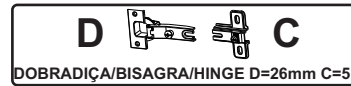

**P32**  
12 UNI

**P16**  
02 UNI

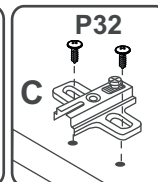
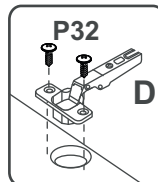
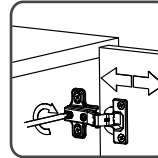
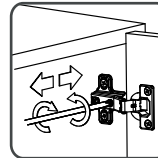
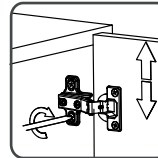
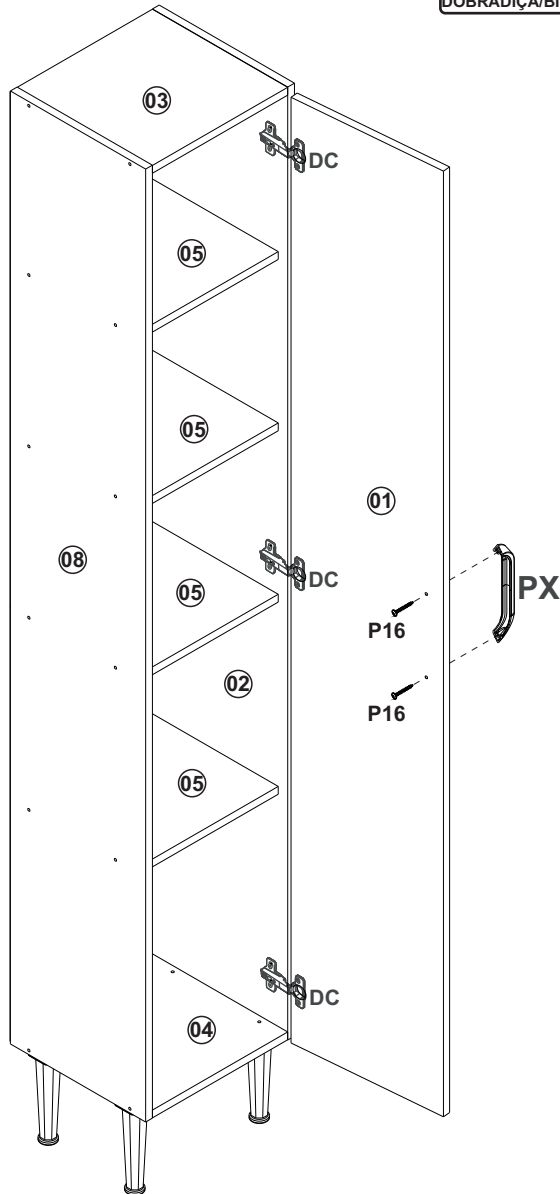

## Relação de Peças/ Relación de Piezas/Parts List

Nº	CÓDIGO/CODE	DESCRIÇÃO/DESCRIPCIÓN/DESCRIPTION	QTD/CANT	VOL.	
1	0570231	PORTA/PUERTA/DOOR	1816X312X15MM	1	1
2	0570227	LATERAL DIR/LATERAL/SIDE	1830X300X15MM	1	1
3	0570229	BASE SUP	300X300X15MM	1	1
4	0570234	BASE INF	300X300X15MM	1	1
5	0570230	PRATELEIRA MENOR/ESTANTE/SHELF	300X280X15MM	4	1
6	0570232	COSTA/REVÉS/BACK	988X326X2, 8MM	1	1
7	0570326	COSTA INF/REVÉS/BACK	836X326X2, 8MM	1	1
8	0570228	LATERAL ESQ/LATERAL/SIDE	1830X300X15MM	1	1

**ATENÇÃO!!!! montadores e consumidores**  
\* Ajustar o torque da parafusadeira para não danificar as peças escareando o parafuso \*

**ATENCIÓN!!!! montadores e consumidores**  
\* Ajuste el torque del destornillador para no dañar las piezas avallando el tornillo \*

**ATTENTION!!!! assemblers and consumers**  
\* Adjust the torque of the screwdriver so as not to damage the parts by countersinking the screw \*

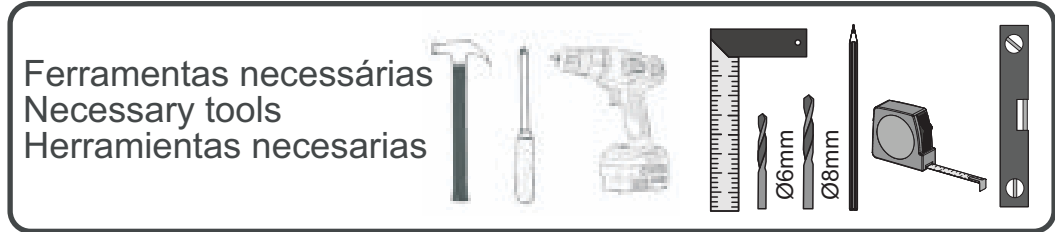

**ATENÇÃO!!!! montadores e consumidores**  
\* Para limpar o móveis utilize somente um pano úmido (umedecido em água pura ou água com sabão neutro). Depois, passe um pano seco. Evite a umidade excessiva.  
\* Evite usar álcool, água sanitária, detergente e outros produtos químicos, mesmo diluídos em água.  
\* Não utilize produtos abrasivos de nenhuma espécie

**ATENCIÓN!!!! montadores e consumidores**  
\* Para limpiar el mueble utilice solamente un paño húmedo (humedecido con agua limpia o con un jabón suave). A continuación, utilice un paño seco. Evite el exceso de humedad.  
\* Evite uso de alcohol, hipoclorido solución basada, detergente y otros productos químicos, mismo diluídos en agua. No utilice productos abrasivos de ningún tipo.







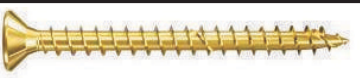

**ATTENTION!!!! assemblers and consumers**  
\* To clean the furniture, use only a damp cloth (humidify it only in pure water ou water and neutral soap). After, use a dry cloth. Avoid excessive humidity.  
\* Avoid using alcohol, bleach, detergent and other chemical products, even diluted in water. Do not use any kind of abrasive cleaning agents to clean the furniture. The use of such products may jeopardize the ?nal characteristics of the furniture.

# CO6101 - PANELEIRO SIMPLES







Manual de Montagem  
Assembly Instructions  
Instrucción de Montaje

decibal®

## Escala (1:1)

LEGENDA	DESCRIÇÃO/DESCRIPCIÓN/DESCRIPTION	CÓDIGO	QUANT.
<b>P7</b>	 PARAFUSO/TORNILLO/SCREW 4X45	01318	<b>24</b>
<b>P8</b>	 PARAFUSO/TORNILLO/SCREW 5X45	01320	<b>04</b>
<b>P9</b>	 PARAFUSO/TORNILLO/SCREW 6X50	03827	<b>01</b>
<b>P16</b>	 PARAFUSO/TORNILLO/SCREW 3.5X25	09955	<b>02</b>
<b>P32</b>	 PARAFUSO/TORNILLO/SCREW 4X14	12412	<b>14</b>
<b>PR1</b>	 PREGO/CLAVO/NAIL 10X10	01330	<b>55</b>
<b>C2</b>	 CAVILHA/TARUGO/DOWEL 6X30 MM	01211	<b>09</b>
<b>PU</b>	 PARAFUSO UNIÃO/UNIÓN DETORNILLO /SCREW UNION	01495	<b>02</b>

## Escala (N/A)

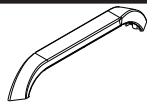
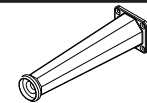
LEGENDA	DESCRIÇÃO/DESCRIPCIÓN/DESCRIPTION	CÓDIGO	QUANT.
<b>CL</b>	 COLA/PEGAMENTO/GLUE	01213	<b>01</b>
<b>ET</b>	 ETIQUETA LOGO DECIBAL/LABEL DECIBAL	01312	<b>01</b>
<b>B8</b>	 BUCHA/BUJE/BUCHING ( 8mm)	01311	<b>01</b>
<b>DC</b>	 DOBRADIÇA/BISAGRA/HINGE D=26mm C=5	01268	<b>03</b>
<b>S5</b>	 SUPORTE AÉREO/APOYO AÉREO/AIR SUPPORT	03828	<b>01</b>
<b>FX</b>	 FIXADOR COSTA/FIJADOR FONDO/FIXER COAST	01331	<b>03</b>
<b>AD</b>	ADESIVO/ADHESIVO/ADHESIVE 	15mm	<b>24</b>
<b>PX</b>	PUXADOR/PEGADOR /HANDLE DUBAI 160MM  CHAPAGNE ESCURO	13305	<b>01</b>
<b>PE</b>	PÉ/PATA/FOOT (170MM) BRONZE CAFE 	13306	<b>04</b>

www.decibal.com.br

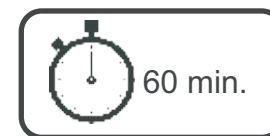

60 min.



1 montador  
1 ajustador  
1 Fitter

Medida em mm

