

DIMENSÕES DO PRODUTO / PRODUCT DIMENSIONS / DIMENSIONS PRODUCT - WxDxH / LxPxA - 1770 X 233X 2180 MM

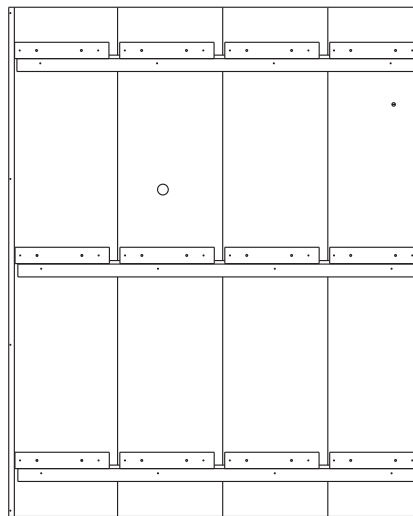

PEÇAS NUMERADAS / NUMBERED PARTS / PIEZAS NUMERADAS

EX: 1915X-X 04 (peça/ piece/ pieza number)

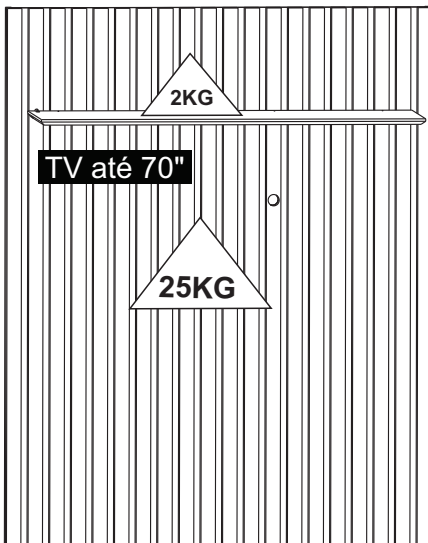
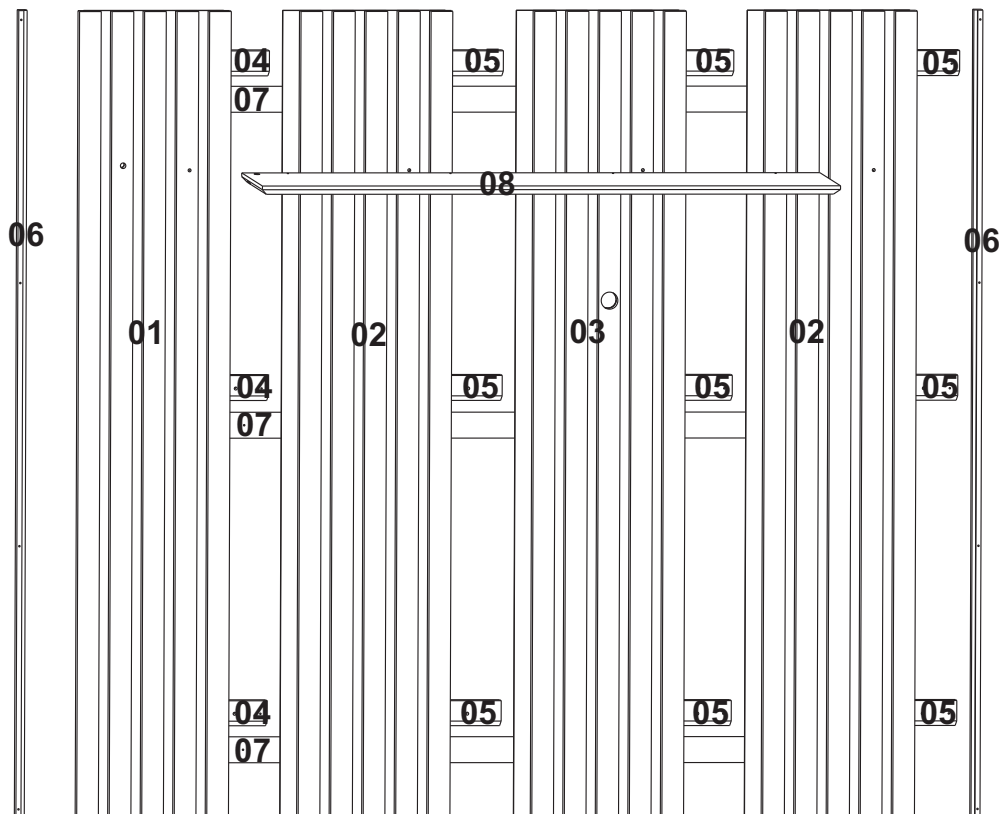

ATENÇÃO / ATTENTION / ATENCION

Nunca utilizar óleos, lustra móveis, produtos abrasivos, saponáceos, esponja de aço e outros.

Never use oils, furniture polish, abrasive products, soaps, steel sponge and others.

Nunca use aceites, pulimentos, abrasivos, jabones, esponja de acero y otros.

CUIDADOS ESPECIAIS/ SPECIAL CARE/ CUIDADOS ESPECIALES

- Evitar expor o móvel ao sol, e em lugares úmidos.
- Limpar com flanela seca ou com pano levemente umedecido em água.
- Avoid exposing the furniture to the sun, and in damp places.
- Clean with dry flannel or lightly cloth moistened with water.
- Evite exponer los muebles al sol y en lugares húmedos.
- Limpiar con flanela seca o un paño ligero, humedecido con agua.

Ferramentas necessárias (não fornecidas) Necessary tools (not provided) Herramientas Necesarias (No proporcionadas)

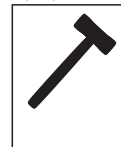

MONTAR O PRODUTO SOBRE A EMBALAGEM, EVITANDO DANOS NA PINTURA. ACONSELHAMOS QUE A MONTAGEM DO PRODUTO SEJA POR UM PROFISSIONAL.

SETUP THE PRODUCT ON TOP OF THE PACKAGING, AVOIDING DAMAGE TO THE PAINT. WE RECOMMEND THAT THE INSTALLATION IS DONE BY A PROFESSIONAL.

MONTAR EL PRODUCTO EN EL PAQUETE, EVITAR LESIONES EN PINTURA. AVISAMOS QUE EL MONTAJE DEL PRODUCTO SEA UN PROFESIONAL.

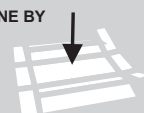

MEDIDA UTILIZADA EM MM/ UNIT MEASURE USED IS MILLIMETERS (MM)

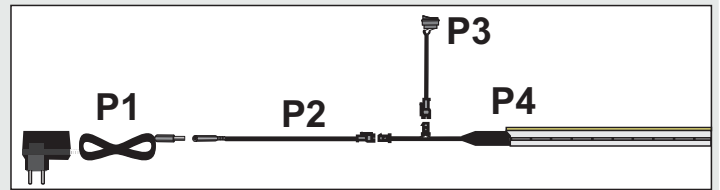
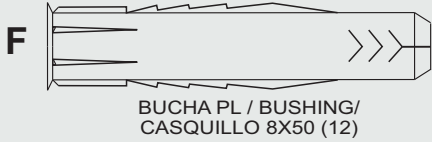
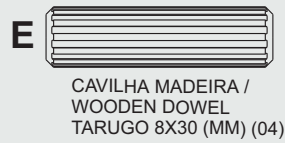
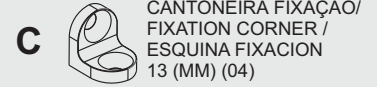

ITEM		DESCRIÇÃO DA PEÇAS / DESCRIPTION OF PARTS / UNIT MEASURE USED IS MILLIMETERS (MM)				CORES DO PRODUTO/ COLORS PRODUCT/ COLORES PRODUCTO	
COD	Nº	NOME/NAME/NOMBRE	MEDIDAS / MEASURES (MM)	TIPO TYPE	QUANT AMOUNT CANTIDAD	CEDRO AC (CÓD- 03)	OFF WHITE BEGE AC (CÓD- 06)
19193	1	PAINEL RIPADO 01 / PANEL 01/ PAINEL 01	2180X420X18	MDF	1	01/03	01/06
19194	2	PAINEL RIPADO 02/ PANEL 02/ PAINEL 02	2180X466X18	MDF	2	02/03	02/06
19452	3	PAINEL RIPADO 03/ PANEL 3/ PAINEL 03	2180X466X18	MDF	1	03/03	03/06
19189	4	RÉGUA FIXA MENOR / FIXED RULER / REGLA FIJA	365X70X15	MDF	3		
19453	5	RÉGUA FIXA MAIOR/ FIXED RULER / REGLA FIJA	404X70X15	MDF	9		
19190	6	VISTA LATERAL / VIEW SIDE/ VISTA LADO	2180X24X15	MDF	2	06/03	06/06
19191	7	RÉGUA PAREDE SUP-INF./BOTTOM AND TOP WALL RULER/ REGLA DE PARED INFEIOR Y SUPERIOR	1700X70X15	MDF	3		
19192	8	PRATELEIRA / SHELF/ ESTANTE	1600X200X25	MDF	1	08/03	08/06
8	A	PF./ Screw/ Tornillo 4,8X75 (MM) CH			12		
434	B	PF./ Screw/ Tornillo 4,0x25 (MM) CH			40		
11136	C	Cantoneira/ Fixation Corner/ Esquina Fixacion 13x13 (MM)			04		
2921	D	Cavilha / Wooden Dowel / Tarugo 8x20 (MM)			24		
137	E	Cavilha / Wooden Dowel / Tarugo 8x30 (MM)			04		
2922	F	Bucha Pl/ Bushing/ Casquillo 8X50 (MM)			12	Cinza	Cinza
7136	G	Passa Fio/ Wire Support/ Hilo 46 (MM)			01	Café	
8456							Branco
19332	P	KIT FITA LED LM 2105 INCOLOR NEON 3000 K IP65- 1525 (MM)			01		
		Certif. de Garant./ Warranty Certif.			01		

PREPARAÇÃO DE PEÇAS/ PARTS PREPARATION/ PREPARACION DE PIEZAS

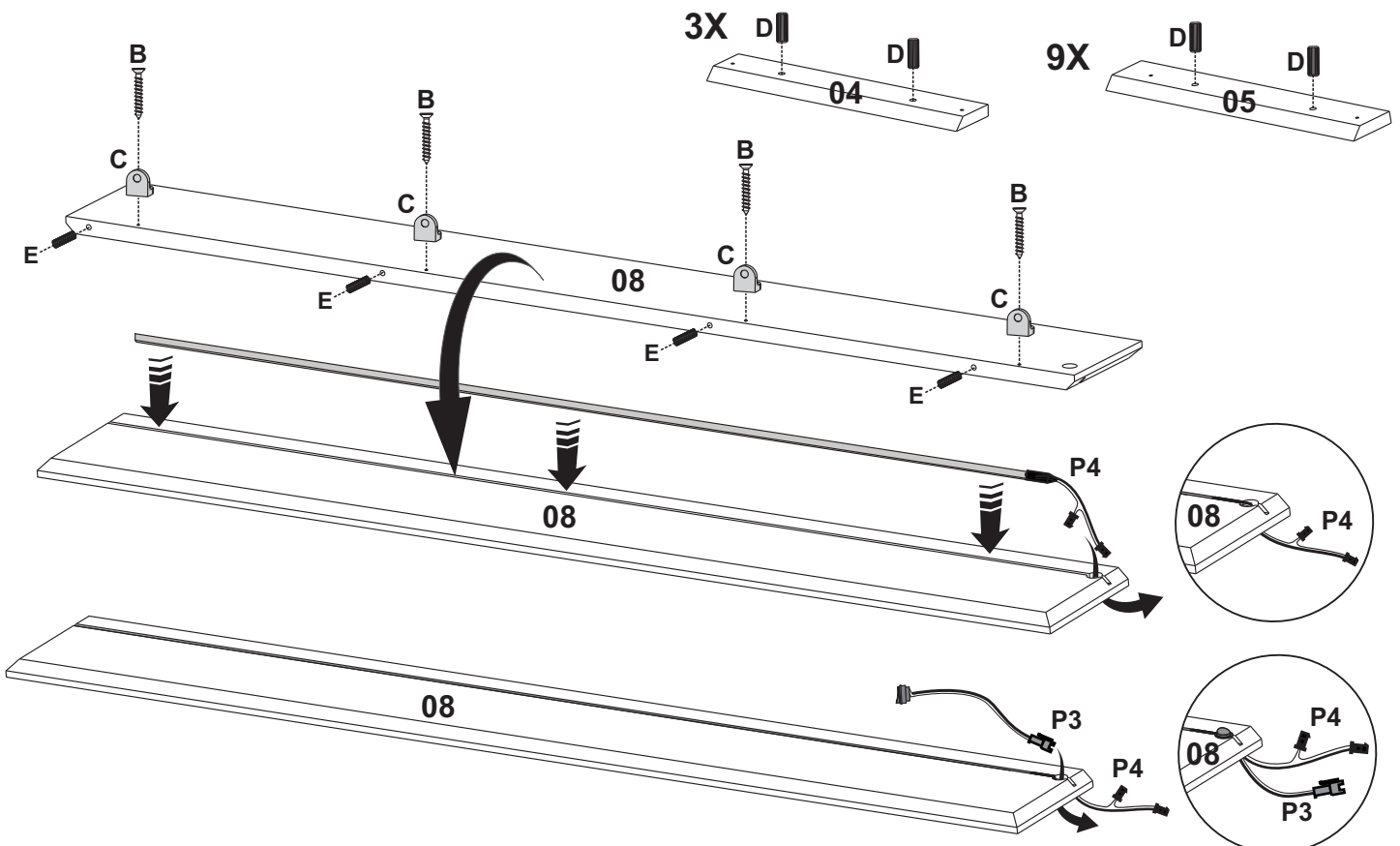

1

Obs: As peças pintadas nos passos são apenas ilustrativas. The parts painted in the steps are illustrative only. Las partes pintadas en los pasos son solo ilustrativas.

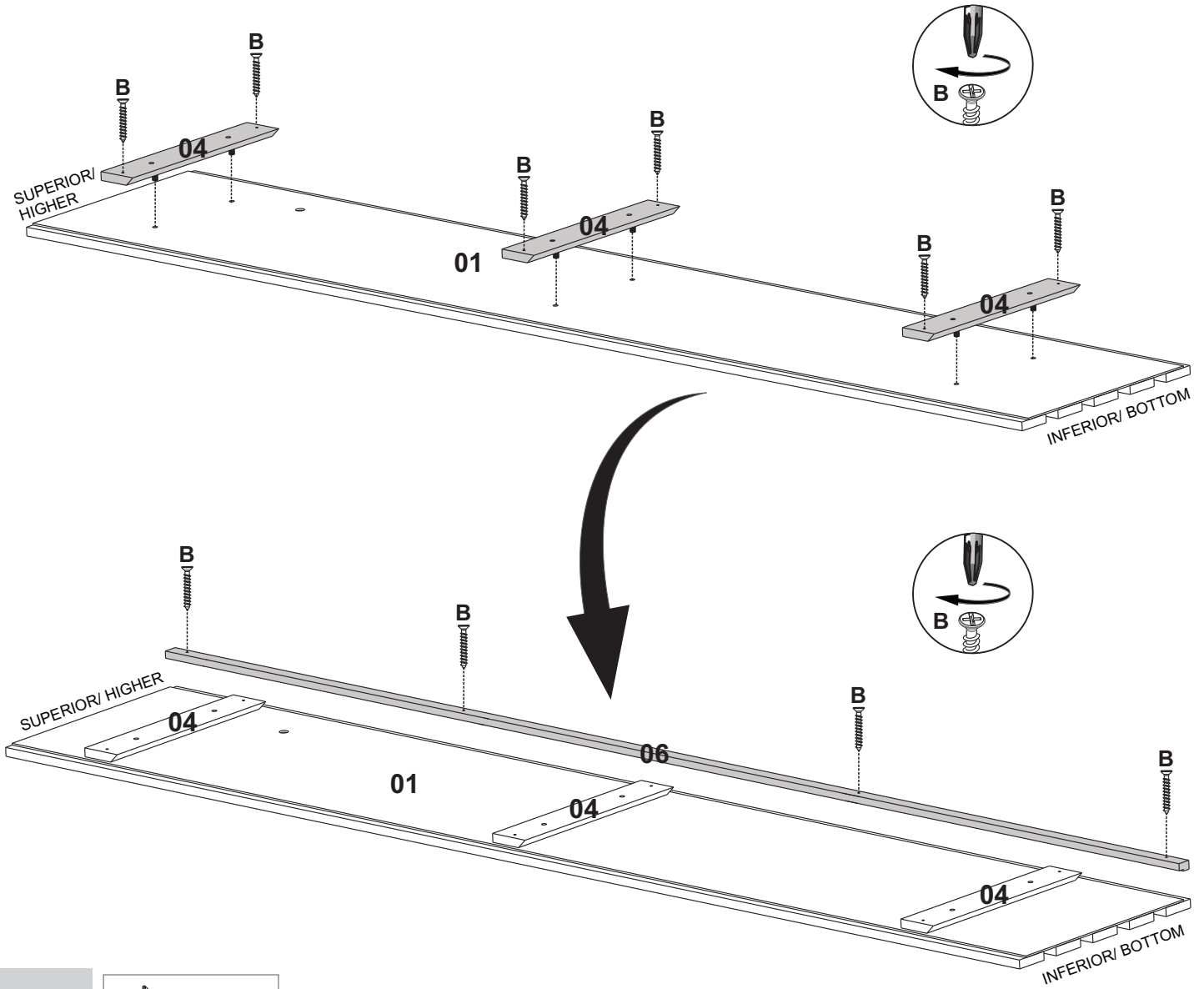

B=10

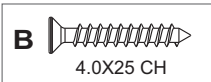

2

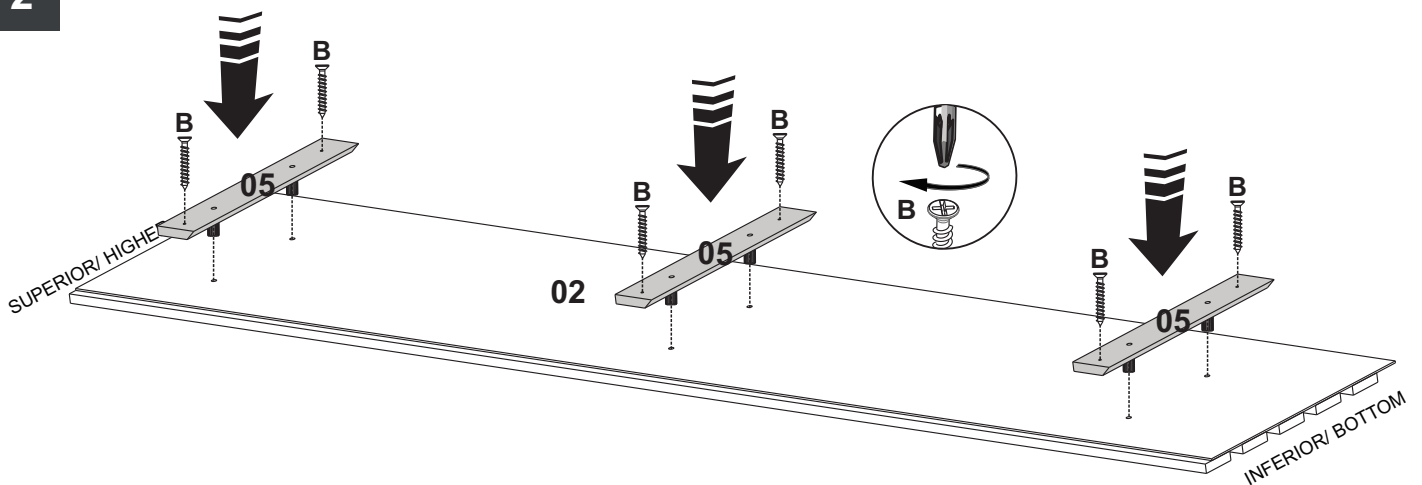

B=06

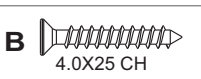

3

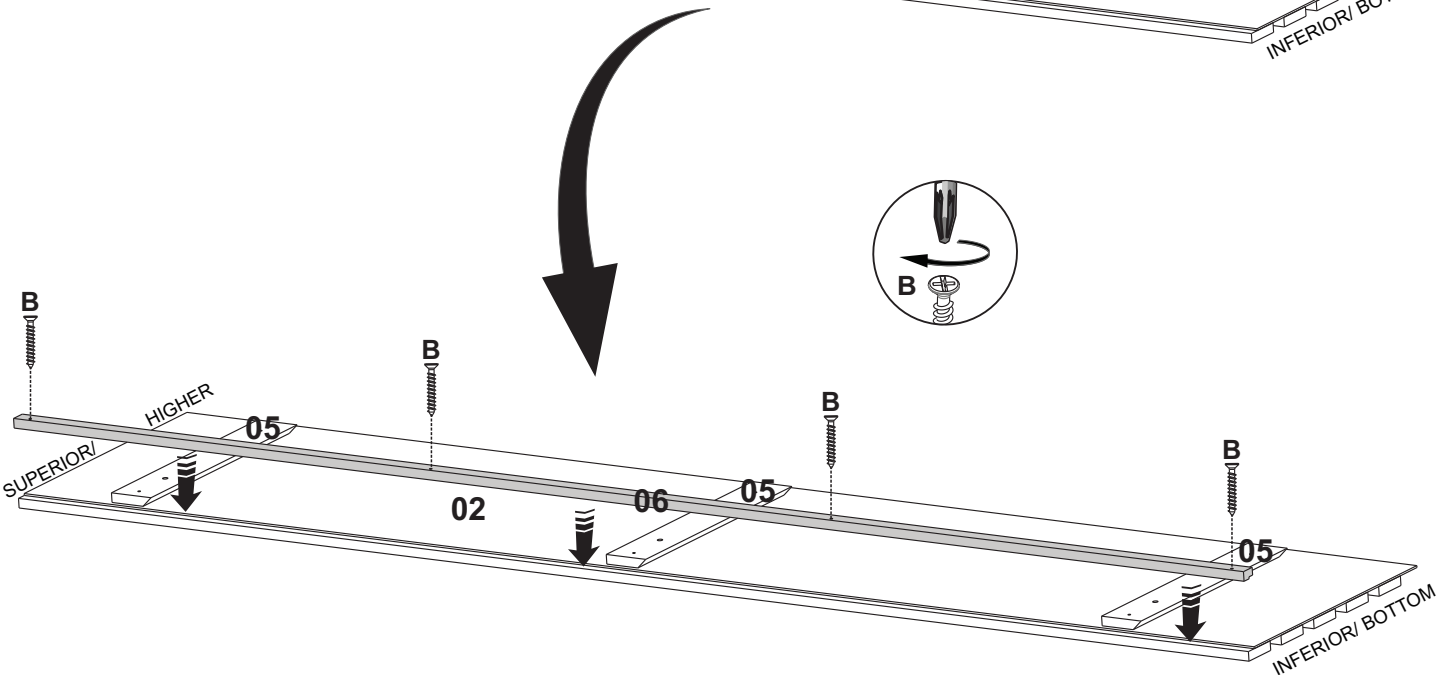
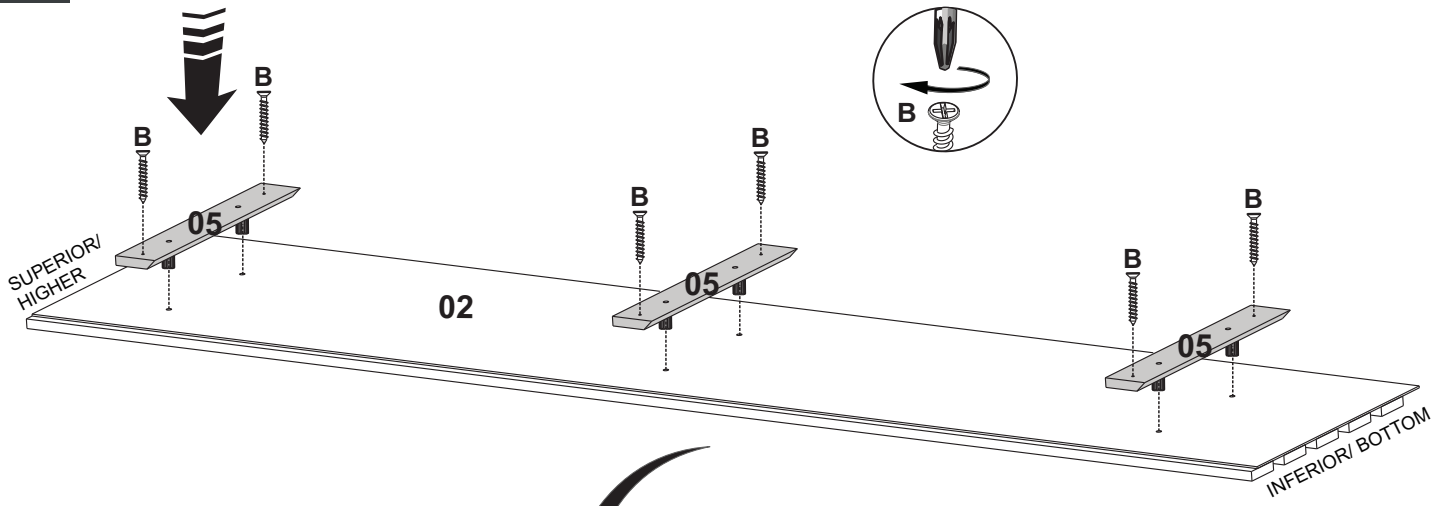

B=10

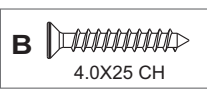

4

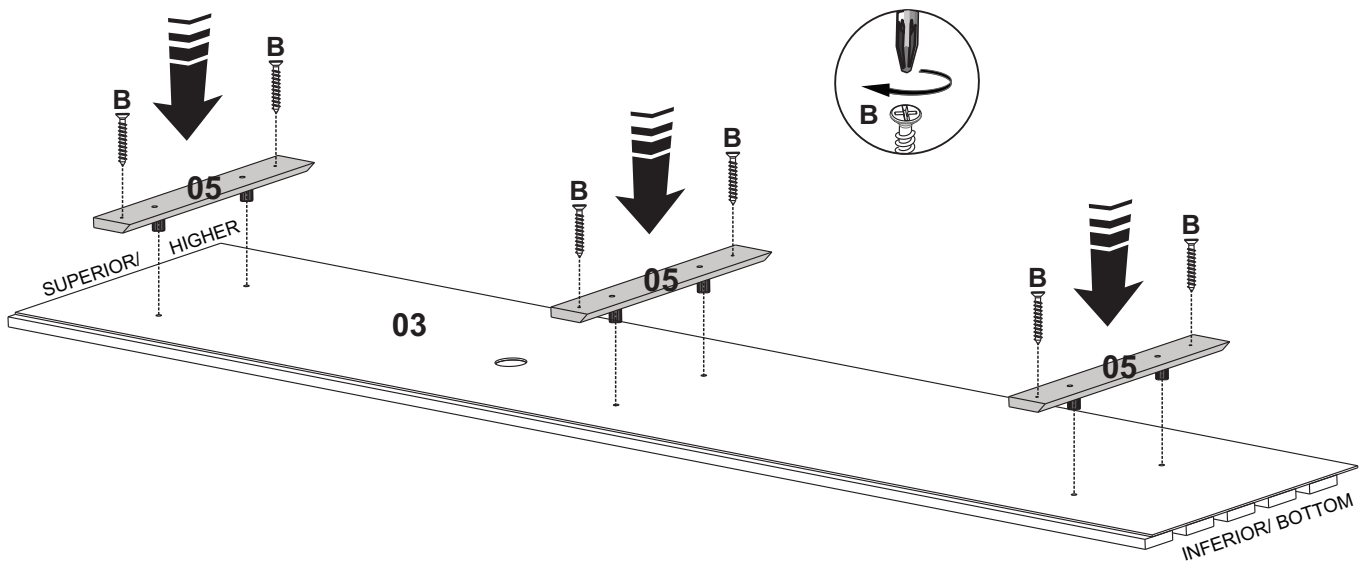

B=06

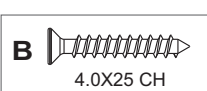



ATENÇÃO PARA A INSTALAÇÃO DAS RÉGUAS/
ATTENTION WHEN INSTALLING THE WALL RULES /
ATENCIÓN AL INSTALAR LAS REGLAS DE PARED

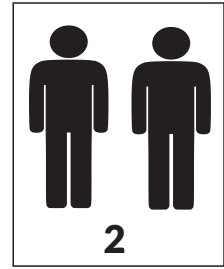

PERFIL/
PROFILE

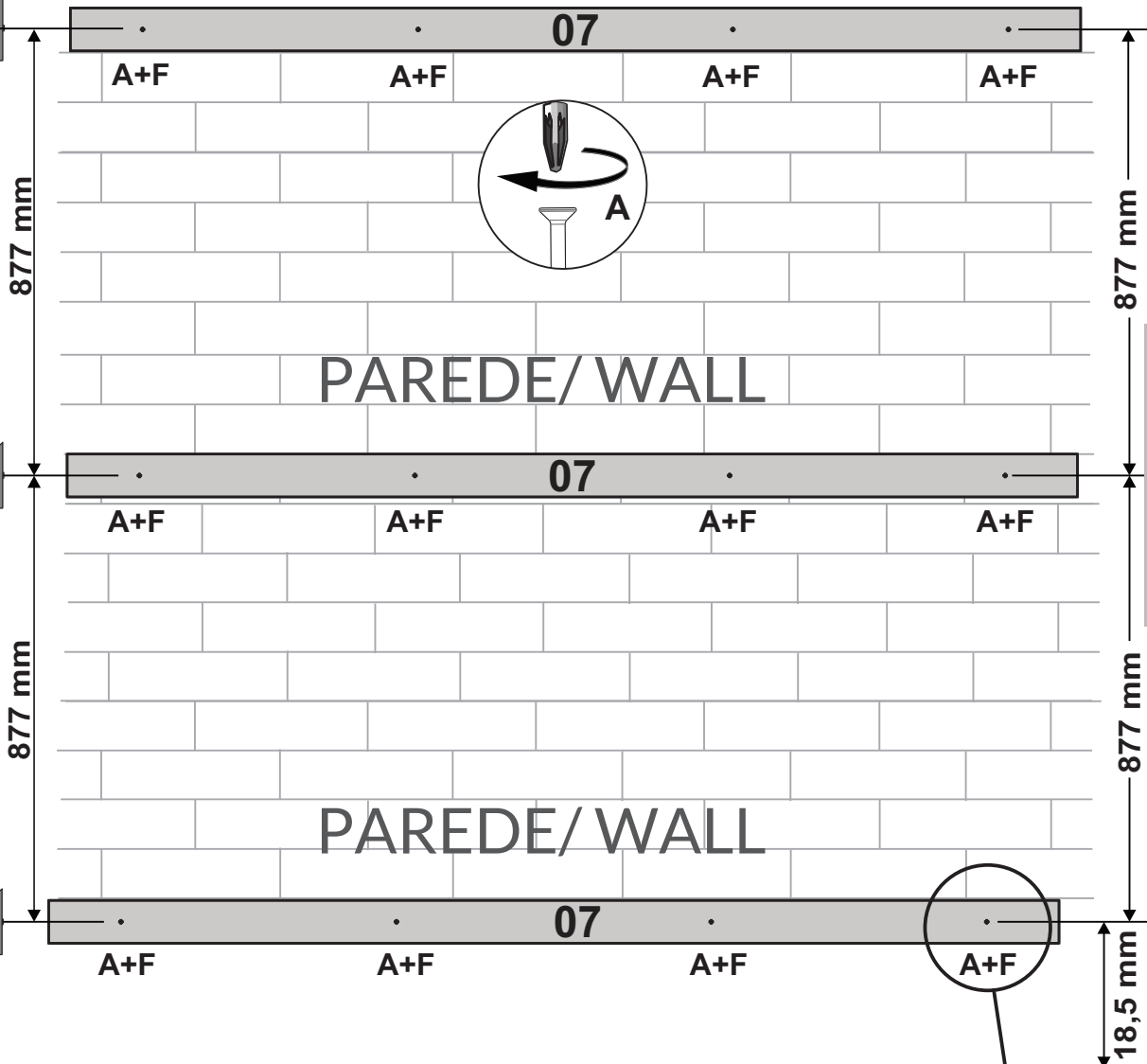

ENTRE FUROS/
BETTER HOLES/
ENTRE AGUJEROS



A=12
F=12

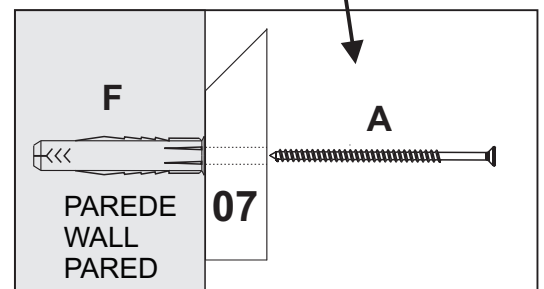
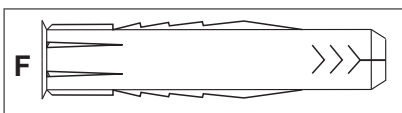
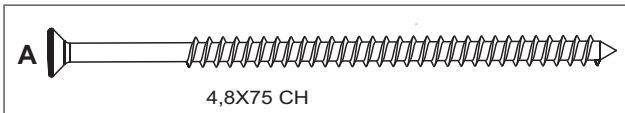

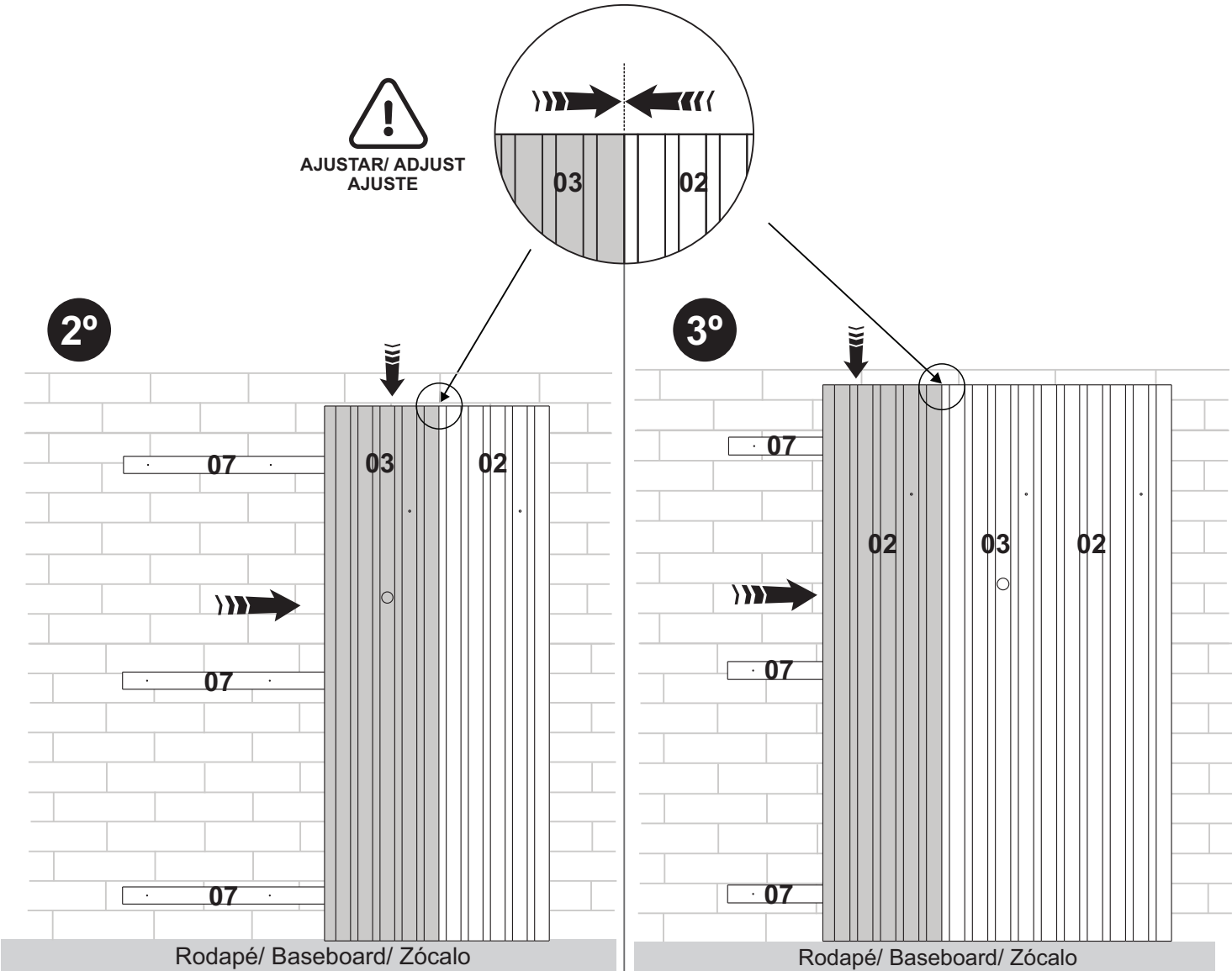
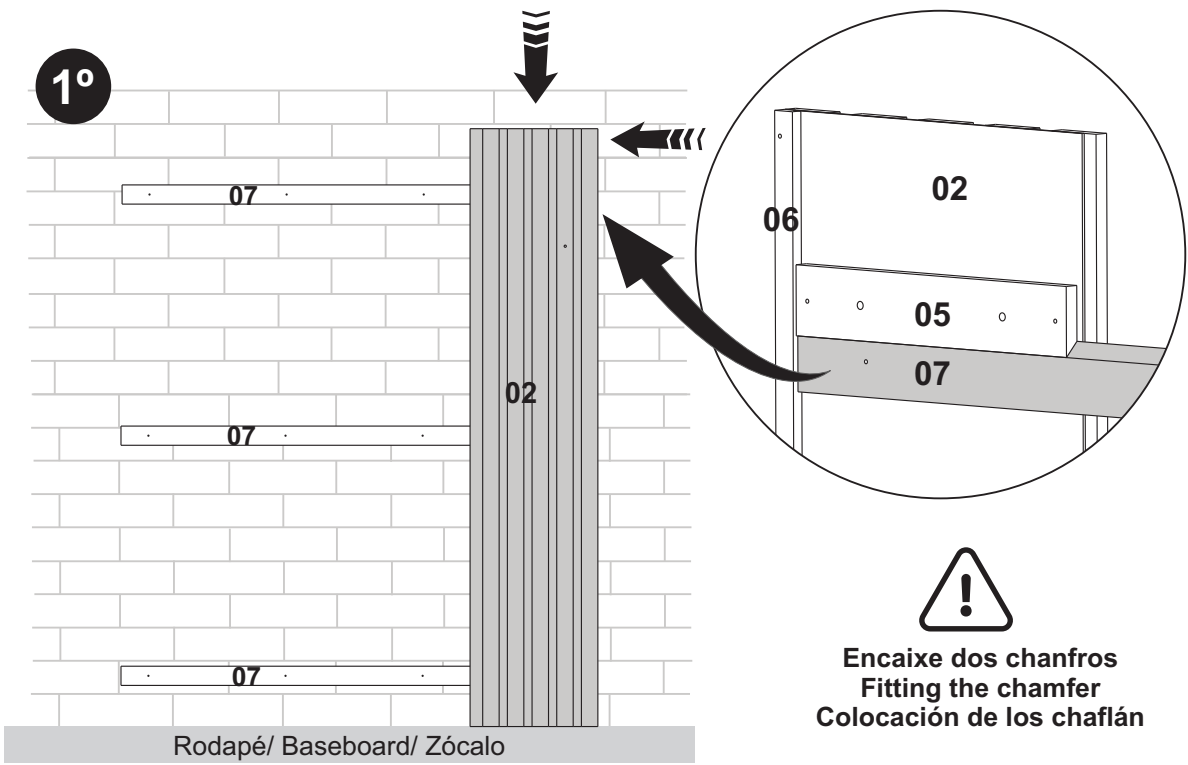



ATENÇÃO PARA A INSTALAÇÃO DO LED/
ATTENTION FOR LED INSTALLATION/
ATENCIÓN PARA LA INSTALACIÓN LED

MANUAL DE MONTAGEM/ ASSEMBLY MANUAL/
MANUAL DE MONTAJE

IMPORTANTE/ IMPORTANT/ IMPORTANTE

DESLIGAR A CHAVE GERAL DA
REDE ELETRICA LUMINÁRIA BIVOLT
APAGAR EL INTERRUPTOR PRINCIPAL
DE LA RED ELÉCTRICA LUZ BIVOT/
TURN OFF THE MAINS SWITCH FROM THE
ELECTRICAL NETWORK BIVOLT LIGHT/



P1

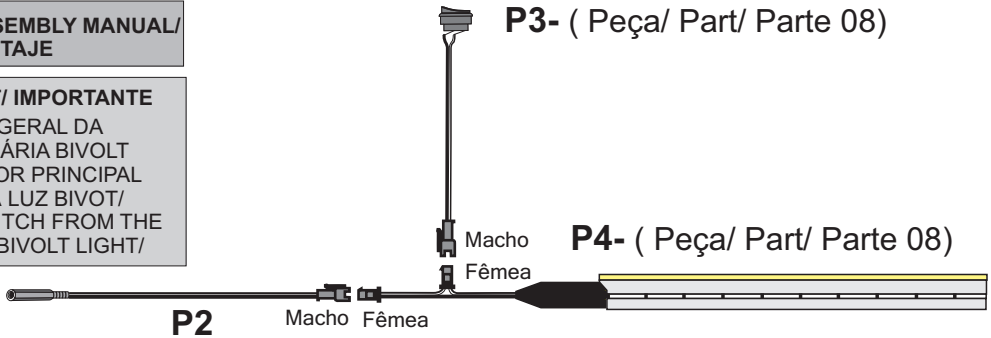

P3- (Peça/ Part/ Parte 08)

P4- (Peça/ Part/ Parte 08)

Siga o manual

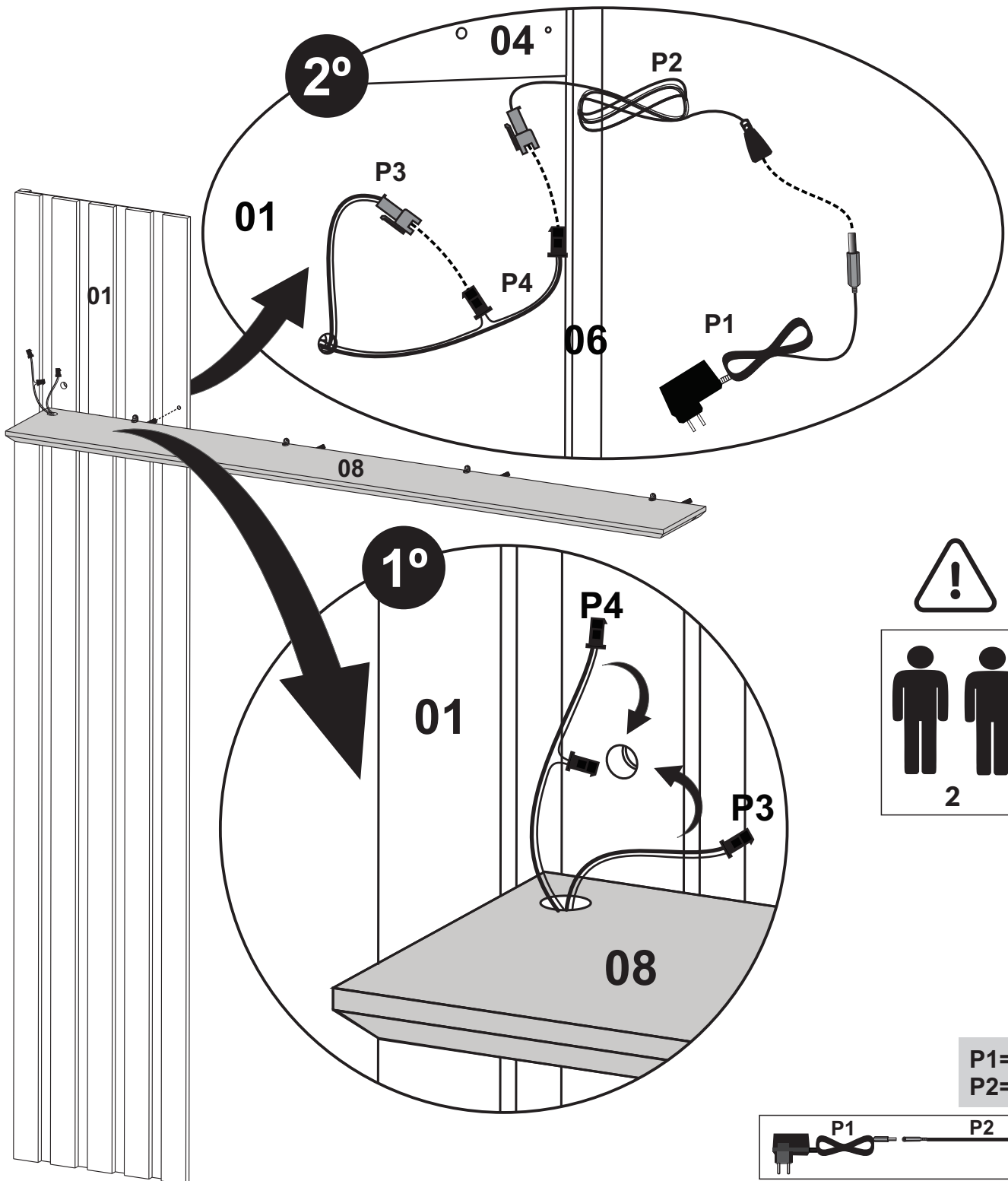

P1=01
P2=01



8

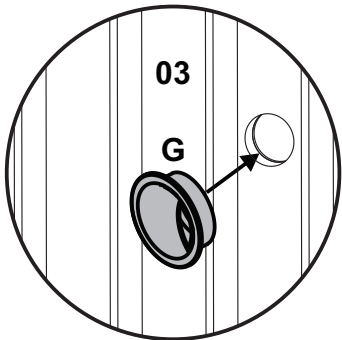
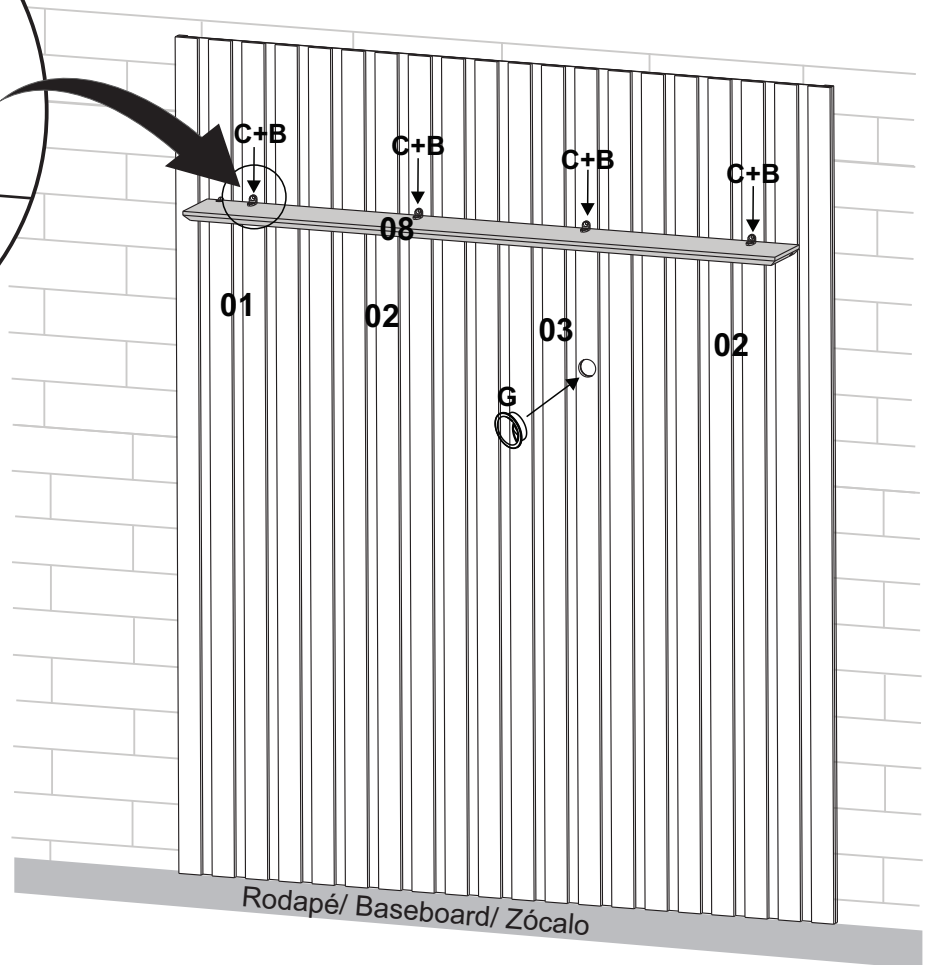
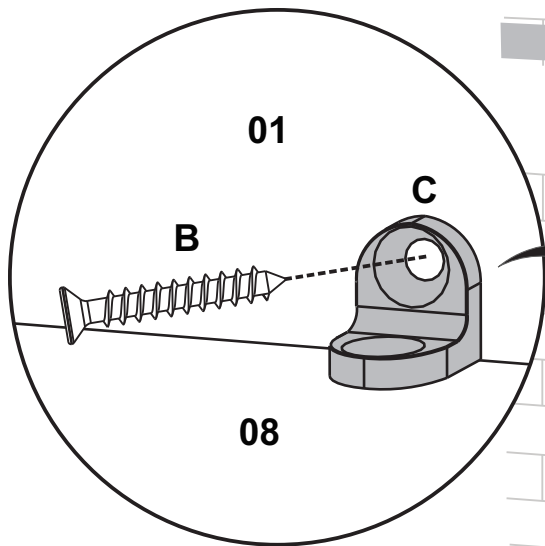
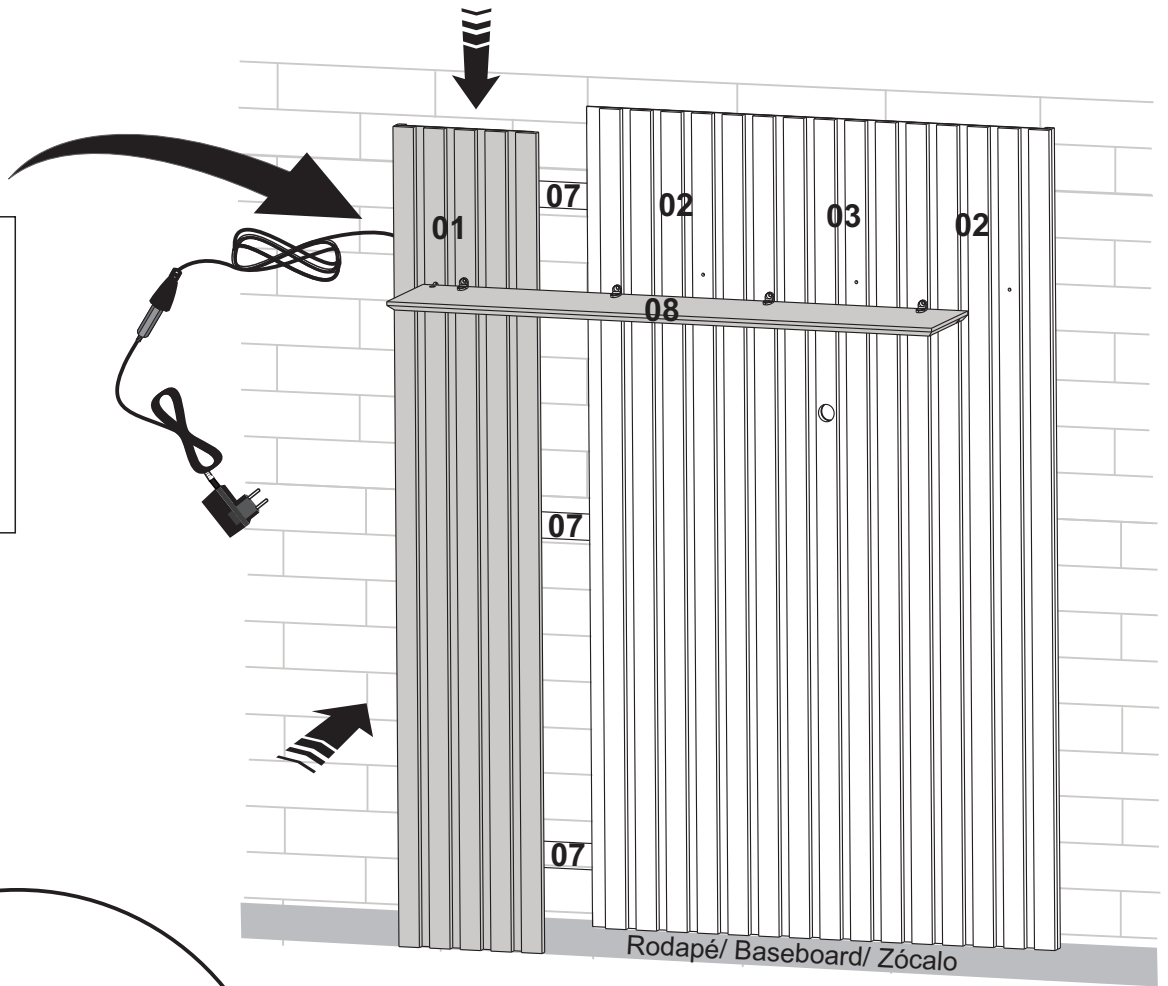
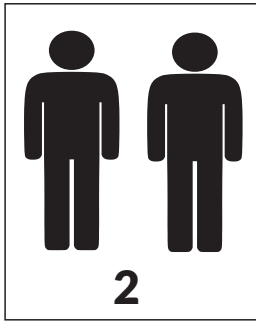

B=04
G=01

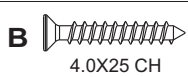

NOTA / NOTE Não nos responsabilizamos por acidentes, se a instalação do móvel não estiver com os procedimentos deste Manual e não for realizado por pessoa habilitada.
We are not responsible for accidents if the installation of the furniture is not in accordance with the procedures in this Manual and is not carried out by a qualified person.
No nos hacemos responsables de accidentes si la instalación de los muebles no se realiza de acuerdo con los procedimientos de este Manual y no es realizada por una persona calificada.