

INSTRUÇÕES DE MONTAGEM

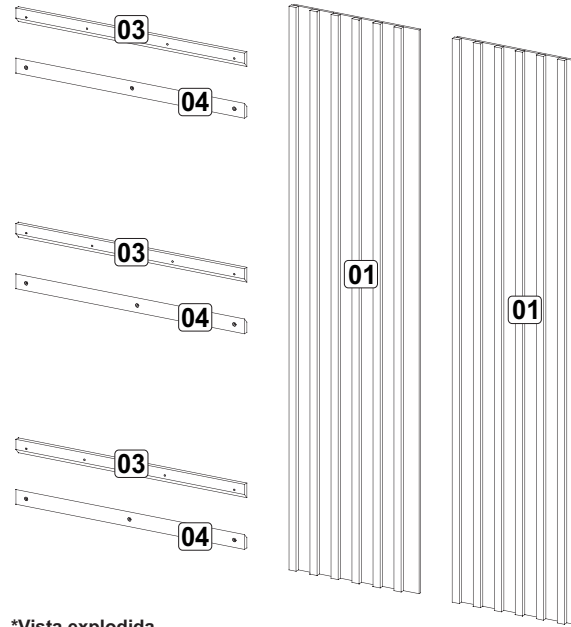

*Vista explodida

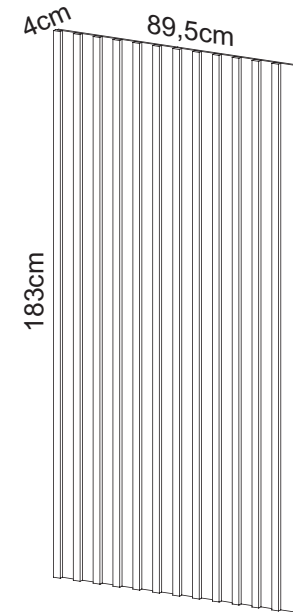

*Produto montado





LISTA DE PEÇAS / PARTS LIST / LISTA DE PIEZAS

01 - Painel 2x - 1830 x 450 x 24mm
 03 - Suporte 3x - 805 x 48 x 15mm
 04 - Suporte Parede 3x - 805 x 48 x 15mm

01 - Panel
 03 - Support
 04 - Wall Support

01 - Panel
 03 - Soporte
 04 - Soporte Pared

FERRAGENS / HARDWARE / MATERIALES

A		3,5 x 9,5	04
B		4,5 x 25	12
C		5,5 x 55	09
D	Para alvenaria To masonry work Para albañilería 	Ø8	09
E			02

Pré Montagem

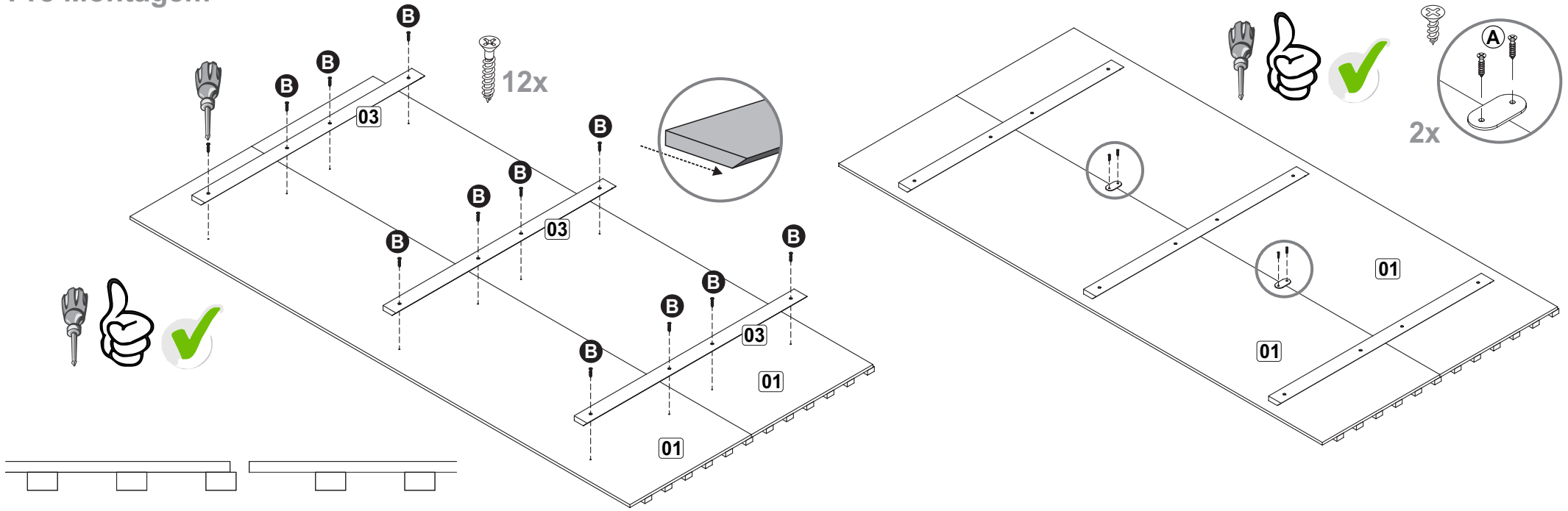

01

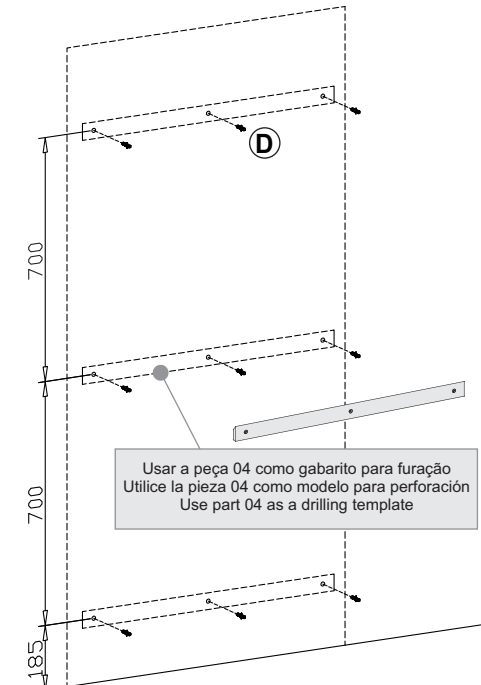

02

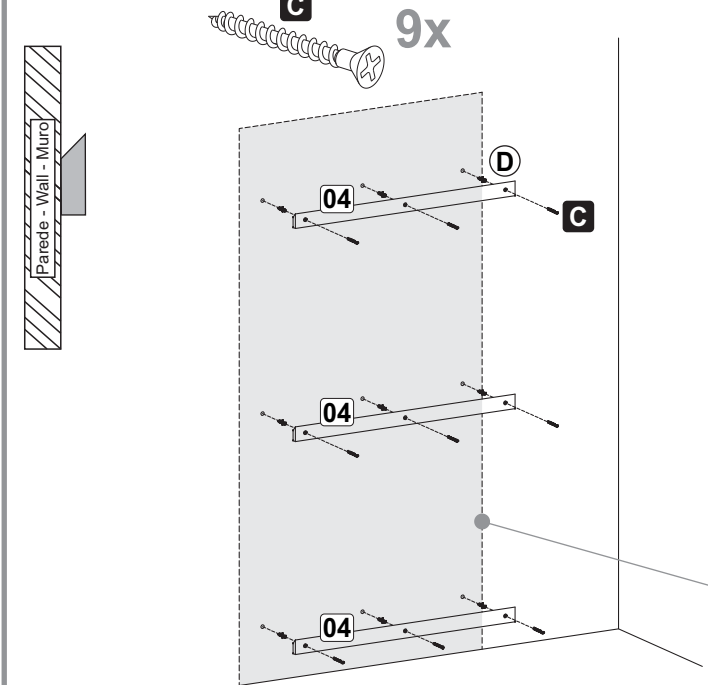

03

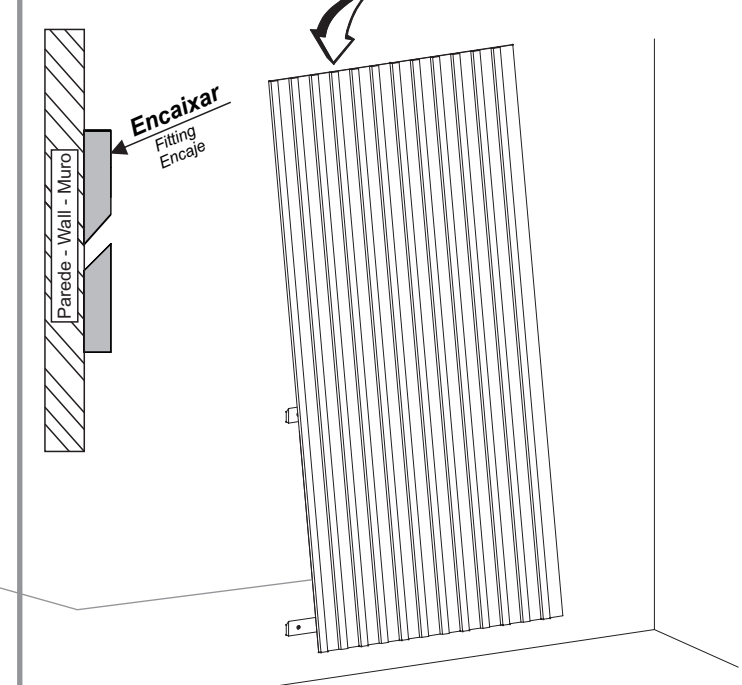

INSTRUÇÕES DE MONTAGEM

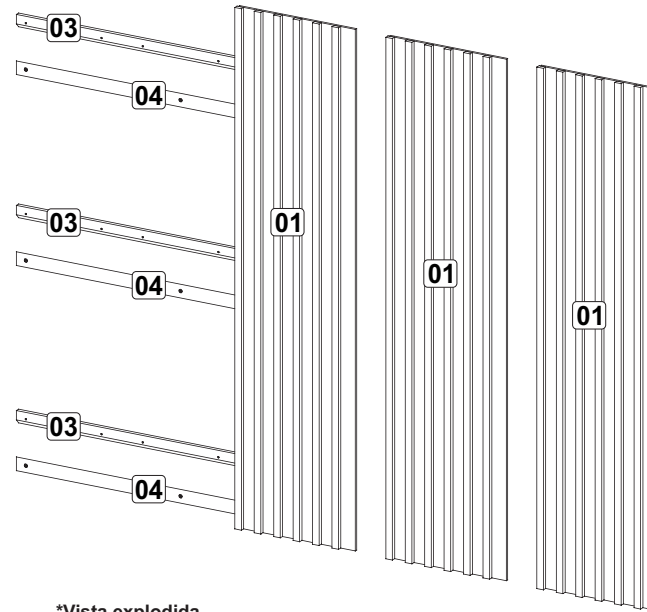

*Vista explodida

LISTA DE PEÇAS / PARTS LIST / LISTA DE PIEZAS

01 - Painel 3x - 1830 x 450 x 24mm
 03 - Suporte 3x - 1250 x 48 x 15mm
 04 - Suporte Parede 3x - 1250 x 48 x 15mm

01 - Panel
 03 - Support
 04 - Wall Support



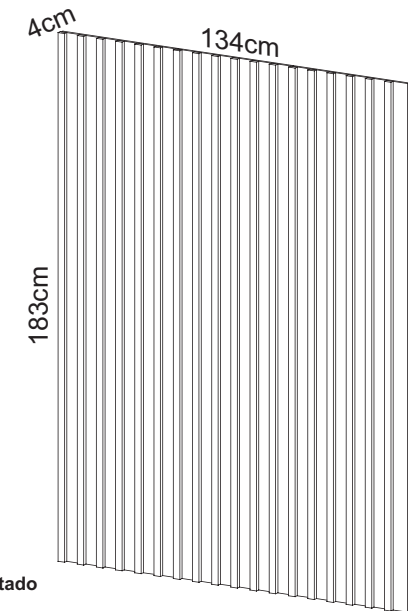

01 - Panel
 03 - Soporte
 04 - Soporte Pared

PA73

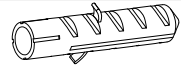

*Produto montado

FERRAGENS / HARDWARE / MATERIALES

A		3,5 x 9,5	08
B		4,5 x 25	18
C		5,5 x 55	09
D	Para alvenaria To masonry work Para albañilería 	Ø8	09
E			04

Pré Montagem

