



**ESCRIVANINHA
SMILE**

ATENÇÃO / ATTENTION / ATENCION

VÍDEO DE MONTAGEM DISPONÍVEL NO SITE / ASSEMBLY VIDEO AVAILABLE ON THE SITE / VÍDEO DE MONTAJE DISPONIBLE EN EL SITIO

www.olivar.com.br

DIMENSÕES DO PRODUTO / PRODUCT DIMENSIONS / DIMENSIONS PRODUCT - WxDxH / LxDxA - 680 X 385X 765 MM

MEDIDA UTILIZADA EM MM / UNIT MEASURE USED IS MILLIMETERS (MM)

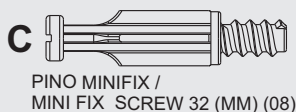
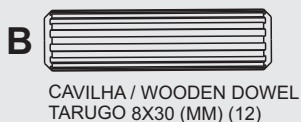

TAMBOR MINIFIX / MINI FIX ROUND NUT 15 (MM) (08)



TAPA FURO / MINI FIX COVER CAP(04)



TAPA FURO /HOLE COVER/
TAPA AGUGERO 8 (MM) (04)



RODÍZIOS/ WHEELS/
RUEDAS (04)

PEÇAS NUMERADAS/ NUMBERED PARTS/
PIEZAS NUMERADAS

EX: 1915X-X 05(peça/ piece/ pieza number)

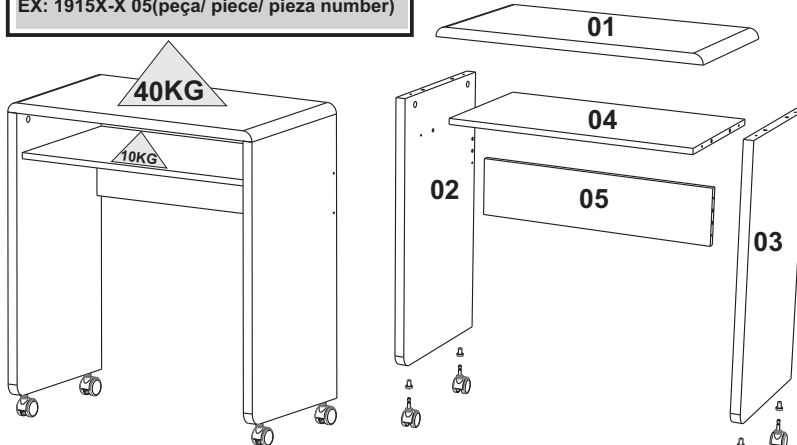

FIXAR PINO DE MINIFIX, TAMBOR E TAMPA / FIXING THE MINIFIX PIN,
DRUM AND MINIFIX COVER / COLOQUE EL PINO E TAMBOR MINIFIX Y LA TAMPA

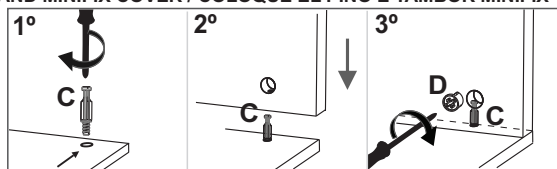

Vídeo de Montagem
Assembly video
Vídeo de Montaje

ITEM		DESCRIÇÃO DA PEÇAS / DESCRIPTION OF PARTS / UNIT MEASURE USED IS MILLIMETERS (MM)				CORES/ COLORS/ COLORES	
CÓDIGO CODE	Nº	NOME/NAME/NOMBRE	MEDIDAS / MEASURES (MM)	TIPO TYPE	QUANT AMOUNT CANTIDAD	BRANCO WHITE BLANCO	PTO BLACK NEGRO
8098	1	TAMPO/ TOP	680X385X25	MDF	1	1/5	1/7
8099	2	LAT. ESQUERDA/ LEFT SIDE/ LADO IZQUIERDO	690X385X25	MDF	1	2/5	2/7
8100	3	LAT. DIREITA/ RIGHT SIDE/ LADO DERECHO	690X385X25	MDF	1	3/5	3/7
8101	4	PRATELEIRA/ SHELF/ ESTANTE	630X360X15	MDP	1	4/5	4/7
8102	5	REFORÇO/ REINFORCEMENT/ REFUREZO	630X150X15	MDP	1	5/5	5/7
438	A	PF. / Screw / Tornillo 4,0x40(MM) CH			04		
137	B	Cavilha / Wooden Dowel / Tarugo 8x30(MM)			12		
532	C	Pino Minifix / Minifix Screw 32(MM)			08		
508	D	Tambor Minifix / Minifix Round Nut 15(MM)			08		
252	E	Tampa Minifix / Minifix Cover Cap 15(MM)fix 15 MM			04	BCO	PTO
254	F				04	BCO	PTO
8108	G	Rodízios PL/ Wheels/ Ruedas 40x40x40 MM			04	BCO	PTO
		Certificado Garantia/ Warranty Certif.			01		

CUIDADOS ESPECIAIS

LIMPEZA- Pano limpo umedecido em água e sabão neutro.
BRILHO- Flanela seca.

SPECIAL CARE

CLEANING-Clean cloth moistened with water and mild soap.
SHINE- Dry cloth.

CUIDADOS ESPECIALES:

LIMPIEZA- Paño limpio humedecido con agua y un jabón suave.
BRIGHT- Franela seca.

ATENÇÃO / ATTENTION / ATENCION

Nunca utilizar óleos, lustra móveis; produtos abrasivos, saponáceos, esponja de aço e outros.

Never use oils, polish furniture , abrasive products, soaps, steel sponge and others.

Nunca use aceites, pulimentos; abrasivos, jabones, esponja de acero y otros.

Ferramentas necessárias / Necessary tools / Herramientas Necesarias
(não fornecidas) (not provided) (No proporcionadas)



MONTAR O PRODUTO SOBRE A EMBALAGEM,
EVITANDO DANOS NA PINTURA.
ACONSELHAMOS QUE A MONTAGEM DO PRODUTO
SEJA POR UM PROFISSIONAL.

SETUP THE PRODUCT ON TOP OF THE PACKAGING,
AVOIDING DAMAGE TO THE PAINT.
WE RECOMMEND THAT THE INSTALLATION IS DONE BY
A PROFESSIONAL.

MONTAR EL PRODUCTO EN EL PAQUETE,
EVITAR LESIONES EN PINTURA.
AVISAMOS QUE EL MONTAJE DEL PRODUCTO
SEA UN PROFESIONAL.



1

Obs: As peças pintadas nos passos são apenas ilustrativas.
The parts painted in the steps are illustrative only.
Las partes pintadas en los pasos son solo ilustrativas.

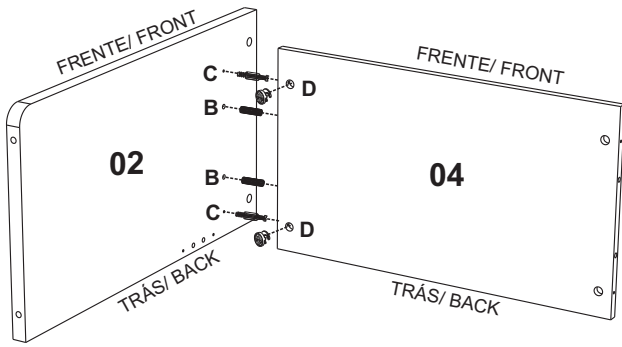
2

B=02
C=02
D=02

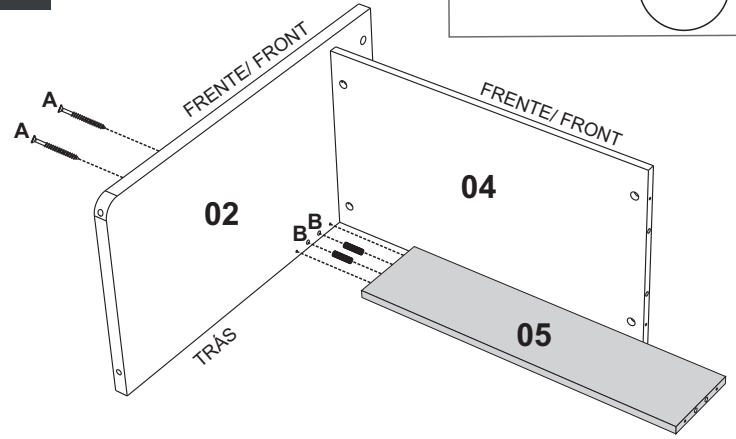
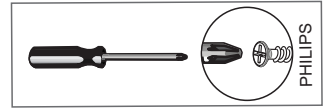
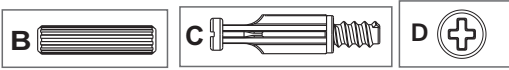

A=02
B=02

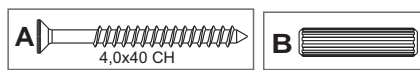
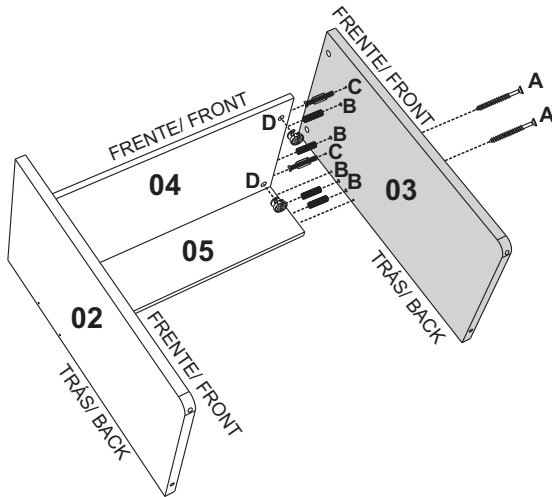
**3**

A=02
B=04
C=02
D=02

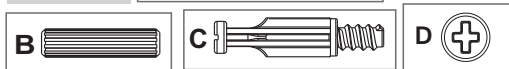
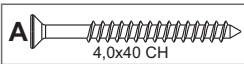
**4**

Encaixar os rodízios e bater com martelo/
Fit the wheels and hit with hammer/
Monta las ruedas y golpe con martillo.

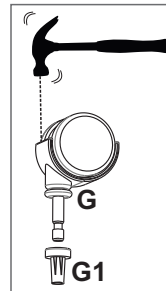
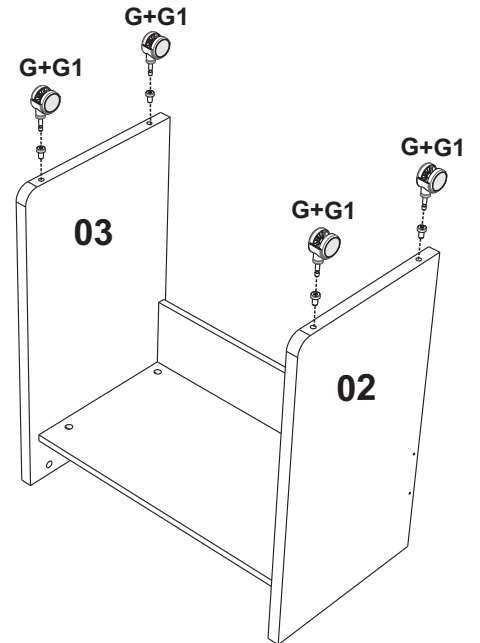
**G=04****5**

B=04
C=04
D=04
E=04
F=04

