

# ATENÇÃO / ATTENTION / ATENCION

VÍDEO DE MONTAGEM DISPONÍVEL NO SITE / ASSEMBLY VIDEO AVAILABLE ON THE SITE / VÍDEO DE MONTAJE DISPONIBLE EN EL SITIO

DIMENSÕES DO PRODUTO / PRODUCT DIMENSIONS / DIMENSIONS PRODUCT - WxDxH / LxDxA - 680 X 385X 765 MM

MEDIDA UTILIZADA EM MM / UNIT MEASURE USED IS MILLIMETERS (MM)

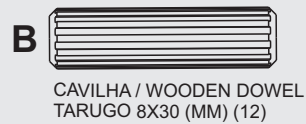

TAMBOR MINIFIX / MINI FIX ROUND NUT 15 (MM) (08)



TAPA FURO / MINI FIX COVER CAP(04)



TAPA FURO /HOLE COVER/  
TAPA AGUGERO 8 (MM) (04)



RODÍZIOS/ WHEELS/  
RUEDAS (04)

PEÇAS NUMERADAS/ NUMBERED PARTS/  
PIEZAS NUMERADAS

EX: 1915X-X 05(peça/ piece/ pieza number)

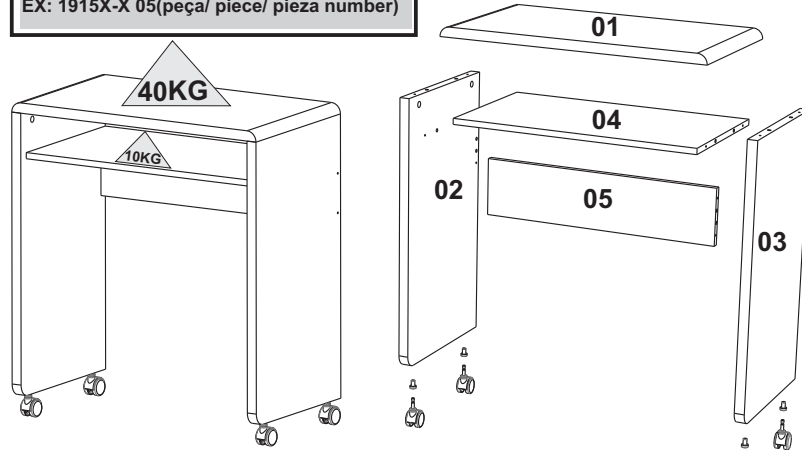

FIXAR PINO DE MINIFIX, TAMBOR E TAMPA / FIXING THE MINIFIX PIN,  
DRUM AND MINIFIX COVER / COLOQUE EL PINO E TAMBOR MINIFIX Y LA TAMPA

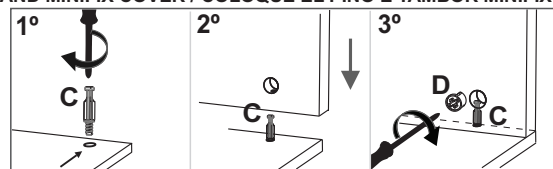

ITEM		DESCRIÇÃO DA PEÇAS / DESCRIPTION OF PARTS / UNIT MEASURE USED IS MILLIMETERS (MM)	CORES/ COLORS/ COLORES				
CÓDIGO CODE	Nº	NOME/NAME/NOMBRE	MEDIDAS / MEASURES (MM)	TIPO TYPE	QUANT AMOUNT CANTIDAD	BRANCO WHITE BLANCO	PTO BLACK NEGRO
8098	1	TAMPO/ TOP	680X385X25	MDF	1	1/5	1/7
8099	2	LAT. ESQUERDA/ LEFT SIDE/ LADO IZQUIERDO	690X385X25	MDF	1	2/5	2/7
8100	3	LAT. DIREITA/ RIGHT SIDE/ LADO DERECHO	690X385X25	MDF	1	3/5	3/7
8101	4	PRATELEIRA/ SHELF/ ESTANTE	630X360X15	MDP	1	4/5	4/7
8102	5	REFORÇO/ REINFORCEMENT/ REFUREZO	630X150X15	MDP	1	5/5	5/7
438	A	PF. / Screw / Tornillo 4,0x40(MM) CH			04		
137	B	Cavilha / Wooden Dowel / Tarugo 8x30(MM)			12		
532	C	Pino Minifix / Minifix Screw 32(MM)			08		
508	D	Tambor Minifix / Minifix Round Nut 15(MM)			08		
252	E	Tampa Minifix / Minifix Cover Cap 15(MM)fix 15 MM			04	BCO	PTO
254	F				04	BCO	PTO
8108	G	Rodízios PL/ Wheels/ Ruedas 40x40x40 MM			04	BCO	PTO
		Certificado Garantia/ Warranty Certif.			01		

## CUIDADOS ESPECIAIS

LIMPEZA- Pano limpo umedecido em água e sabão neutro.  
BRILHO- Flanela seca.

## SPECIAL CARE

CLEANING-Clean cloth moistened with water and mild soap.  
SHINE- Dry cloth.

## CUIDADOS ESPECIALES:

LIMPIEZA- Paño limpio humedecido con agua y un jabón suave.  
BRIGHT- Flanela seca.

## ATENÇÃO / ATTENTION / ATENCION

Nunca utilizar óleos, lustra móveis; produtos abrasivos, saponáceos, esponja de aço e outros.

Never use oils, polish furniture , abrasive products, soaps, steel sponge and others.

Nunca use aceites, pulimentos; abrasivos, jabones, esponja de acero y otros.

Ferramentas necessárias / Necessary tools / Herramientas Necesarias  
(não fornecidas) (not provided) (No proporcionadas)



1



MONTAR O PRODUTO SOBRE A EMBALAGEM, EVITANDO DANOS NA PINTURA.  
ACONSELHAMOS QUE A MONTAGEM DO PRODUTO SEJA POR UM PROFESSIONAL.

SETUP THE PRODUCT ON TOP OF THE PACKAGING, AVOIDING DAMAGE TO THE PAINT.  
WE RECOMMEND THAT THE INSTALLATION IS DONE BY A PROFESSIONAL.

MONTAR EL PRODUCTO EN EL PAQUETE, EVITAR LESIONES EN PINTURA.  
AVISAMOS QUE EL MONTAJE DEL PRODUCTO SEA UN PROFESIONAL.

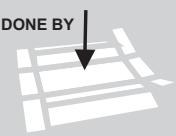

**1**

Obs: As peças pintadas nos passos são apenas ilustrativas.  
The parts painted in the steps are illustrative only.  
Las partes pintadas en los pasos son solo ilustrativas.

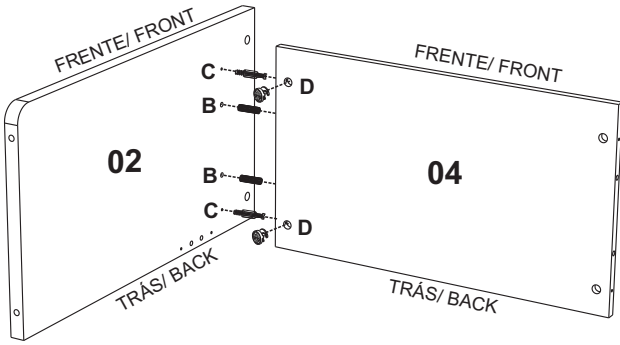

B=02  
C=02  
D=02

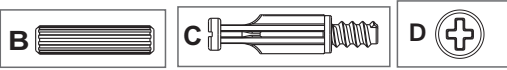
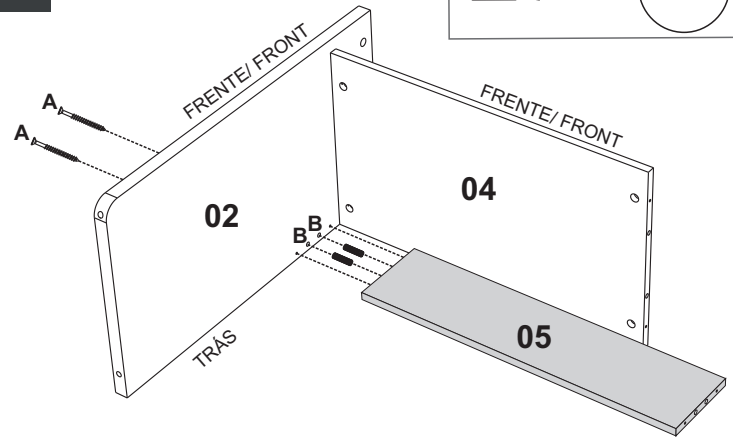
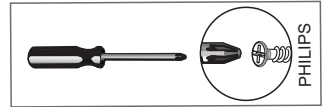
**2**

A=02  
B=02

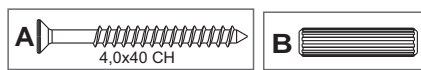
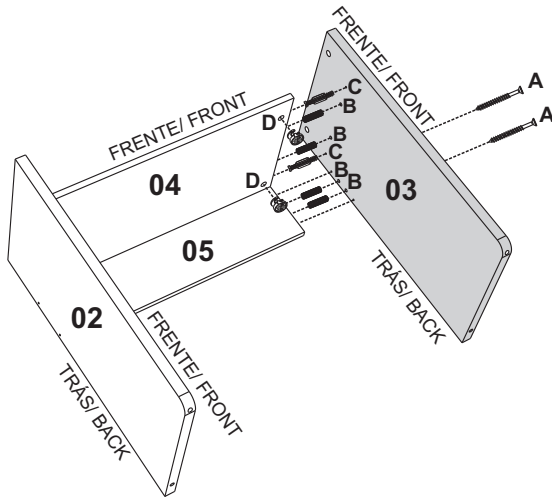
**3**

A=02  
B=04  
C=02  
D=02

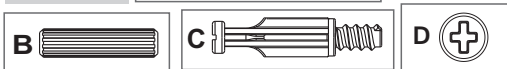
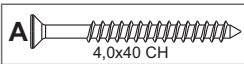
**4**

Encaixar os rodízios e bater com martelo/  
Fit the wheels and hit with hammer/  
Monta las ruedas y golpe con martillo.

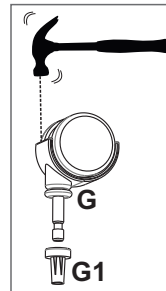
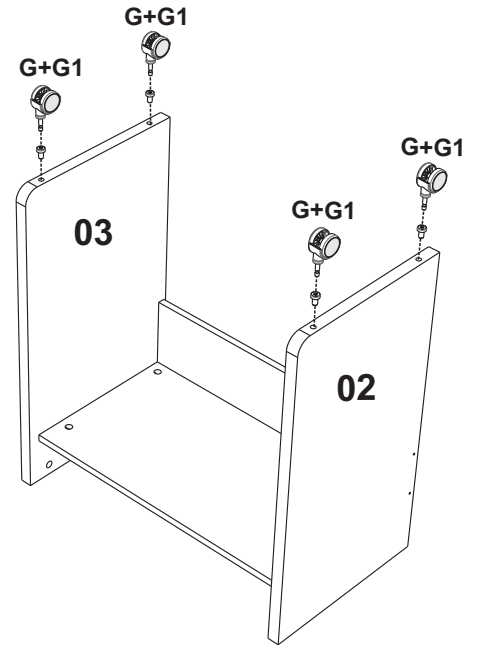
**G=04****5**

B=04  
C=04  
D=04  
E=04  
F=04

