

DIMENSÕES DO PRODUTO / PRODUCT DIMENSIONS / DIMENSIONS PRODUCT - **WxDxH / LxPxA - 500X 340X 235 MM**

PEÇAS NUMERADAS / NUMBERED PARTS / PIEZAS NUMERADAS
 EX: 1915X-X 04 (peça / piece / pieza number)

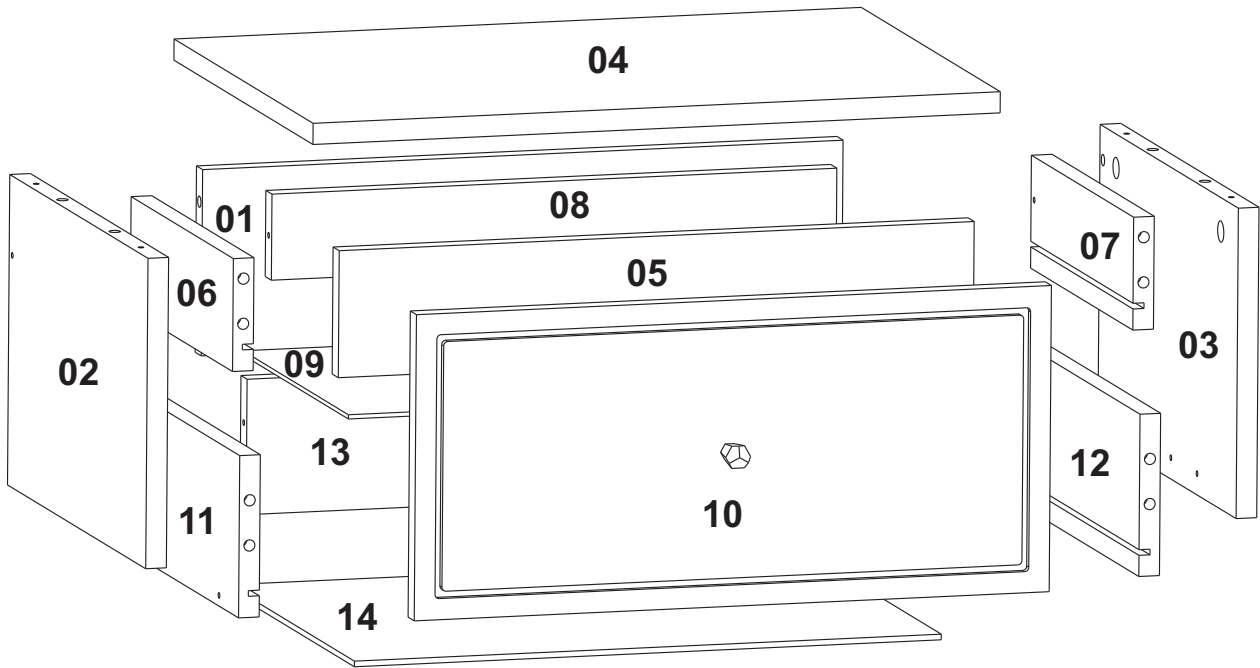
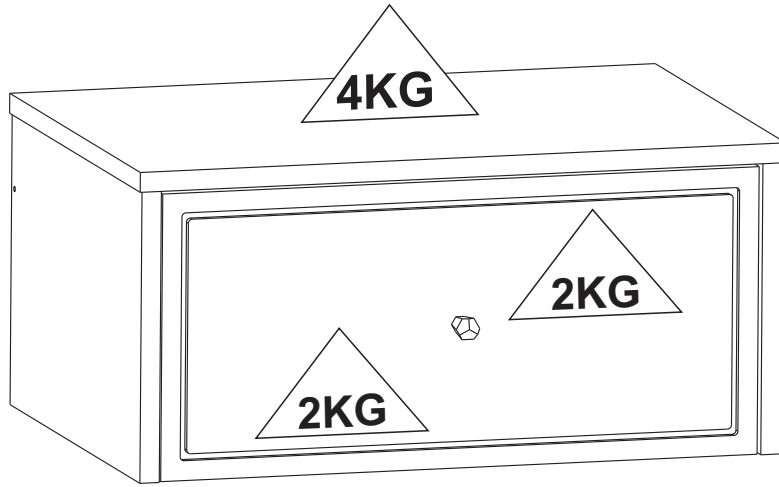

ATENÇÃO / ATTENTION / ATENCION

Nunca utilizar óleos, lustra móveis, produtos abrasivos, saponáceos, esponja de aço e outros.

Never use oils, furniture polish, abrasive products, soaps, steel sponge and others.

Nunca use aceites, pulimentos, abrasivos, jabones, esponja de acero y otros.

CUIDADOS ESPECIAIS / SPECIAL CARE / CUIDADOS ESPECIALES

- Evitar expor o móvel ao sol, e em lugares úmidos.
- Limpar com flanela seca ou com pano levemente umedecido em água.
- Avoid exposing the furniture to the sun, and in damp places.
- Clean with dry flannel or lightly cloth moistened with water.
- Evite exponer los muebles al sol y en lugares húmedos.
- Limpiar con franela seca o un paño ligero, humedecido con agua.

Ferramentas necessárias (não fornecidas) Necessary tools (not provided) Herramientas Necesarias (No proporcionadas)

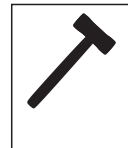
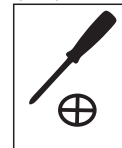

MONTAR O PRODUTO SOBRE A EMBALAGEM, EVITANDO DANOS NA PINTURA. ACONSELHAMOS QUE A MONTAGEM DO PRODUTO SEJA POR UM PROFISSIONAL.

SETUP THE PRODUCT ON TOP OF THE PACKAGING, AVOIDING DAMAGE TO THE PAINT. WE RECOMMEND THAT THE INSTALLATION IS DONE BY A PROFESSIONAL.

MONTAR EL PRODUCTO EN EL PAQUETE, EVITAR LESIONES EN PINTURA. AVISAMOS QUE EL MONTAJE DEL PRODUCTO SEA UN PROFESIONAL.

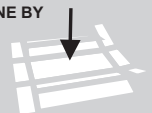

MEDIDA UTILIZADA EM MM/ UNIT MEASURE USED IS MILLIMETERS (MM)

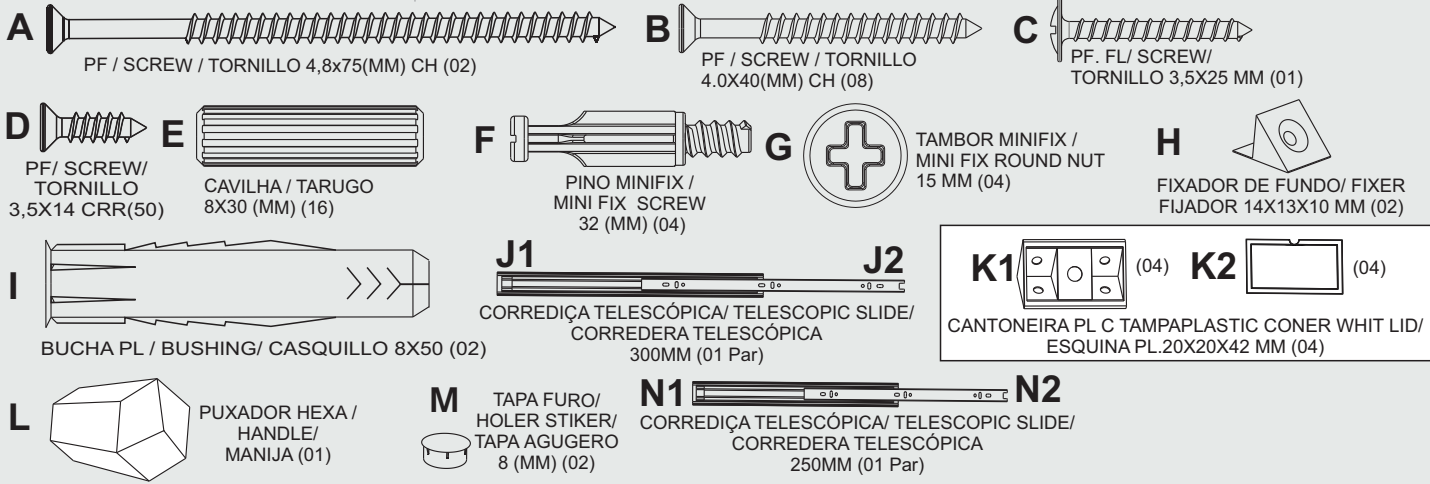

ITEM		DESCRIÇÃO DA PEÇAS / DESCRIPTION OF PARTS / UNIT MEASURE USED IS MILLIMETERS (MM)	CORES PRODUTO/ PRODUCT COLORS/ COLORES PRODUCTO					
CÓDIGO CODE	Nº	NOME/NAME/NOMBRE	MEDIDAS / MEASURES (MM)	TIPO TYPE	QUANT AMOUNT CANTIDAD	BRANCO AC/ WHITE/ BLANCO (CÓD. 06)	PRETO AC/ BLACK/ NEGRO (CÓD. 07)	OFF WHITE/ CINZA AC (CÓD. 12)
19554	01	PAINEL TRAS/ BACK PANEL/ PANEL TRASERO	466X132X15	MDP	01	01/05	01/07	01/12
19553	02	LATERAL ESQUERDA/ LEFT SIDE/ LADO IZQUIERDO	338X220X15	MDP	01	02/05	02/07	02/12
19555	03	LATERAL DIREITA/ RIGHT SIDE/ LADO DERECHO	338X220X15	MDP	01	03/05	03/07	03/12
19556	04	TAMPO / TOP/ PARTE SUPERIOR	500X340X15	MDP	01	04/05	04/07	04/12
19562	05	FRENTE GAVETA SUP./ DRAWER FRONT/ FRENTE DE CÁJON	462X90X15	MDP	01	05/05	05/07	05/12
19563	06	LAT.GAV.ESQ.SUP/ LEFT DRAWER SIDE/ LADO CAJÓN IZQUIERDO	250X80X15	MDP	01	06/05	06/07	06/12
19564	07	LAT.GAV.DIR.SUP/ RIGHT DRAWER SIDE/ LADO CAJÓN DERECHO	250X80X15	MDP	01	07/05	07/07	07/12
19565	08	CONTRA FRENTE SUP./ AGAINST DRAWER FRONT/CONTRA EL FRENTE DEL CAJÓN	411X61X15	MDP	01	08/05	08/07	08/12
19566	09	FUNDO GAV. SUP/ DRAWER BACKGROUND/FONDO DEL CAJÓN	427X258X3	MDF	01	09/05	09/07	09/12
19557	10	FRENTE GAVETA/ DRAWER FRONT/ FRENTE DE CÁJON	462X217X15	MDF	01	10/05	10/07	10/12
19558	11	LAT.GAV.ESQ./LEFT DRAWER SIDE/ LADO CAJÓN IZQUIERDO	300X115X15	MDP	01	11/05	11/07	11/12
19559	12	LAT.GAV.DIR./ RIGHT DRAWER SIDE/ LADO CAJÓN DERECHO	300X115X15	MDP	01	12/05	12/07	12/12
19560	13	CONTRA FRENTE GAV/AGAINST DRAWER FRONT/CONTRA EL FRENTE DEL CAJÓN	411X96X15	MDP	01	13/05	13/07	13/12
19561	14	FUNDO GAV./DRAWER BACKGROUND/FONDO DEL CAJÓN	427X308X3	MDF	01	14/05	14/07	14/12
438	A	PF./ Screw / Tornillo 4,8X75 CH (MM)			02			
8233	B	PF. / Screw / Tornillo 4,0x40(MM) CH			08			
986	C	PF. / Screw / Tornillo 3,5x25(MM) CH			01			
137	D	PF. / Screw / Tornillo 3,5x14(MM) CRR			50			
532	E	Cavilha / Wooden Dowel / Tarugo 8x30(MM)			16			
508	F	Pino Minifix / Minifix Screw 32(MM)			04			
9514	G	Tambor Minifix / Minifix Round Nut 15(MM)			04			
2922	H	Fixador de Fundo/ Back Fixed/ Fijador 14X13X10 MM			02	PRETO	PRETO	PRETO
13036	I	Bucha Pl/ Bushing/ Casquillo 8X50 Cinza			02	CINZA	CINZA	CINZA
15175	J1/J2	Corred.Telescópica/ Metalic Slid/ Corredera Metálica 300(MM) (01 Pair)			01			
19517	K1/K2	Cantoneira PL/Plast. corner with lid/ Esquina PL. 20X20X42(MM)			04	CINZA	CINZA	CINZA
7687	L	Puxador Hexa Akeo/ Handle/ Manija			01			
952	M	Tapa Furo /Holer Sticker/Tapa Agugero 8 mm			02	BRANCO	PRETO	
7718								CINZA
18147	N1/N2	Corred.Telescópica/ Metalic Slid/ Corredera Metálica 250(MM) (01 Pair)			01			
		Certif. de Garant./ Warranty Certif.			01			

PREPARAÇÃO DE PEÇAS/ PARTS PREPARATION/ PREPARACION DE PIEZAS

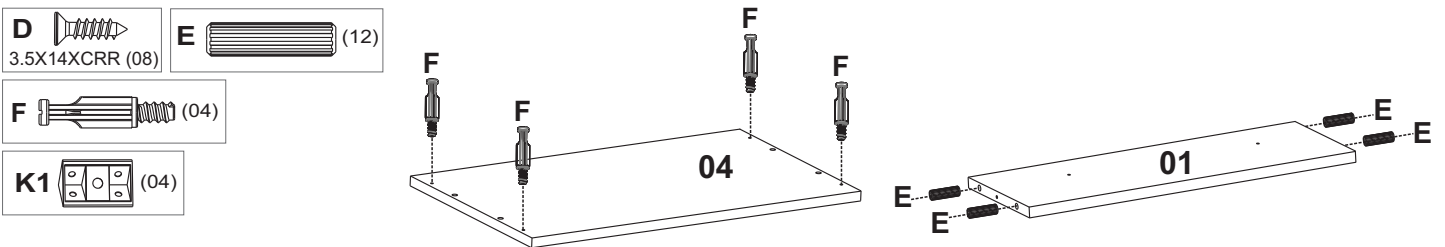

Parafusar as cantoneiras entre as cavilhas./ Screw the plastic corner between the wooden dowel. Atornillar las esquinas entre las tarugos.

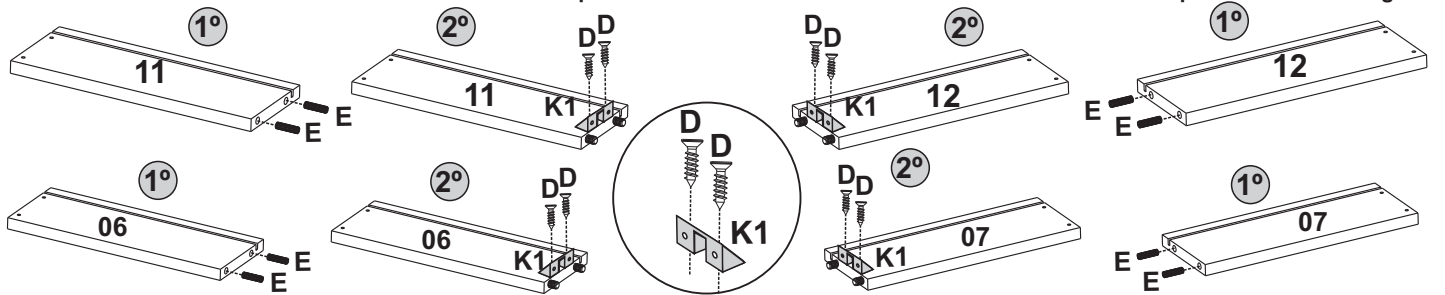

PREPARAÇÃO DE PEÇAS/ PARTS PREPARATION/ PREPARACION DE PIEZAS

D  3.5X14XCRR12

E  (04)

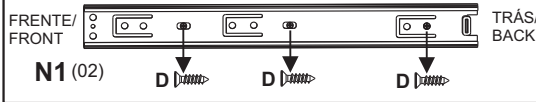

CORREIÇA / TELESCOPIC SLIDE/ CORREDERA TELESCÓPICA 250MM

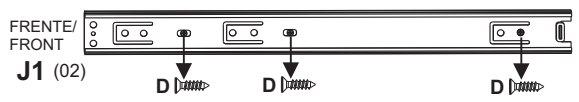
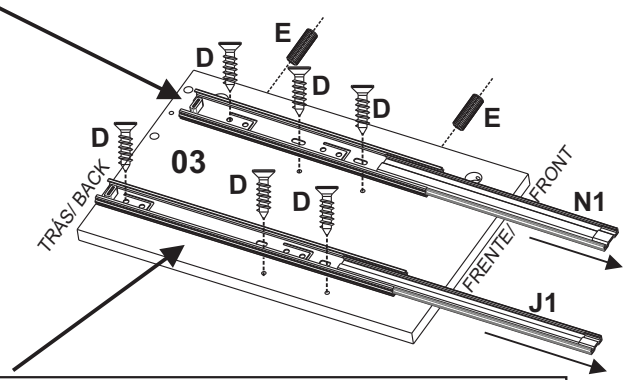
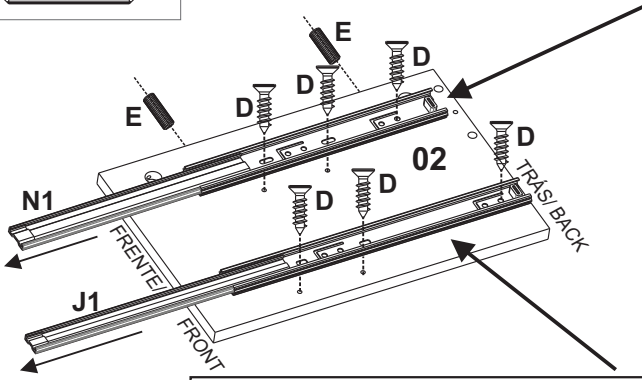

CORREIÇA / TELESCOPIC SLIDE/ CORREDERA TELESCÓPICA 300MM

Obs: As peças pintadas nos passos são apenas ilustrativas. The parts painted in the steps are illustrative only. Las partes pintadas en los pasos son solo ilustrativas.

1

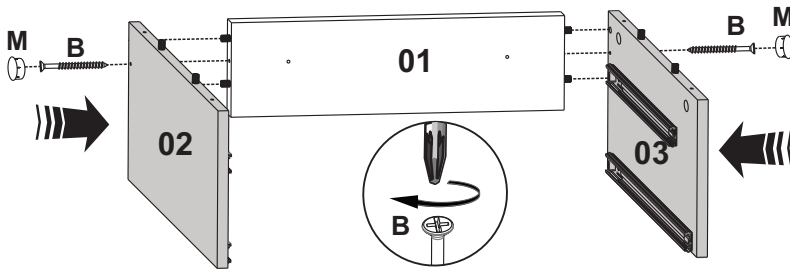

2

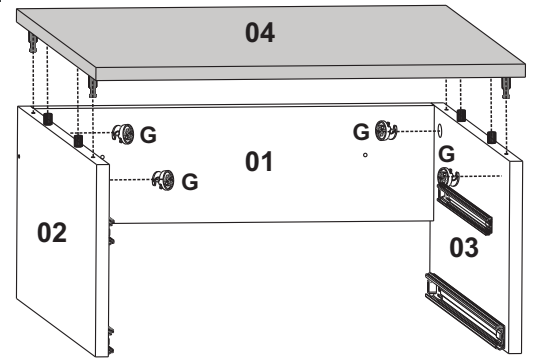

B=02
M=02

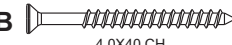
B  4.0X40 CH

M 

G=04

G 

3

MONTAGEM DA GAVETA SUPERIOR / ASSEMBLY OF THE TOP DRAWER / MONTAJE LE CÁJON SUPERIOR

1º

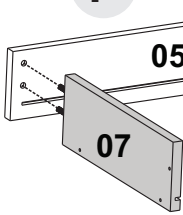

2º

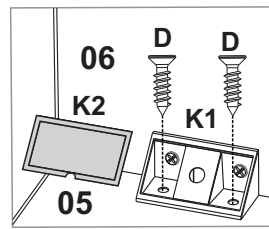
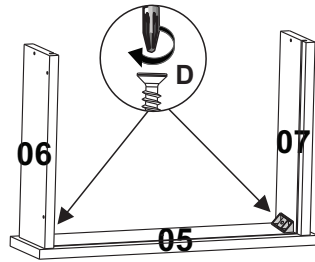
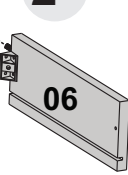

3º

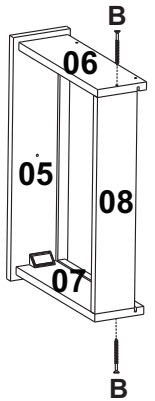
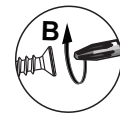

4º

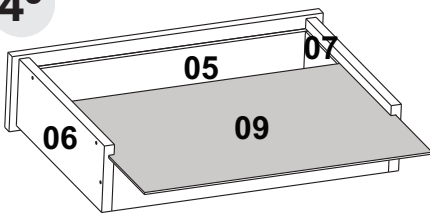

5º

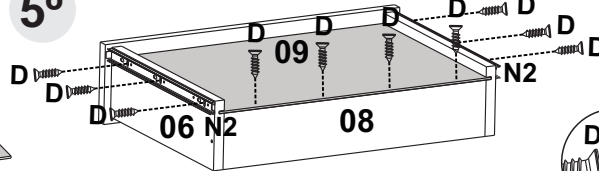

6º

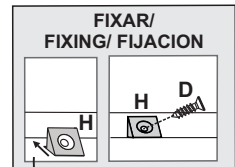

CORREIÇA / TELESCOPIC SLIDE/ CORREDERA TELESCÓPICA 250MM

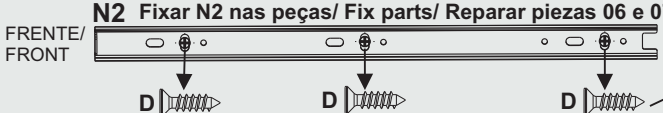

B=02
D=15
H=01
K2=02
N2=02

B  4.0X40 CH

D  3.5X14 MM

H 

K2 

N2 

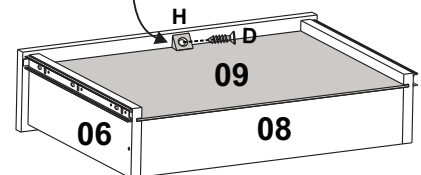

4 MONTAGEM GAVETA INFERIOR/ LOWER DRAWER ASSEMBLY / MONTAJE LE CÁJON INFERIOR

1º

2º

3º

4º

5º

6º

Legend:
 B=04
 C=01
 D=15
 H=01
 J2=02
 K2=02
 L=01

! CORREDIÇA / TELESCOPIC SLIDE/ CORREDERA TELESCÓPICA 300MM
J2 Fixar J2 nas peças/ Fix parts/ Reparar piezas 11 e 12.
 FRENTE/ FRONT TRÁS/ BACK

Parts List:
 B: 4.0X40 CH
 D: 3,5X14 MM
 H: [Image of cam bolt]
 J2: [Image of telescopic slide]
 K2: [Image of cam lock]
 C: 3,5 x 35 FL
 L: [Image of cam bolt]

5 FIXAÇÃO PAREDE/ WALL FIXING/ FIJACIÓN A LA PARED

! ATENÇÃO/ ATTENTION/ ATENCION
 A ALTURA PARA FIXAÇÃO É OPCIONAL/ THE HEIGHT TO FIXING IS OPTIONAL/ LA ALTURA PARA FIJAR ES OPCIONAL

1º

2º

3º

4º

5º

Legend:
 A=02
 I=02

Parts List:
 A: [Image of long screw]
 I: [Image of wall plug]

NOTA / NOTE Não nos responsabilizamos por acidentes, se a instalação do móvel não estiver com os procedimentos deste Manual e não for realizado por pessoa habilitada. We are not responsible for accidents if the installation of the furniture is not in accordance with the procedures in this Manual and is not carried out by a qualified person. No nos hacemos responsables de accidentes si la instalación de los muebles no se realiza de acuerdo con los procedimientos de este Manual y no es realizada por una persona calificada.