



RELAÇÃO DE FERRAGENS EM TAMANHO REAL (MEDIDA EM MILÍMETRO).

166 UNIDADES



A - PARAF. 3,5x14

36 UNIDADES



B - PARAF. 5x40

12 UNIDADES



C - PARAF. 3,5x25

08 UNIDADES

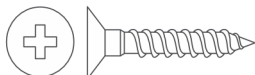

D - PARAF. 3,5x35

08 UNIDADES



E - CANTONEIRA 4 FUROS

02 UNIDADES

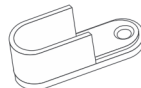

F - SUPORTE CABIDEIRO

08 UNIDADES



G - CAVILHA 6x30



H - PREGO 10x10

06 UNIDADES

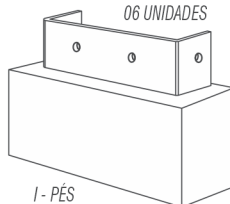

I - PÉS

15 UNIDADES

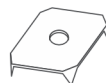

J - FIXADOR DE COSTAS

28 UNIDADES



K - TAMPA ADESIVA

06 UNIDADES



M - PUXADOR

12 UNIDADES

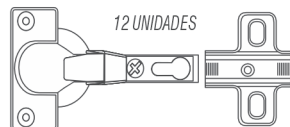

N - DOBRADIÇA

O - CALÇO

1 UNIDADE



P - CABIDEIRO

02 UNIDADES

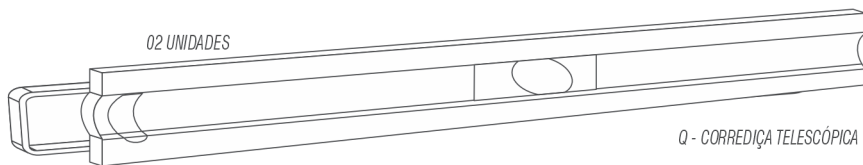

Q - CORREDIÇA TELESCÓPICA

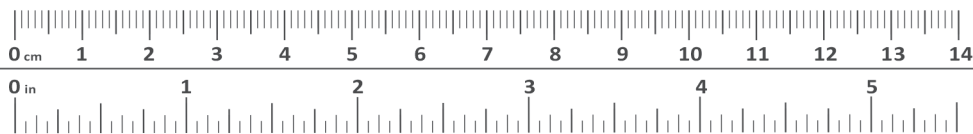

3

UTILIZE A RÉGUA PARA A MEDIÇÃO DOS PARAFUSOS

FAVOR IDENTIFICAR AS PEÇAS E COLOCAR SEUS RESPECTIVOS ACESSÓRIOS

Sequência de Montagem

- 01 - Parafusar peça 2 nas peça 3;
- 02 - Parafusar peça 1 nas 2;
- 03 - Parafusar peça 4 nas peças 2;
- 04 - Parafusar os Pés 21 nos rodapés 2.

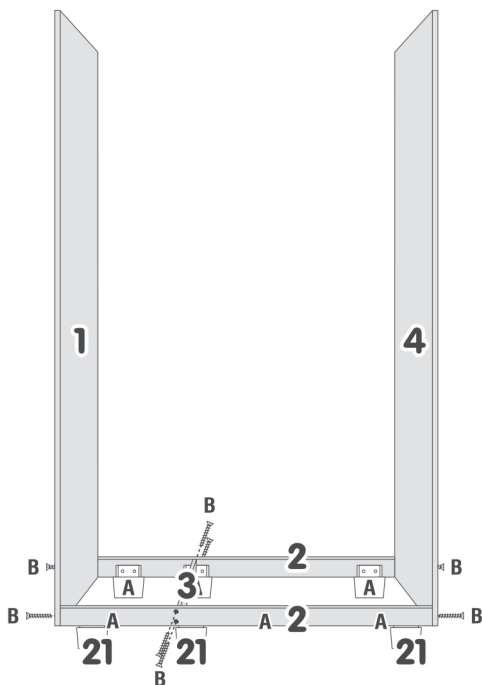
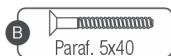

Sequência de Montagem

- 05- Parafusar peça 5 nas peças 2;
- 06- Parafusar as peça 6 na peça 5 conforme desenho

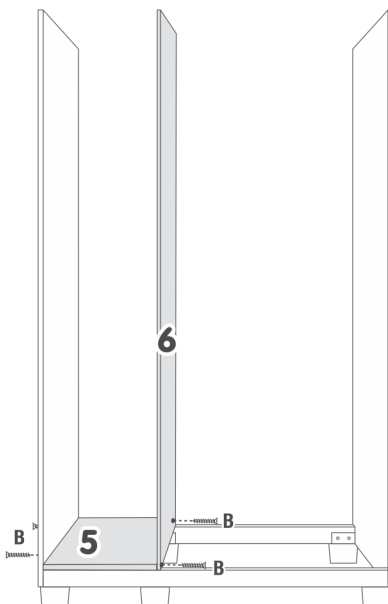

Sequência de Montagem

07 - Parafusar as peças 5 e 10 nas peças 1, 4 e 6.

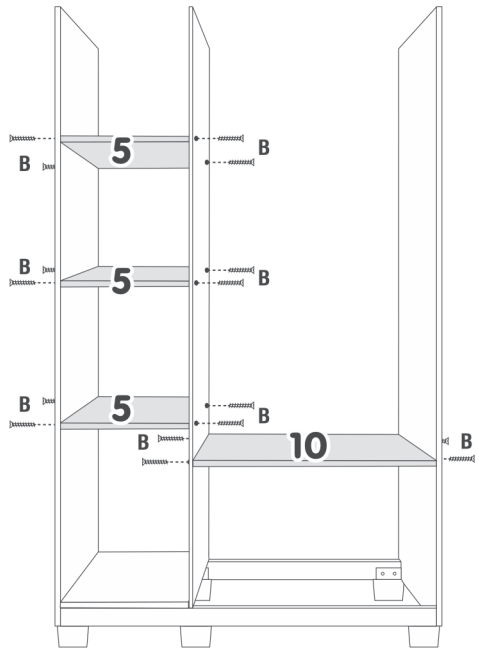

Sequência de Montagem

08 - Parafusar as peças 12 nas peças 1, 4 e 6.

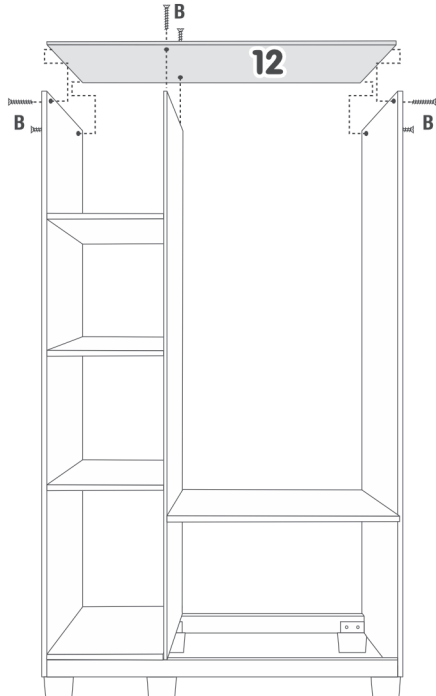

Sequência de Montagem

09 - Parafusar a peça 13 nas peças 1, 4, e 12.

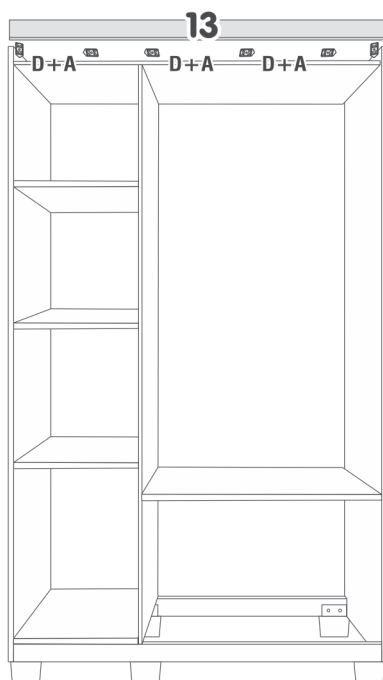

Sequência de Montagem



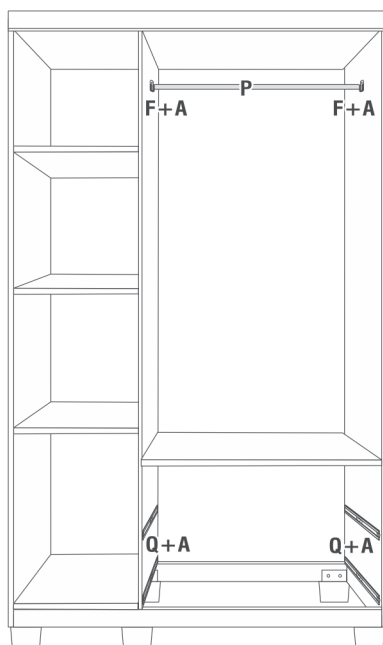

- 10 - Parafusar as corredeiras nas peças 4 e 6;
11 - Parafusar suporte de cabideiro conforme desenho ao lado.

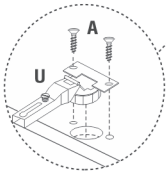

Seqüência de Montagem

12 - Montar e fixar as Portas 14 e 15.



- A**  Paraf. 3,5x14
- C**  Paraf. 3,5x25
- M**  Puxador
- N**  Dobradiça Pressão
- O**  Calço

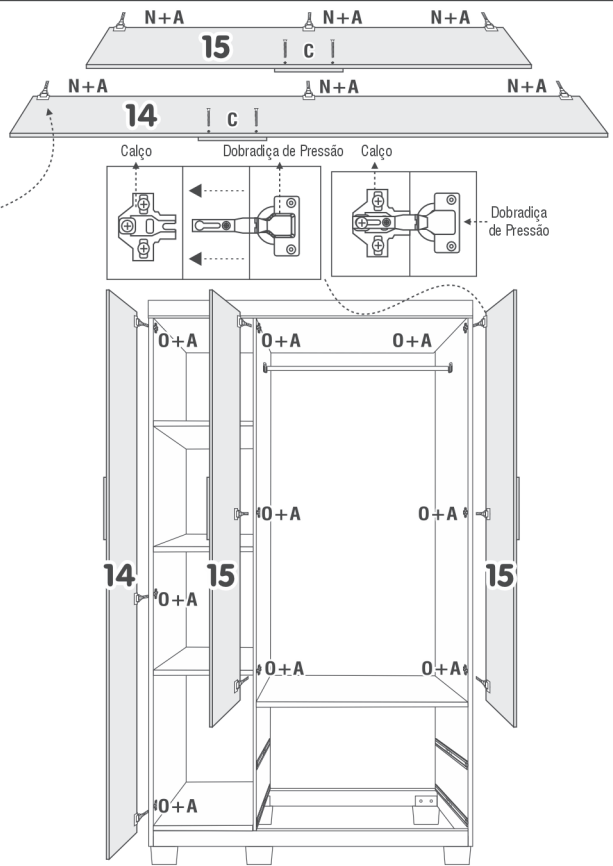

Seqüência de Montagem

13 - Pregiar as Costas 20 e 22 conforme desenho ao alado.

OBS.: Acertar as costas para melhor esquadrejamento do móvel.

- H**  Prego 10x10
- J**  Fixador de Costas

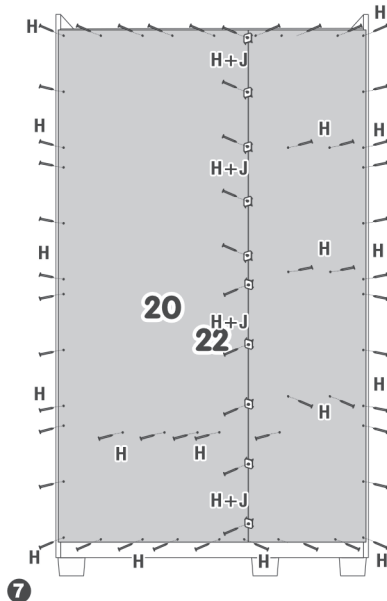

Seqüência de Montagem

- 14 - Parafusar as cantoneiras nas peças 17;
- 15 - Parafusar as peças 17 nas peças 16;
- 16 - Parafusar a peça 18 nas peças 17;
- 17 - Parafusar peça 19 nas peças 17 e 18 conforme desenho abaixo, ajustando para melhor esquadrejamento da Gaveta;
- 18 - Parafusar as corredeiras nas laterais da peça 17.

