

Manual de montagem

Instrucciones de montaje Assembly instructions

PA2AMDP342

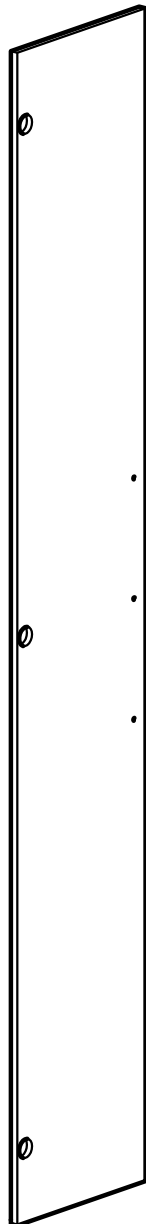

! Imagens meramente ilustrativas !
Imágenes ilustrativas/Images merely illustrative.

Dúvidas? Entre em contato:
Dudas? Ponerse em contacto:
Doubts? Get in touch:
(51) 3635-8839

A montagem deve ser efetuada por 2 pessoas.

El montaje debe ser efectuada por 2 personas.

The assembly must be done by 2 people.

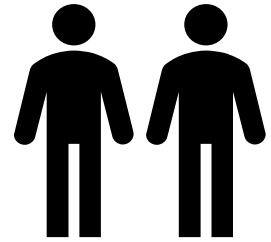

Ferramentas necessárias para montar o móvel.

Herramientas necesarias para armar el mueble
Tools needed to assemble the furniture.



Dúvidas? Entrar em contato:

Dudas? Ponerse en contacto:

Doubts? Get in touch:

Fone: (51) 3635-8839

www.kappesberg.com.br



Montar o móvel sobre uma superfície limpa e plana.

Armar el mueble sobre una superficie limpia y plana.

Assemble the furniture on a clean, flat surface.

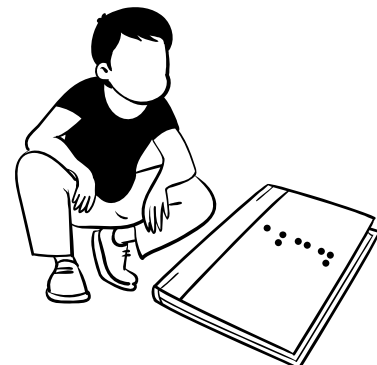

**IDENTIFICAÇÃO DAS PEÇAS / IDENTIFICACIÓN DE LAS PIEZAS PARTS
IDENTIFICATION**

QTD.	CÓDIGO / CODE	DESCRIÇÃO	Descripción	Description	C x L x E	L x W x T
2	P102486	PORTA	PUERTA	DOOR	2177 x 344 x 15 mm	85.71 x 13.54 x 0.59 in

IDENTIFICAÇÃO DAS PEÇAS / IDENTIFICACIÓN DE LAS PIEZAS PARTS
IDENTIFICATION

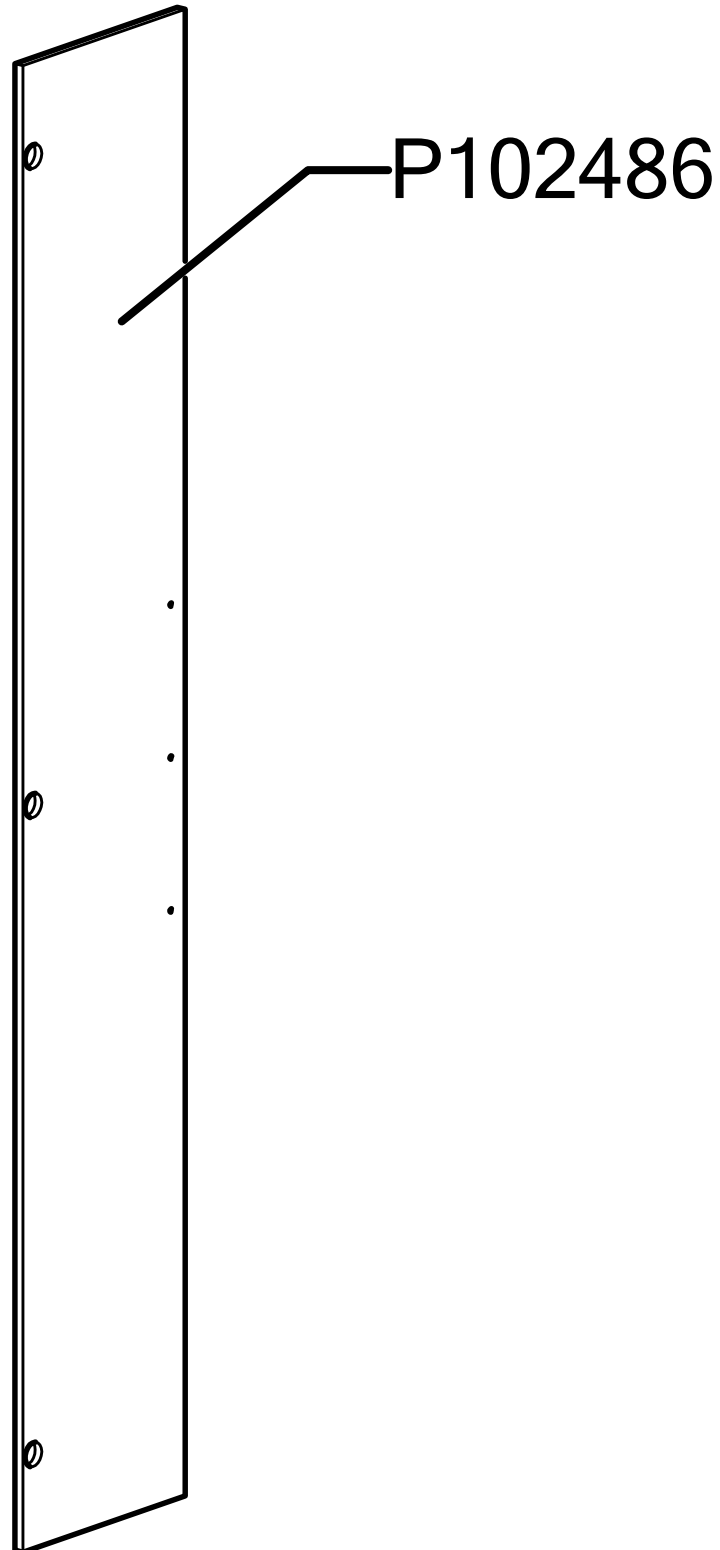

PA2AMDP342

Cod.	Qtde.
P102486	2

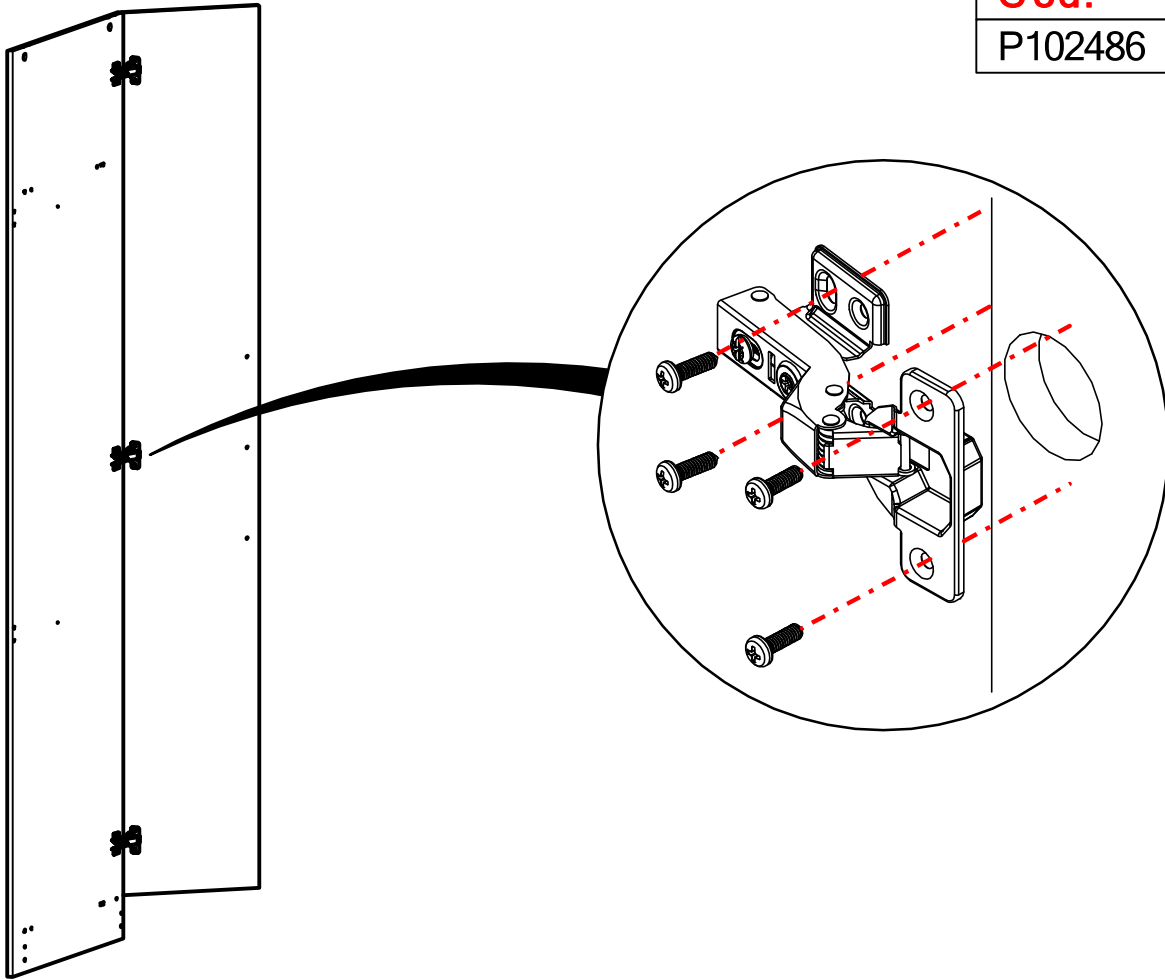

Ajuste de portas Ajuste de puerto Doors Adjustment

Ajuste de altura Height Adjustment

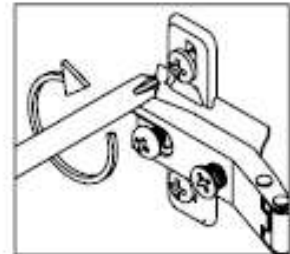
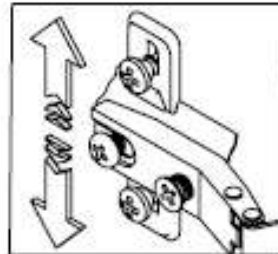
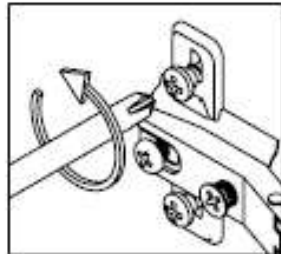
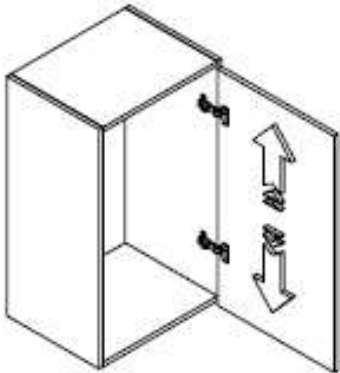

Ajuste Interno Internal Adjustment

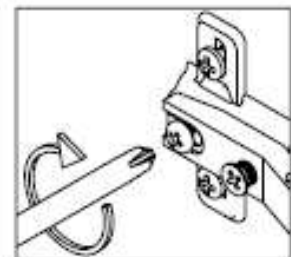
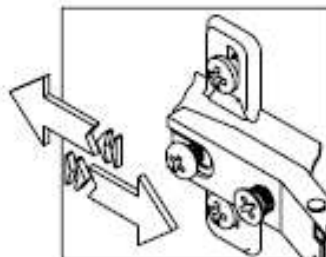
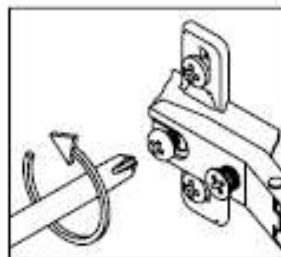
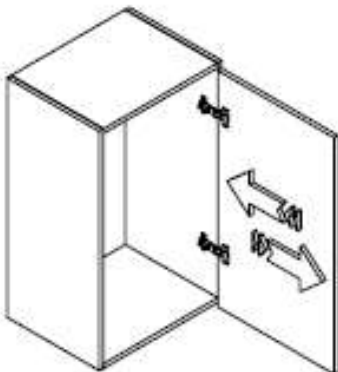

Ajuste de Profundidade Ajuste de profundidad Depth Adjustment

