























FERRAGENS / herrajes / hardware

A	Parafuso 3,5 x 40 Tornillo 3,5 x 40 Screw 3,5 x 40		34
B	Puxador Tirador Handle		2
C	Roldanas		6
D	Parafuso 3,5 x 25 c/c Tornillo 3,5 x 25 Screw 3,5 x 25		2
E	Prego 10 x 10 c/c Clavo 10 x 10 Nail 10 x 10		110
F	Parafuso 3,5 x 12 c/c Tornillo 3,5 x 12 Screw 3,5 x 12		80
G	Prego 13 x 15 c/c Clavo 13 x 15 Nail 13 x 15		8
H	Fixador Fijador Fixer		16
I	Suporte Apoyo Support		8
J	Suporte Cabideiro Apoyo Percha Support Hanger		4
K	Cantoneira 22x22 Esquinera Corner		10
L	Sapata Zapata Shoe		8
M	Cavilha 6 x 30 Tacos Pegs		10
N	Corrediça Metálica 350mm Corrediza Slider		2
O	Distanciador p/ Corrediças Distanciador Distancer		8
P	Parafuso 3,5 x 16 c/c Tornillo 3,5 x 16 Screw 3,5 x 16		24
Q	Parafuso 3,5 x 14 c/c Tornillo 3,5 x 14 Screw 3,5 x 14		2
R	Cola Pegamento Glues		1
U	Cavilha 6 x 50 Tacos Pegs		10
X	Suporte Cabideiro Apoyo Percha		1
T	Trilho pvc (U) superior		1
Z	Trilho aluminio inferior		1

MATERIAL PARA MONTAGEM Material Para Armado / Assembly Material

MARTELO
Martillo
Hammer

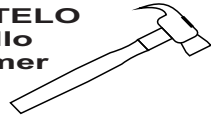

CHAVE
Destornillador
Screwdriver

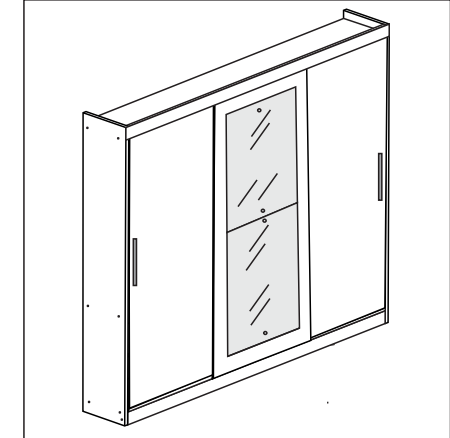
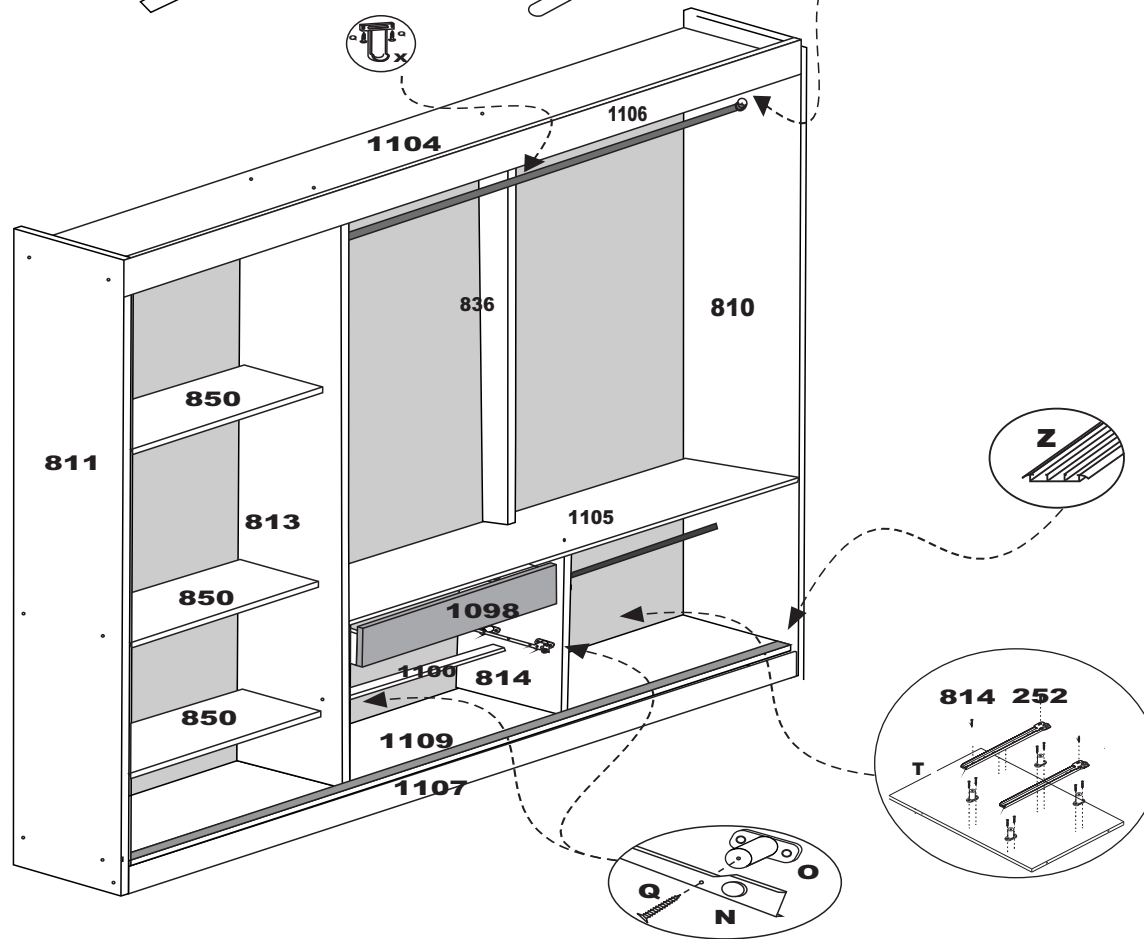

NUMERAÇÃO DE PEÇAS

1100	Reforço entre gavetas
811	Lateral Esquerda / Lateral izquierda/ left side
810	Lateral direita / Lateral derecha/ right side
1107	Rodapé Frontal / Rodepié Frente/ front footer
1108	Rodapé traseiro / Rodapié trazero/ back drawer
1106	Roda-forro / Roda-forro/wheel - liner
1098	Frente gaveta / Delantera cajón/ back drawer
122	Lateral gaveta / Lateral cajón/ side drawer
1103	Trazeiro gaveta / Trazeiro cajón/ back side drawer
1101	Fundo gaveta / Fondo cajón/ back drawer
1102	Costas / Espalda/ back
1110	Porta central / Puerta/big door
1104	Tampo superior / Tampo superior/ top higher
1109	Tampo baixo / Tampo abajo/ top dawn
813	Divisão / División
850	Prateleira Móvel / Prateleira Mueble/mobile
836	Pilastras
820	Tampo Meio
814	Divisão / División
1099	Porta lateral / Puerta/big door

ACESSÓRIOS

N°	DESCRIÇÃO
00086	Pau cabide / Madera percha/stick hanger
101	Espelhos
1520-l	Trilho baixo
1520-s	Trilho cima
039	Pau cabide / Madera percha/stick hanger

1º Passo / 1 Paso / 1 Step

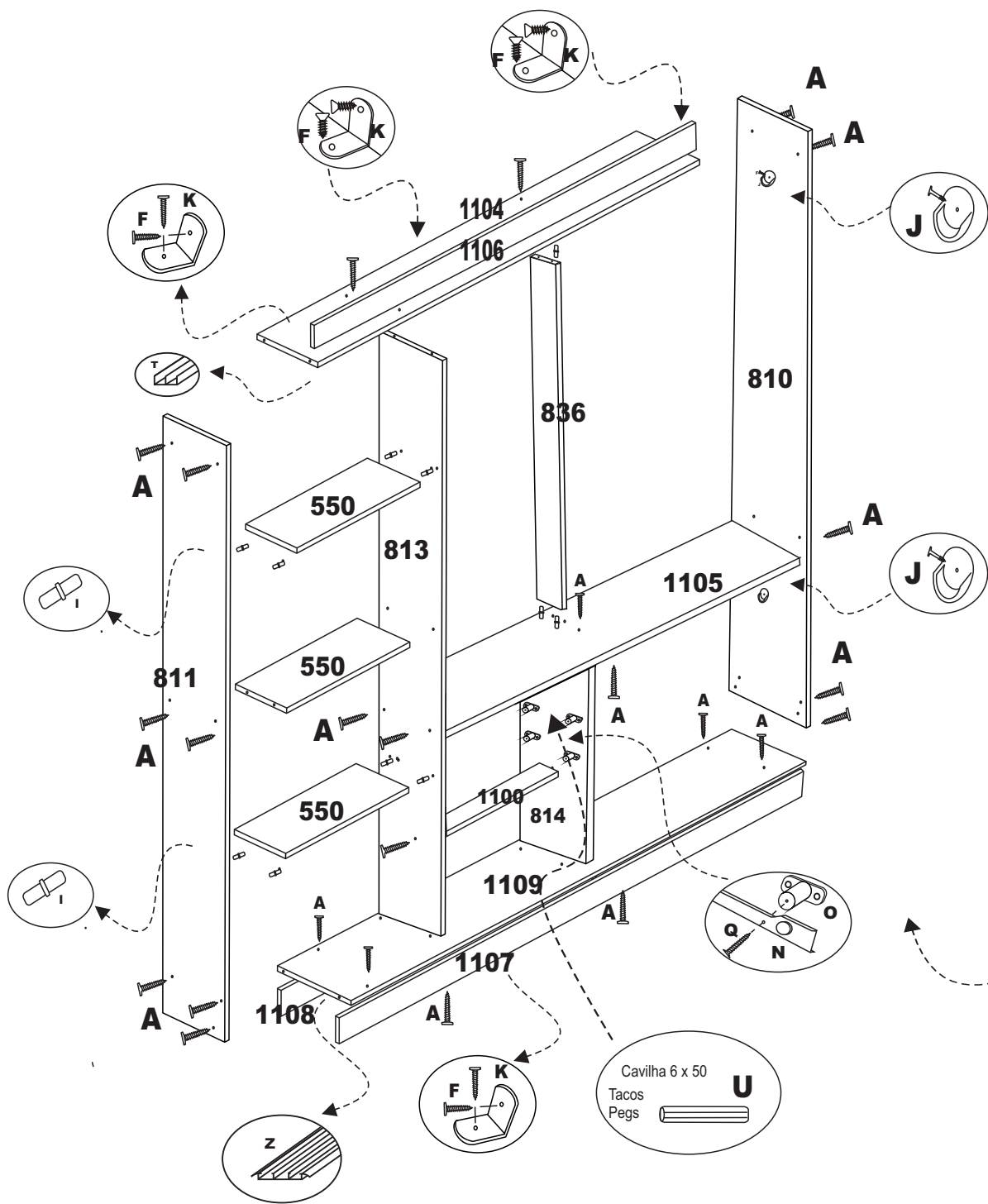

2º Passo / 2 Paso / 2 Step

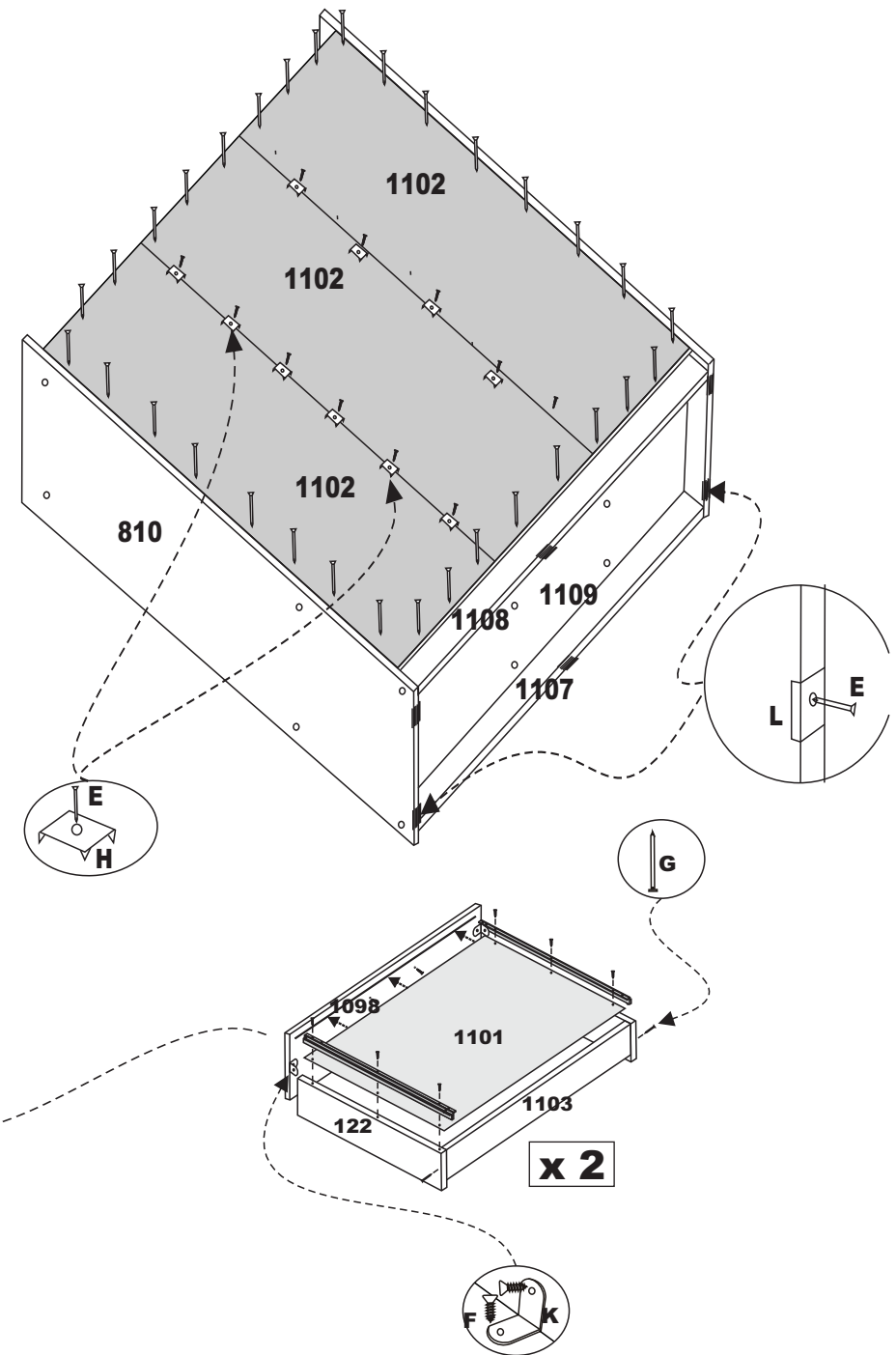

ATENÇÃO MONTAGEM TRILHOS

3º Passo / 3 Paso / 3 Step

Obs:

Na parte de cima, encaixa a porta dentro do trilho 'U'.

Observación:

En la parte superior, se ajusta a la puerta en la barra 'U'.

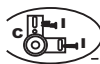

x 3

1110 porta central

Obs:
Na parte de cima, encaixa a porta dentro do trilho 'U'.
Observación:
En la parte superior, se ajusta a la puerta en la barra 'U'.

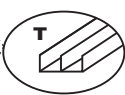

Obs:
Parte de Baixo da Porta
ROLDANA
Observación:
Parte inferior de la puerta
POLEA

Tampo Superior
Cubierta Superior

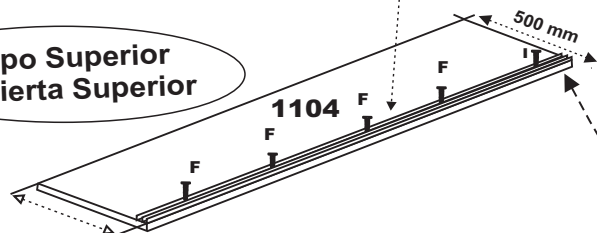

Roda-forro / Roda-forro/wheel - liner

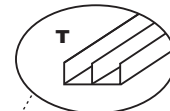

TRILHO SUPERIOR

1099

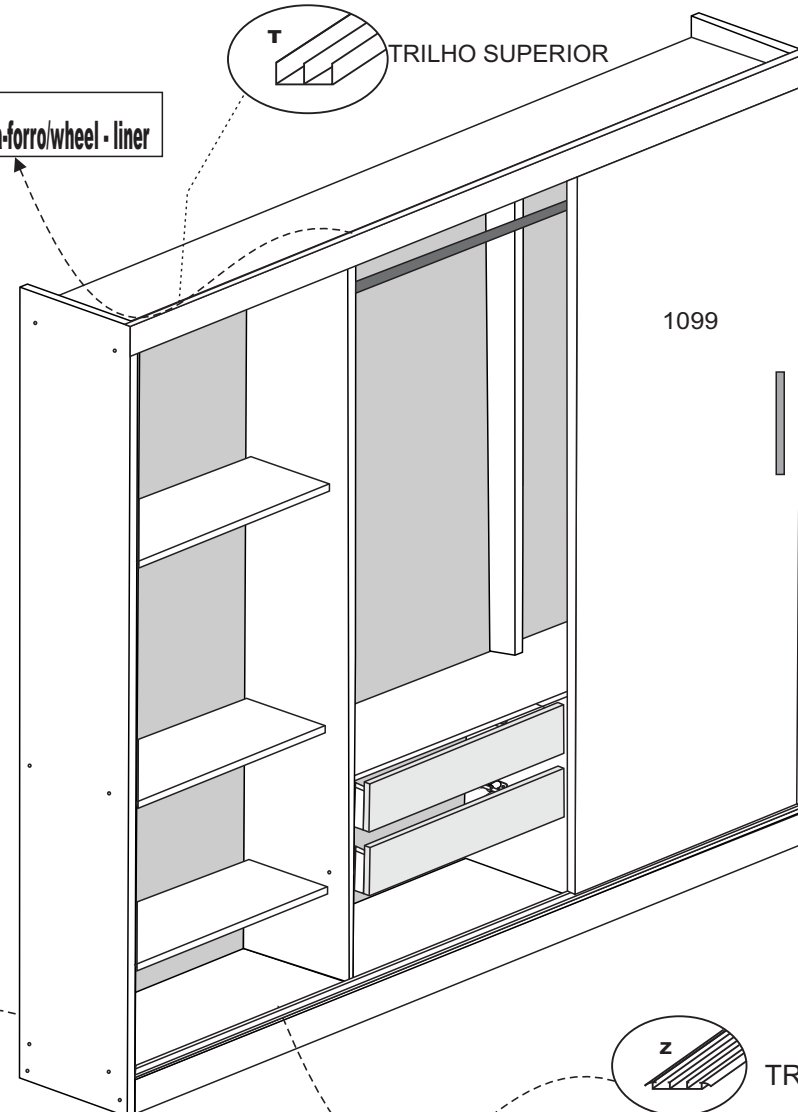

Tampo Inferior
Cubierta Inferior

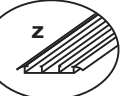
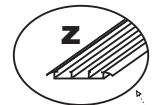
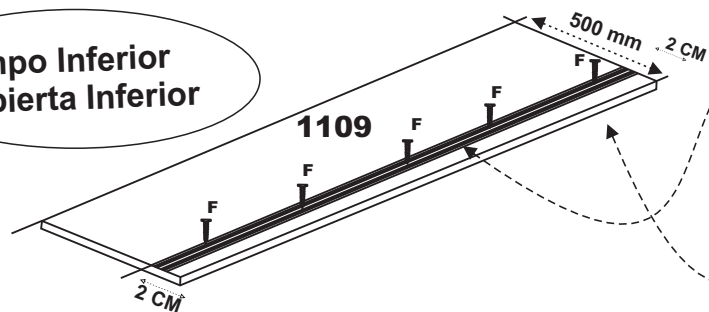

TRILHO INFERIOR

4º Passo / 4 Paso / 4 Step

**ATENÇÃO MONTAGEM PORTAS
ESPELHOS. PUXADORES**

*Por puxadores, portas lateral
do roupeiro.*

*Por espelho , porta
central do roupeiro*

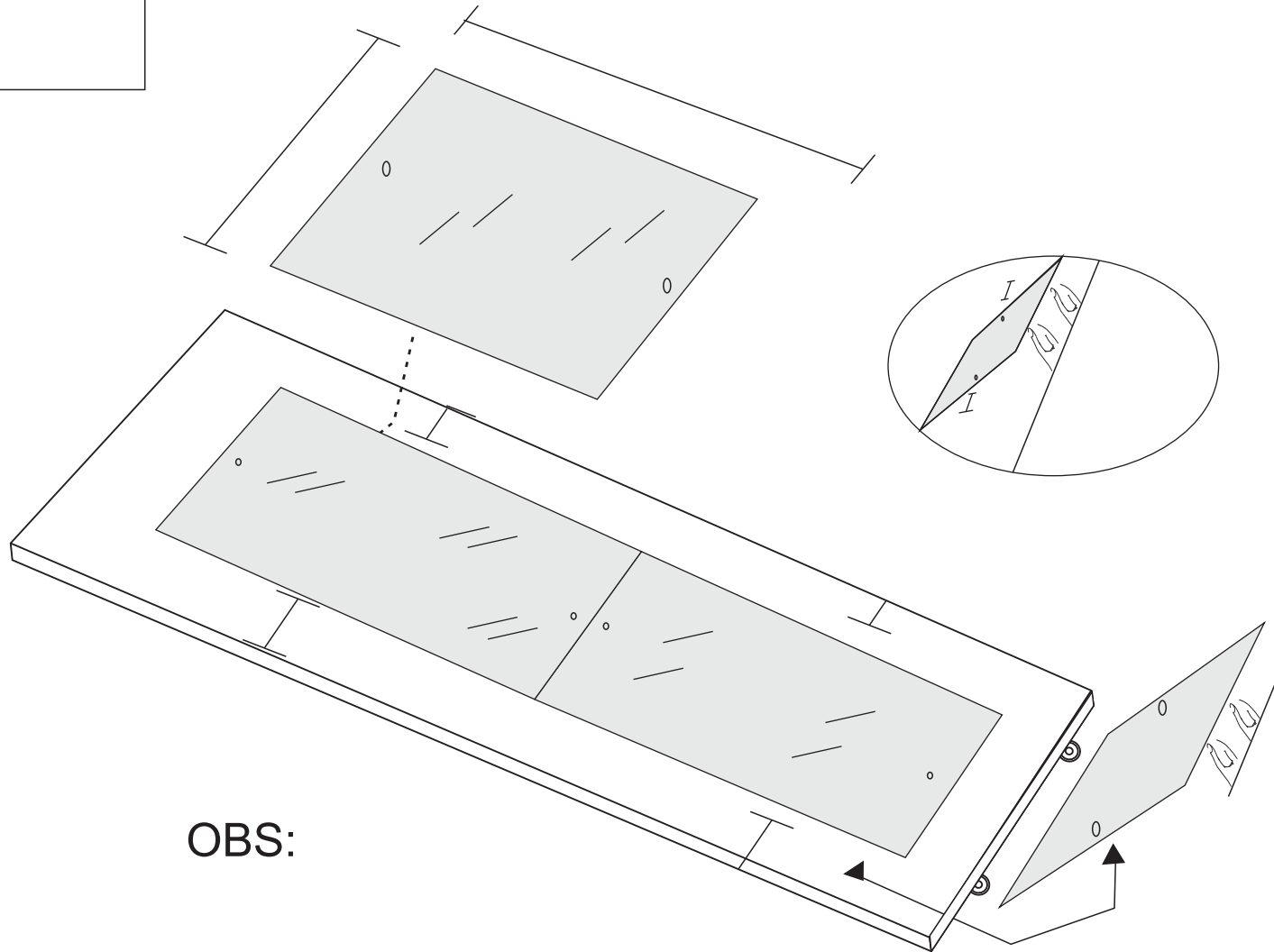
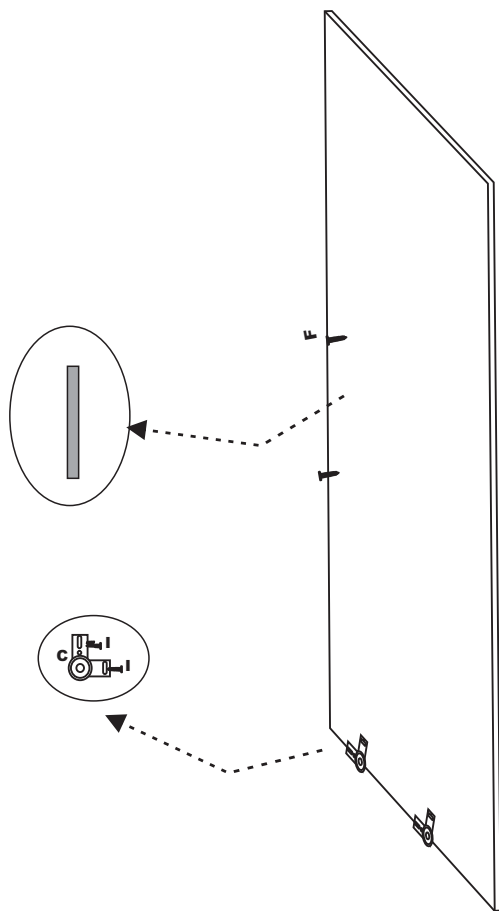

OBS:

PARA INICIAR A MONTAGEM ESPELHO
DEIXANDO A MEDIDA LATERAL COM ... MM CADA
LADO DA PORTA.
COMO MOSTRA DESENHO
E EMPARAFUSAR O ESPELHOS NA PORTA.