

Doripel

móveis

MANUAL DE MONTAGEM
ASSEMBLE INSTRUCTIONS
INSTRUCCIONES DE ARMADO

RP 60800
RP 68500
RP 70300
RP 45850

Roupeiro 08 Pts

Acesse a Instrução de montagem completa pelo QRCode.

Access the complete assembly instructions via QRCode.

Accede las instrucciones de montaje completas mediante QRCode.



RP 60800

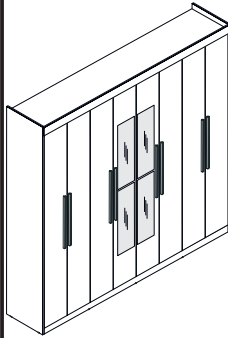

ESPELHO OPCIONAL
OPTIONAL MIRROR
ESPEJO OPCIONAL

RP 68500

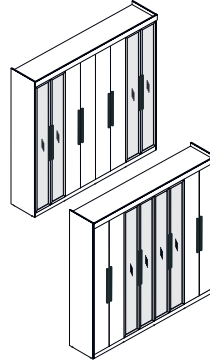

PORTA REFLECTA
REFLECTA DORR
PUERTA REFLECTA

RP 70300

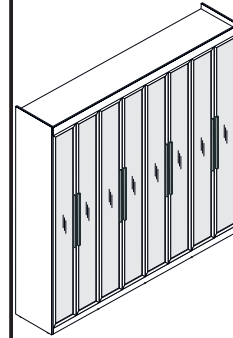

PORTA REFLECTA
REFLECTA DORR
PUERTA REFLECTA

RP 45850

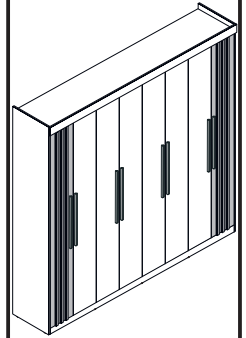

PORTA RIPADA
SLATTED DOOR
PUERTA RANURADA

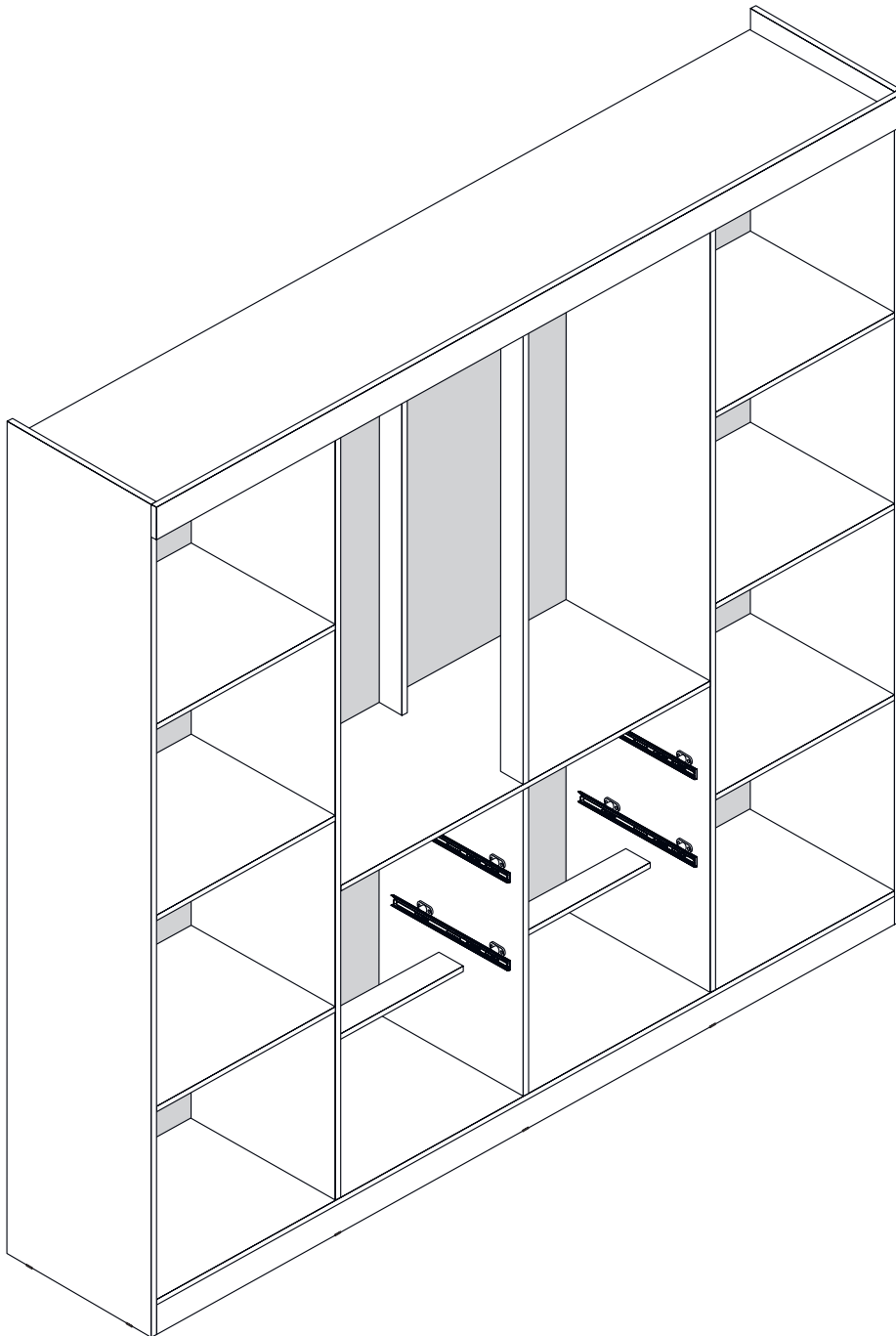

INSTRUÇÕES DE MONTAGEM DO ROUPEIRO

- 1- Começa preparando o espaço onde vai ser montado o roupeiro. Forre o chão para que não arranhe o móvel.
 - 2- Ter as ferramentas necessárias como: parafusadeira, chave de fenda, etc.
 - 3- Abrir as caixas e conferir as peças conforme está no manual.
 - 4- Fazer a separação das peças como indicado na imagem.
 - 5- Começa pela base pelas partes menores seguindo as etapas descritas no manual.
 - 6- Montar o roupeiro deitado com a frente para baixo para facilitar o trabalho.
 - 7- As portas e gavetas serão instaladas por último.
 - 8- E por fim verifique se está tudo certo alinhado e fixado corretamente.
- Lembrando que o esquema de montagem varia entre os modelos de roupeiros.
 - É aconselhável pedir ajuda a outra pessoa para te auxiliar na hora de erguer o móvel.

WARDROBE ASSEMBLY INSTRUCTIONS

- 1- Start by preparing the space where the wardrobe will be assembled. Cover the floor so that it does not scratch the furniture.
 - 2- Have the necessary tools such as: screwdriver, screwdriver, etc.
 - 3- Open the boxes and check the parts as shown in the manual.
 - 4- Separate the parts as shown in the image.
 - 5- Start at the base with the smallest parts following the steps described in the manual.
 - 6- Assemble the wardrobe lying face down to make the work easier.
 - 7- The doors and drawers will be installed last.
 - 8- And finally check that everything is aligned and correctly fixed.
- Remember that the assembly scheme varies between wardrobe models.
 - It is advisable to ask another person to help you when lifting the furniture.







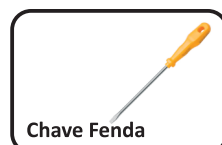
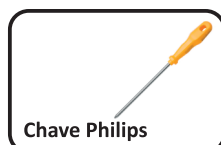



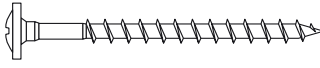
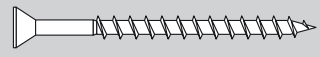
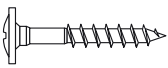
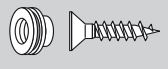
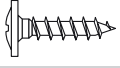
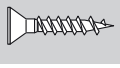

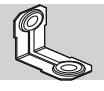

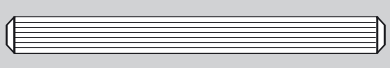

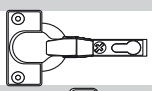
INSTRUCCIONES DE MONTAJE DEL ARMARIO

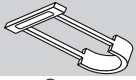
- 1- Prepare el espacio donde se montará el armario. Cubra el suelo para que no raye el mueble.
 - 2- Dispóngase de las herramientas necesarias, como destornillador, destornillador, etc.
 - 3- Abra las cajas y revise las piezas como se indica en el manual.
 - 4- Separe las piezas como se muestra en la imagen.
 - 5- Comience por la base con las piezas más pequeñas siguiendo los pasos descritos en el manual.
 - 6- Monte el armario boca abajo para facilitar el trabajo.
 - 7- Las puertas y los cajones se instalarán en último lugar.
 - 8- Por último, compruebe que todo esté alineado y correctamente fijado.
- Recuerde que el esquema de montaje varía según el modelo de armario.
 - Se recomienda pedir ayuda a otra persona para levantar el mueble.

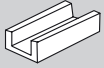
MATERIAL PARA MONTAGEM | ASSEMBLY MATERIAL | MATERIAL PARA ARMADO

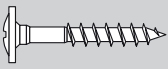
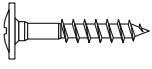

FERRAGEM | HARDWARE | HERRAJES

A	PARAFUSO FLANGEADO 3,5x40 FLANGE SCREW 3,5x40 TORNILLO FLANGEADO 3,5x40		51
B	PARAFUSO 3,5x40 SCREW 3,5x40 TORNILLO FLANGEADO 3,5x40		03
C	PARAFUSO FLANGEADO 3,5x25 FLANGE SCREW 3,5x25 TORNILLO FLANGEADO 3,5x25		16
D	KIT FIXADOR ESPELHO MIRROR FIXING KIT KIT FIJACIÓN ESPEJO		01
E	PARAFUSO FLANGEADO 3,5x12 FLANGE SCREW 3,5x12 TORNILLO FLANGEADO 3,5x12		220
F	PARAFUSO 3,5x16 SCREW 3,5x16 TORNILLO 3,5x16		16
G	FIXADOR FIXER FIJADOR		20
H	CANTONEIRA 18x18 15x15 CORNER ESQUINA 15x15		20
I	CAVILHA 6x30 6x30 PEGS TACOS 6x30		19
J	CAVILHA 6x50 6x50 PEGS TACOS 6x50		03
K	PREGO 10x10 C/C NAIL 10x10 CLAVO 10x10		152
L	PREGO 13x15 C/C NAIL 13x15 CLAVO 13x15		16
M	DOBRADIÇA HINGE BISAGRA		32
N	CALÇO DOBRADIÇA HINGE MOUNTING PLATE BASE DE BISAGRA		32
O	SUPORE CABIDEIRO HANGER SUPPORT APOYO PERCHERO		02
P	SUPORE CENTRAL CENTER SUPPORT APOYO CENTRAL		01
Q	DISTANCIADOR 32mm 32mm DISTANCER DISTANCIADOR 32mm		16
R	SAPATA SHOE ZAPATA		10
S	SUPORE PRATELEIRA SHELF SUPPORT SOPORTE ESTANTE		16
T	COLA GLUES PEGAMENTO		01
U	CABIDEIRO HANGER PERCHERO		01
V	PUXADOR HANDLE TIRADOR		08
W	CORREDIÇA SLIDER CORREDIZA		04
X	PARAFUSO 3,5x25 FLANGEADO (RIPADO) 3,5x25 FLANGE SCREW (SLATTED) TORNILLO 3,5x25 FLANGEADO (RANURADO)		24
Z	PARAFUSO FLANGEADO 3,5x20 FLANGE SCREW 3,5x20 TORNILLO FLANGEADO 3,5x20		02



UTILIZE A RÉGUA PARA A MEDIÇÃO DOS PARAFUSOS | USE THE RULER TO MEASURE THE SCREWS | USA LA REGLA PARA MEDIR LOS TORNILLOS

Preparando a Lateral Esquerda.

Preparing Left Side.

Preparante Lateral Izquierda.

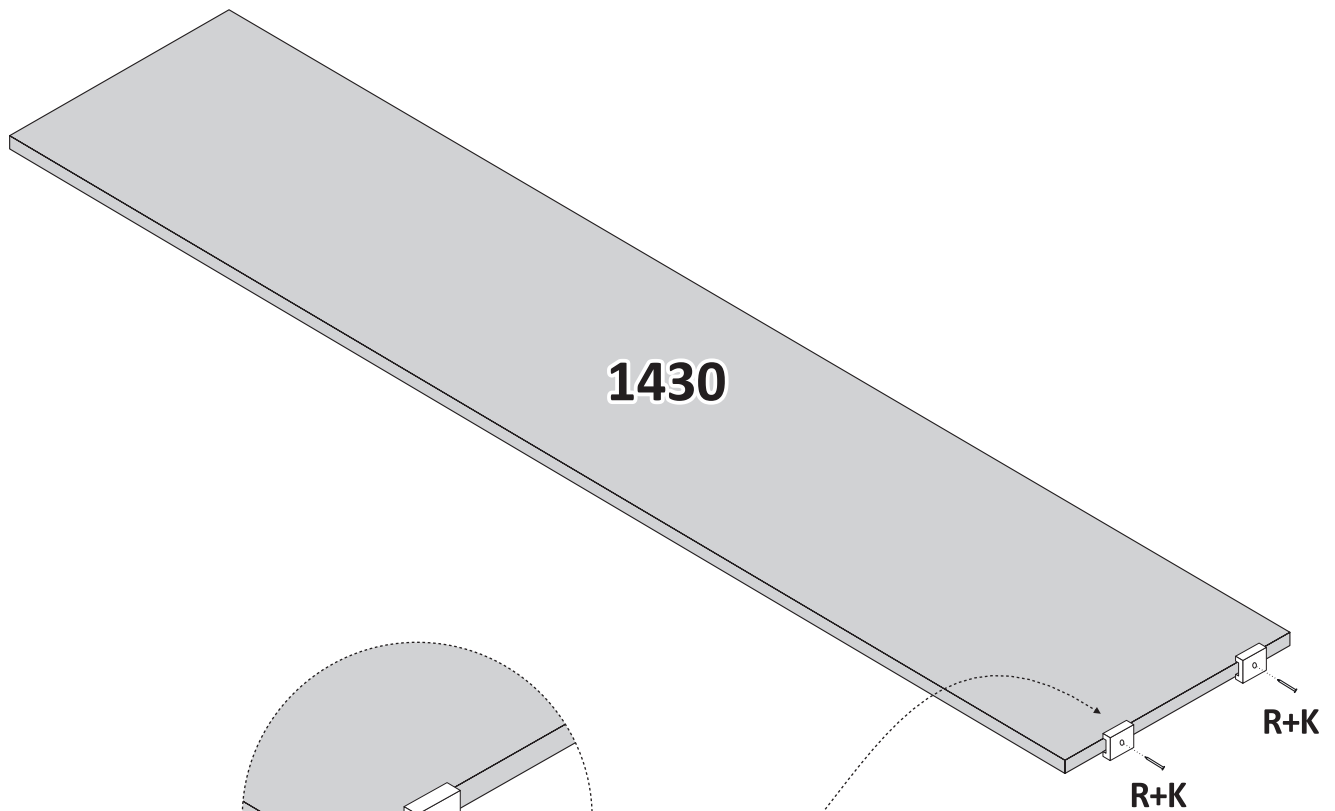

COLOCAÇÃO DAS SAPATAS.

putting on the shoes.
poniéndose los zapatos.

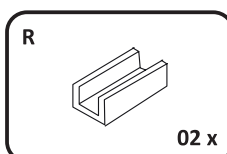
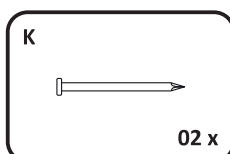

Preparando a Lateral Direita.

Preparing Right Side.

Preparante Lateral Derecha.

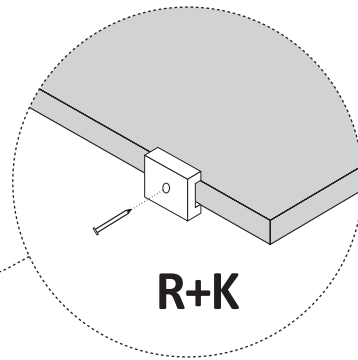
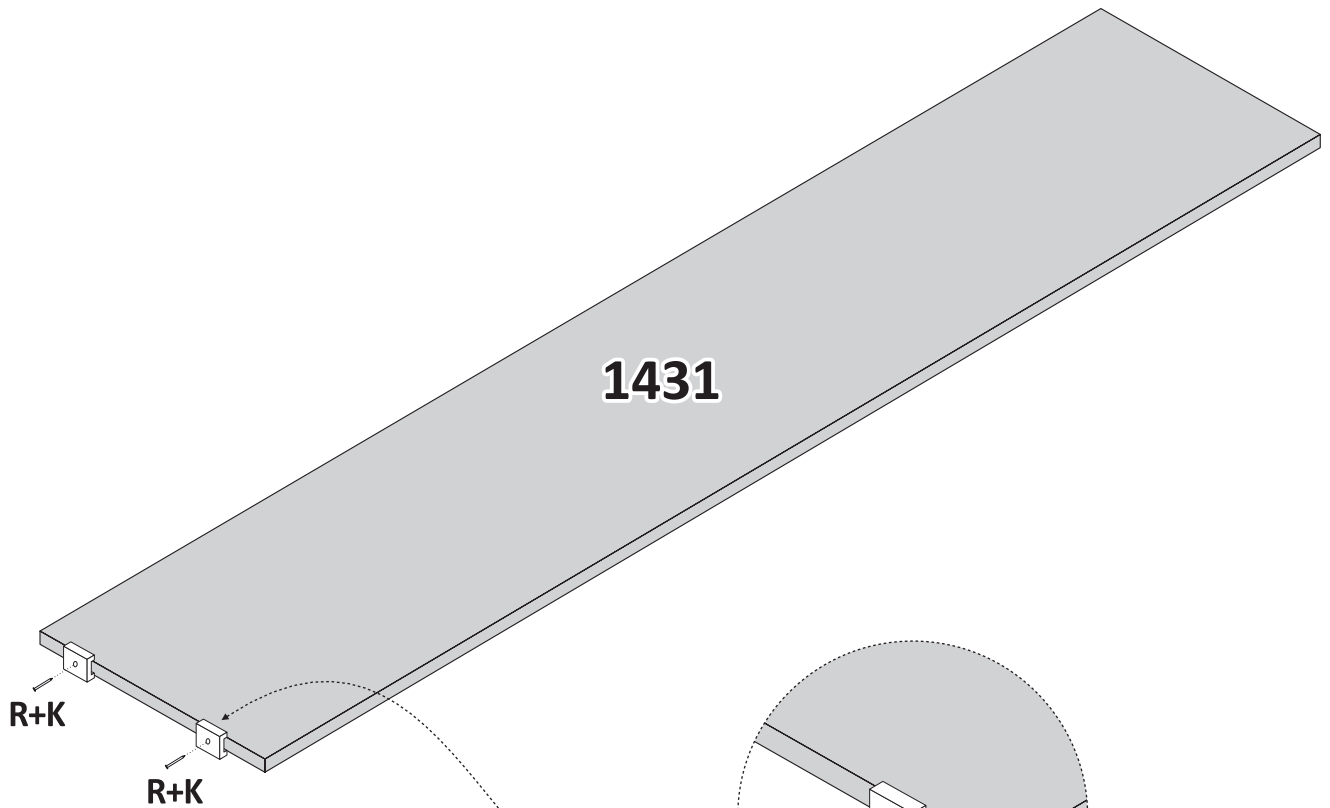

COLOCAÇÃO DAS SAPATAS.

putting on the shoes.

poniéndose los zapatos.

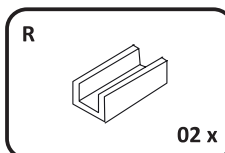
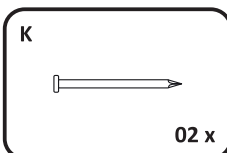

Montando Lateral Esquerda.

Assembly Left Side.

Montaje Lateral Izquierda.

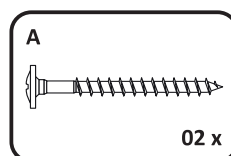
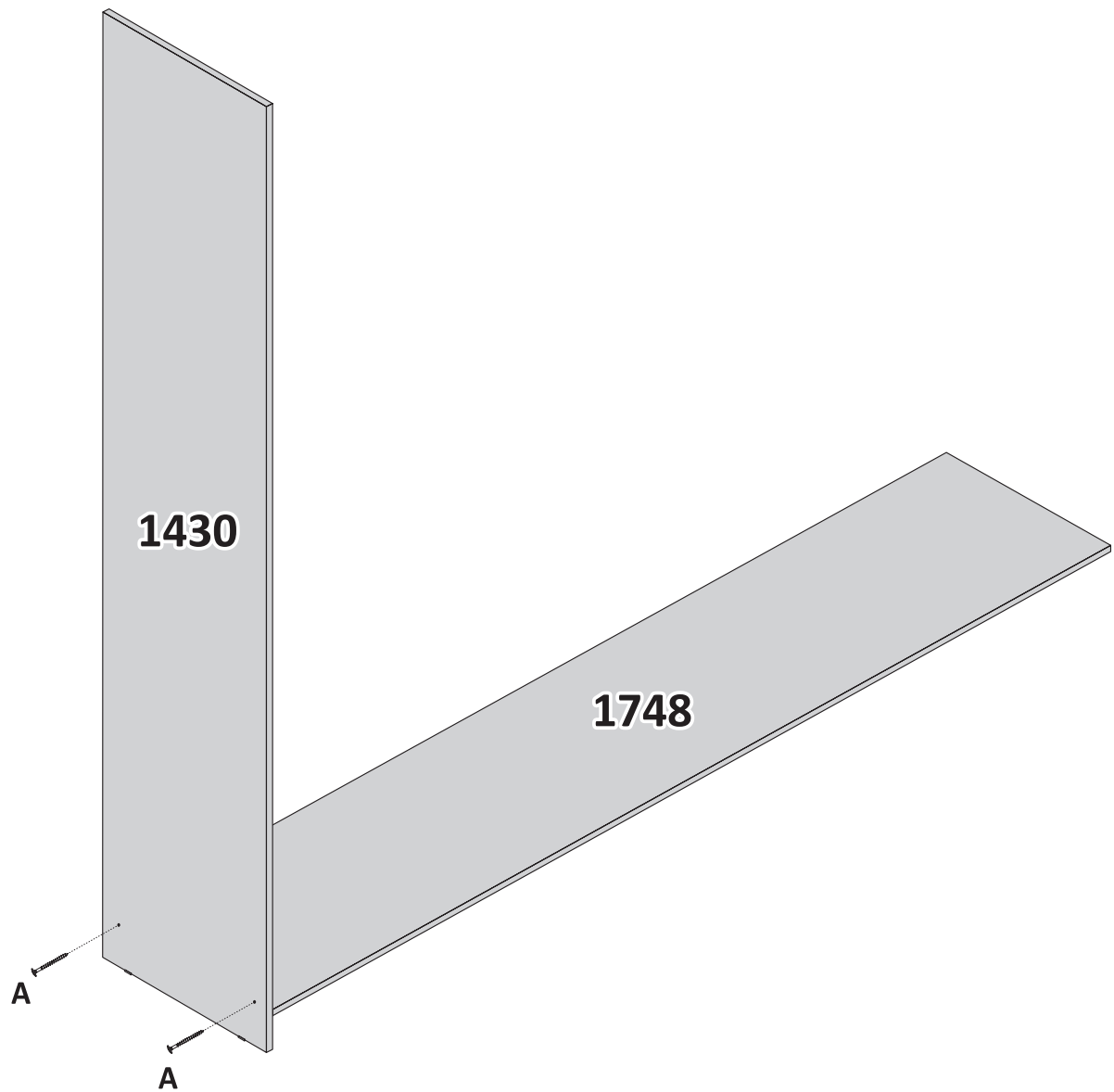

Montando Lateral Direita.

Assembly Right Side.

Montaje Lateral Derecha.

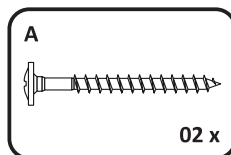
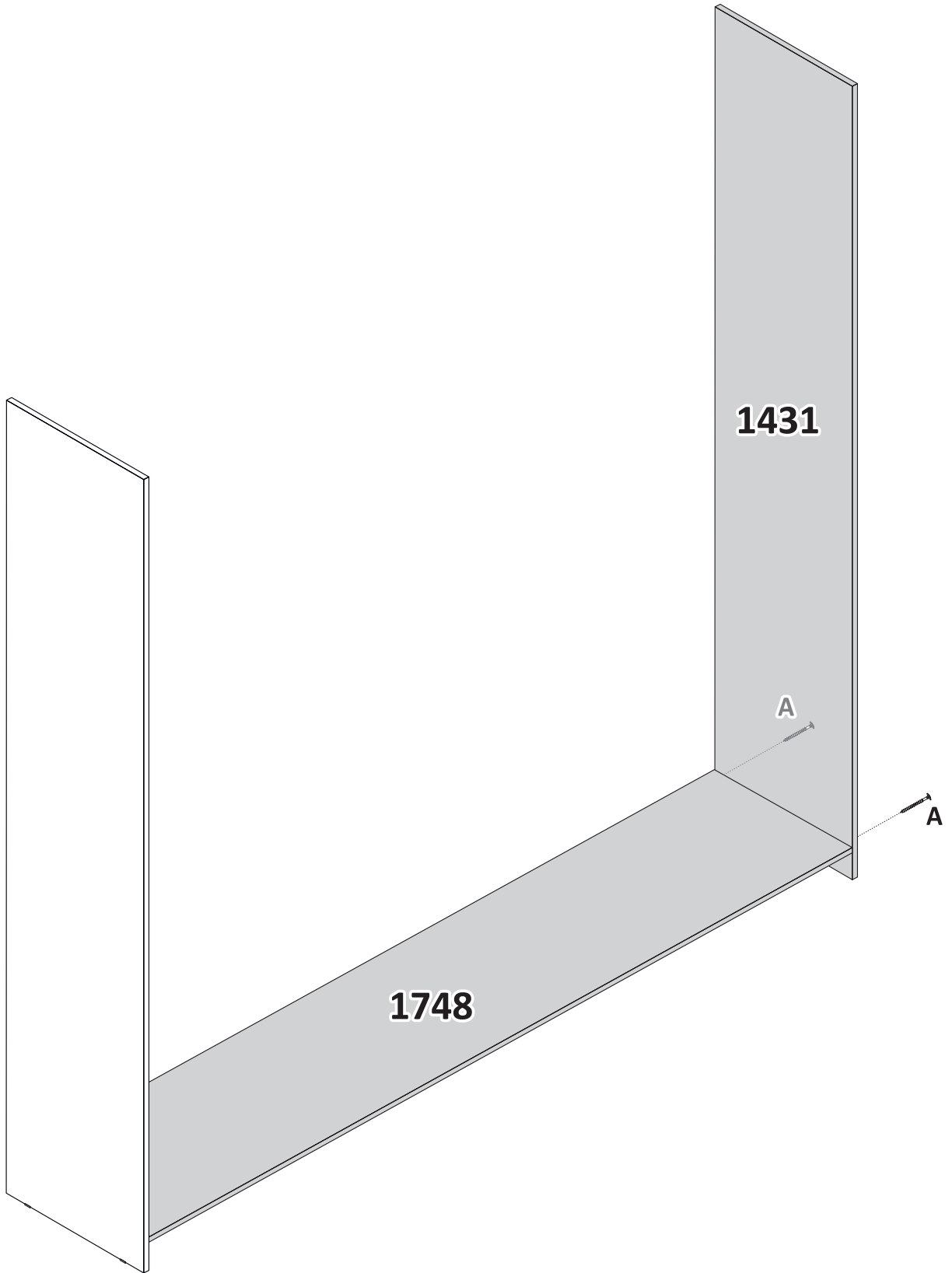

Preparando a Divisão Direita.

Preparing Right Divider.

Preparante División Derecha.

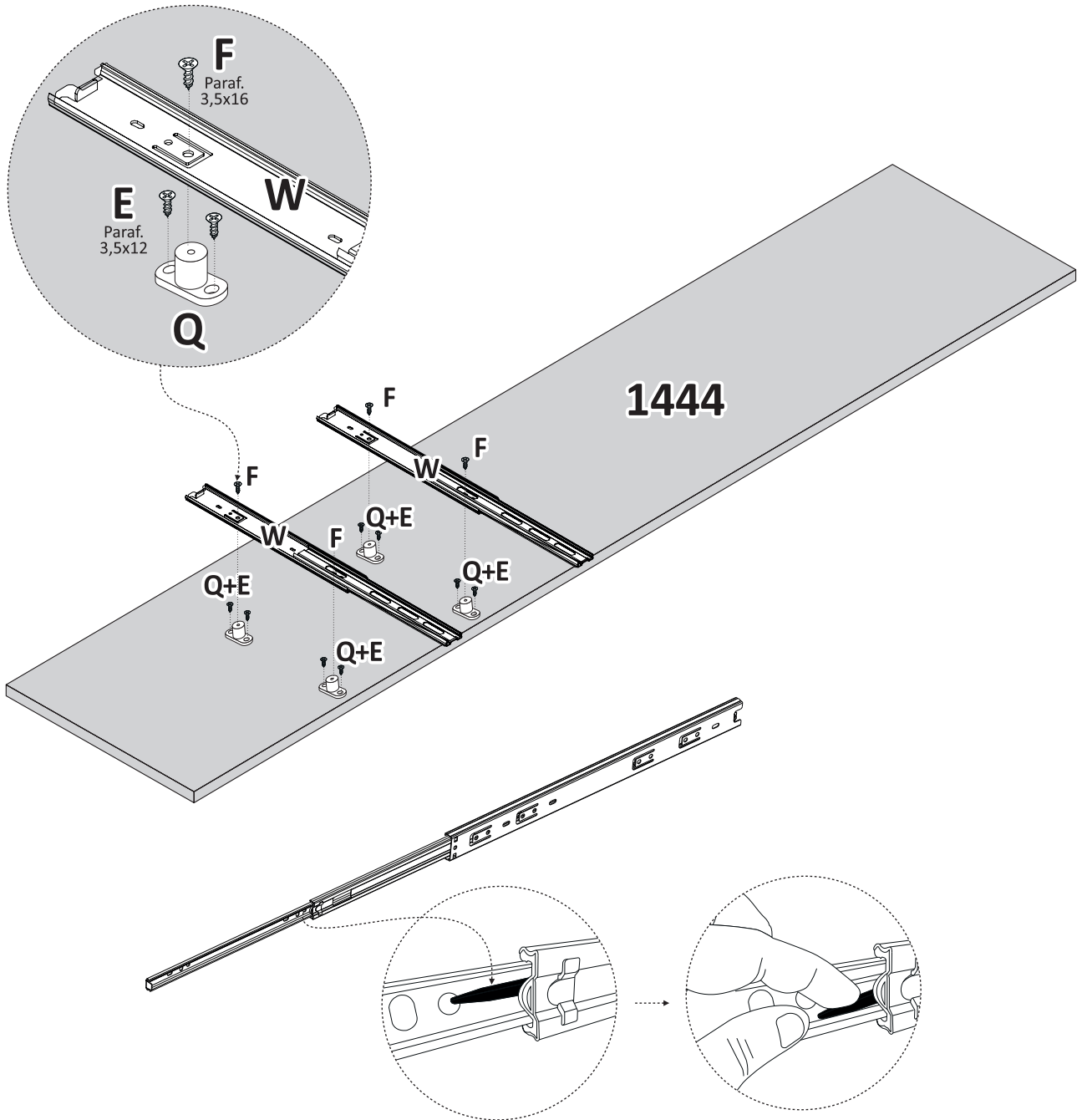

ABAIXE A TRAVA PRETA E RETIRE A PEÇA CONFORME DESENHO ABAIXO.

LOWER THE BLACK LATCH AND REMOVE THE PART AS SHOWN IN THE DRAWING BELOW.

BAJE EL SEGURO NEGRO Y RETIRE LA PIEZA SEGÚN EL DIBUJO DE ABAJO.

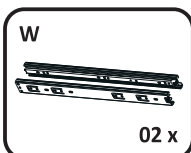
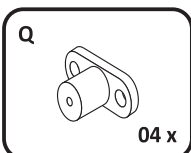
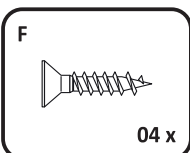
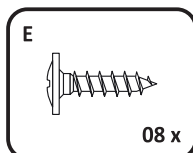

Preparando a Divisão Esquerda.

Preparing Left Divider.

Preparante División Izquierda.

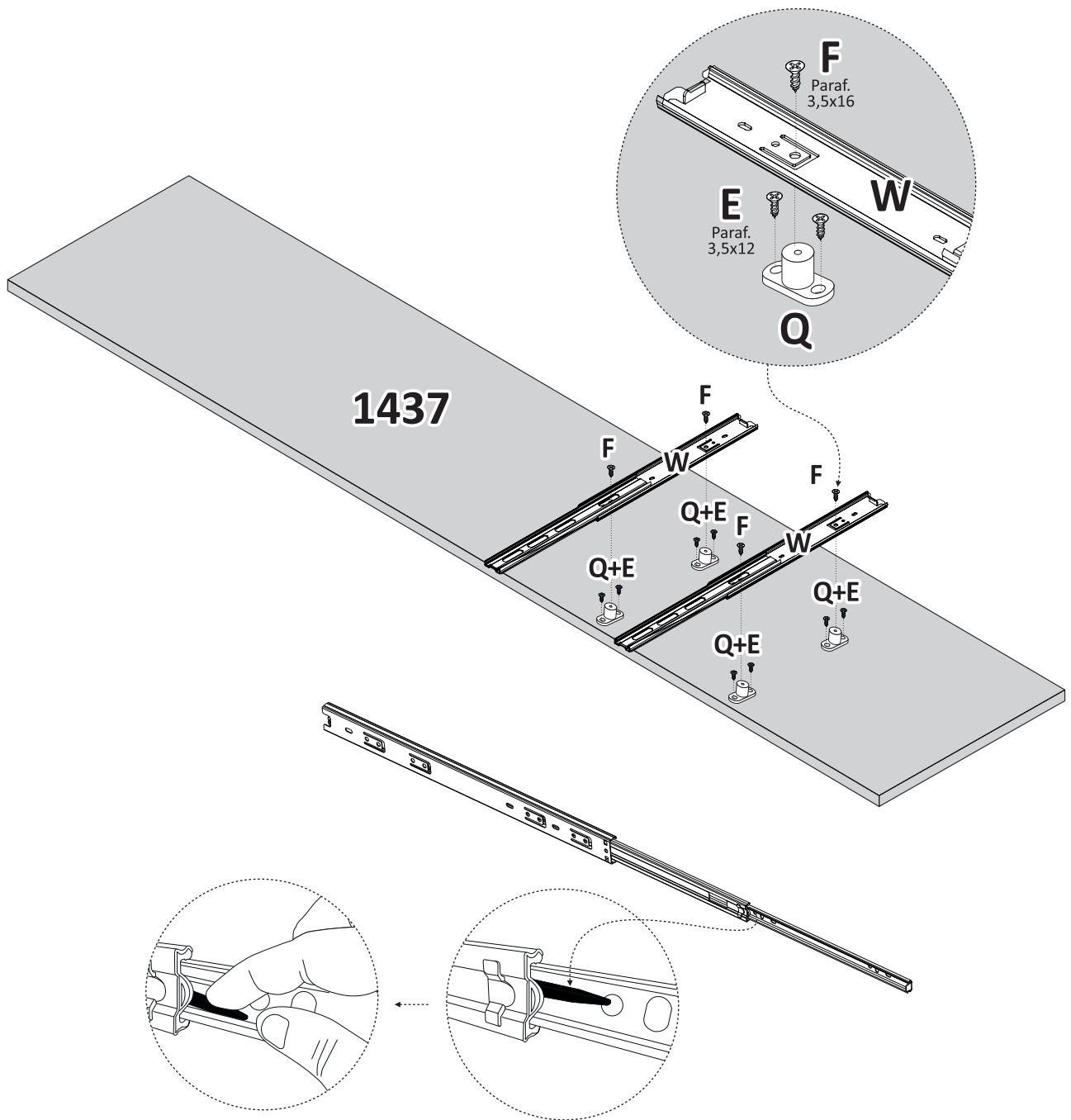

ABAIXE A TRAVA PRETA E RETIRE A PEÇA CONFORME DESENHO ABAIXO.
LOWER THE BLACK LATCH AND REMOVE THE PART AS SHOWN IN THE DRAWING BELOW.
BAJE EL SEGURO NEGRO Y RETIRE LA PIEZA SEGÚN EL DIBUJO DE ABAJO.

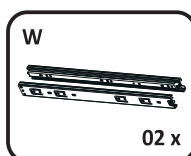
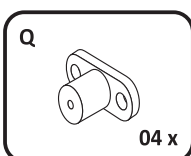
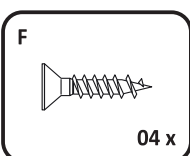
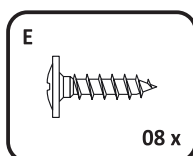

Preparando a Divisão Central.

Preparing Central Divider.

Preparante División Central.

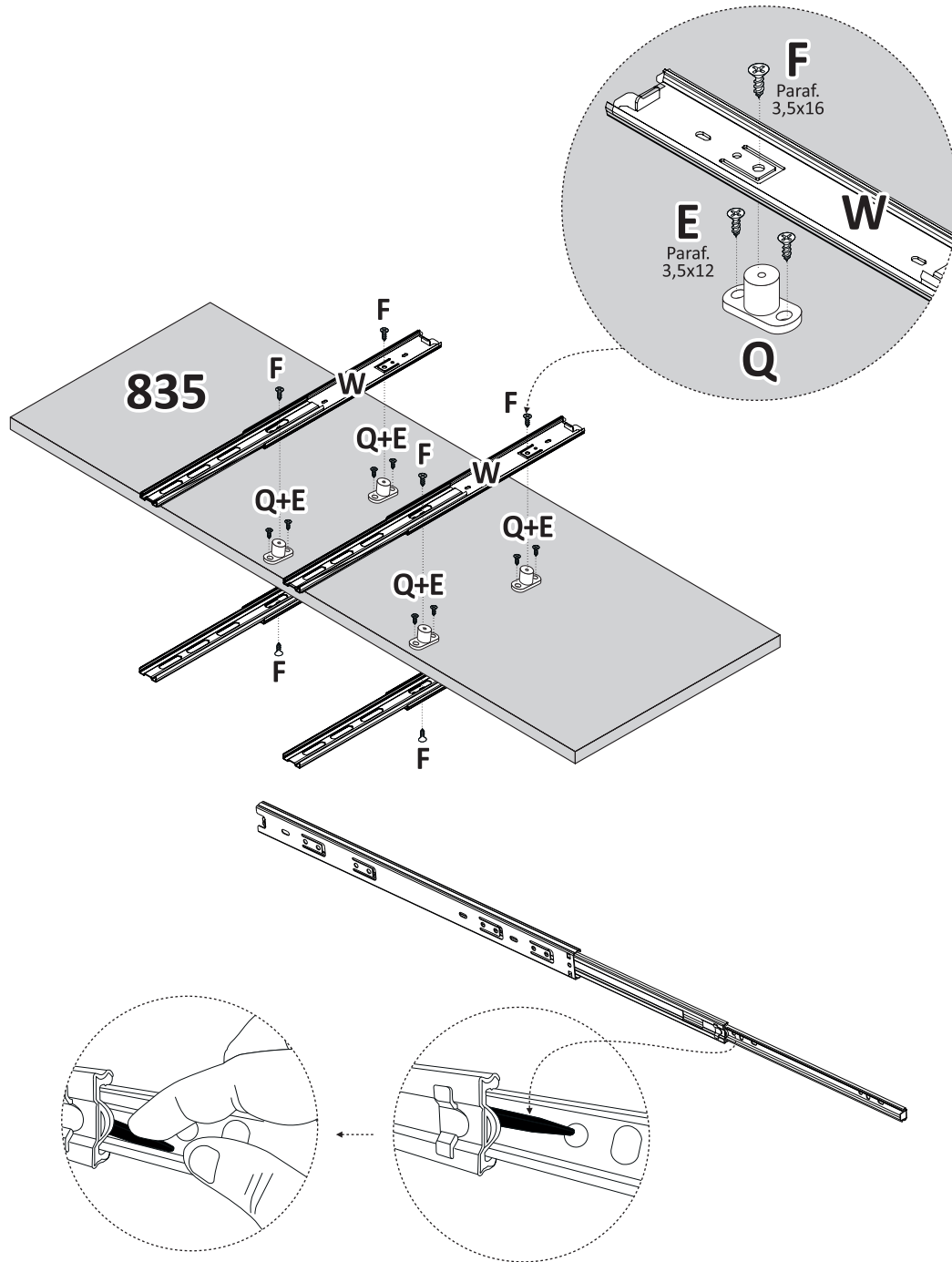

ABAIXE A TRAVA PRETA E RETIRE A PEÇA CONFORME DESENHO ABAIXO.
 LOWER THE BLACK LATCH AND REMOVE THE PART AS SHOWN IN THE DRAWING BELOW.
 BAJE EL SEGURO NEGRO Y RETIRE LA PIEZA SEGÚN EL DIBUJO DE ABAJO.

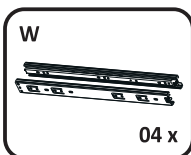
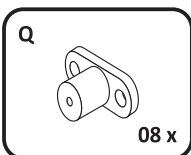
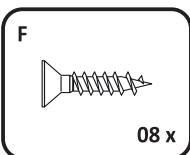
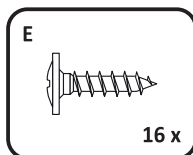

Montar as Divisões.

Assembly Divider.
Montaje División.

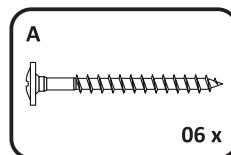
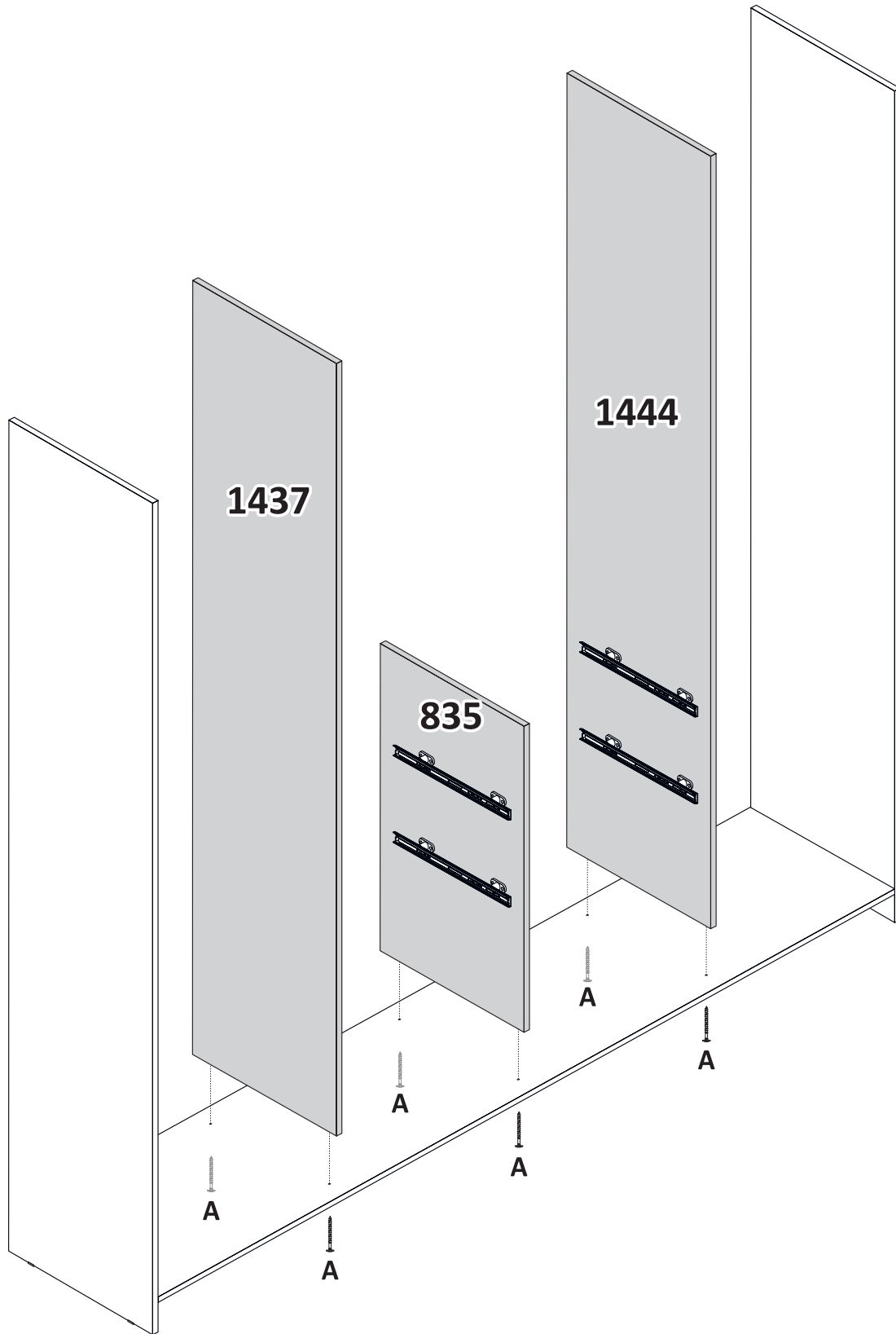

Montar Rodapé.

Assembly Baseboard.
Montaje Zócalo.

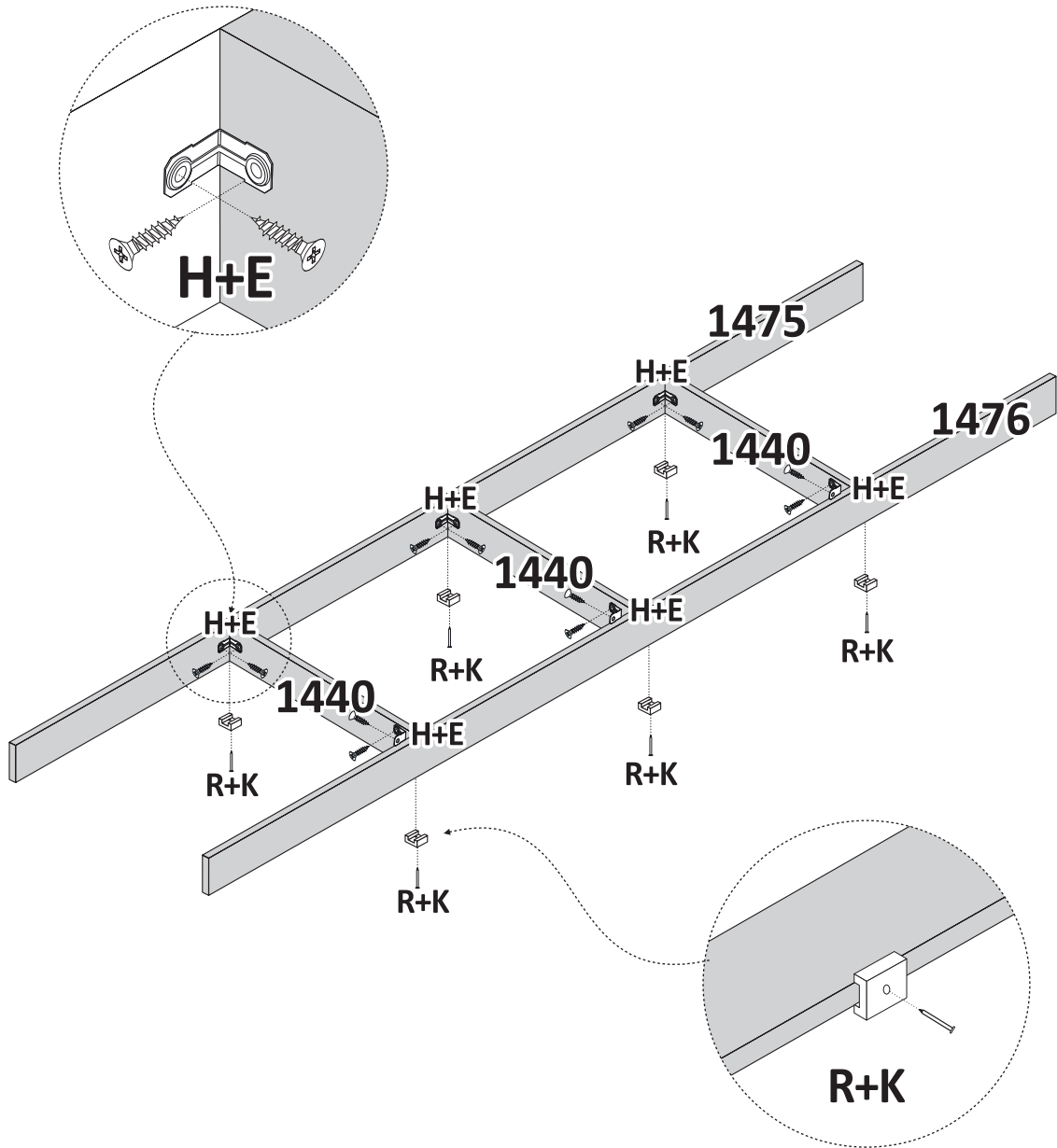

COLOCAÇÃO DAS SAPATAS.

putting on the shoes.
poniéndose los zapatos.

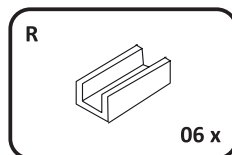
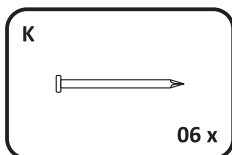
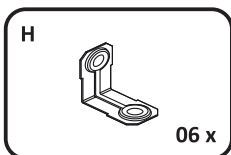
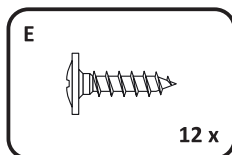

Montar Rodapé.
Assembly Baseboard.
Montaje Zócalo.

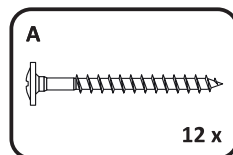
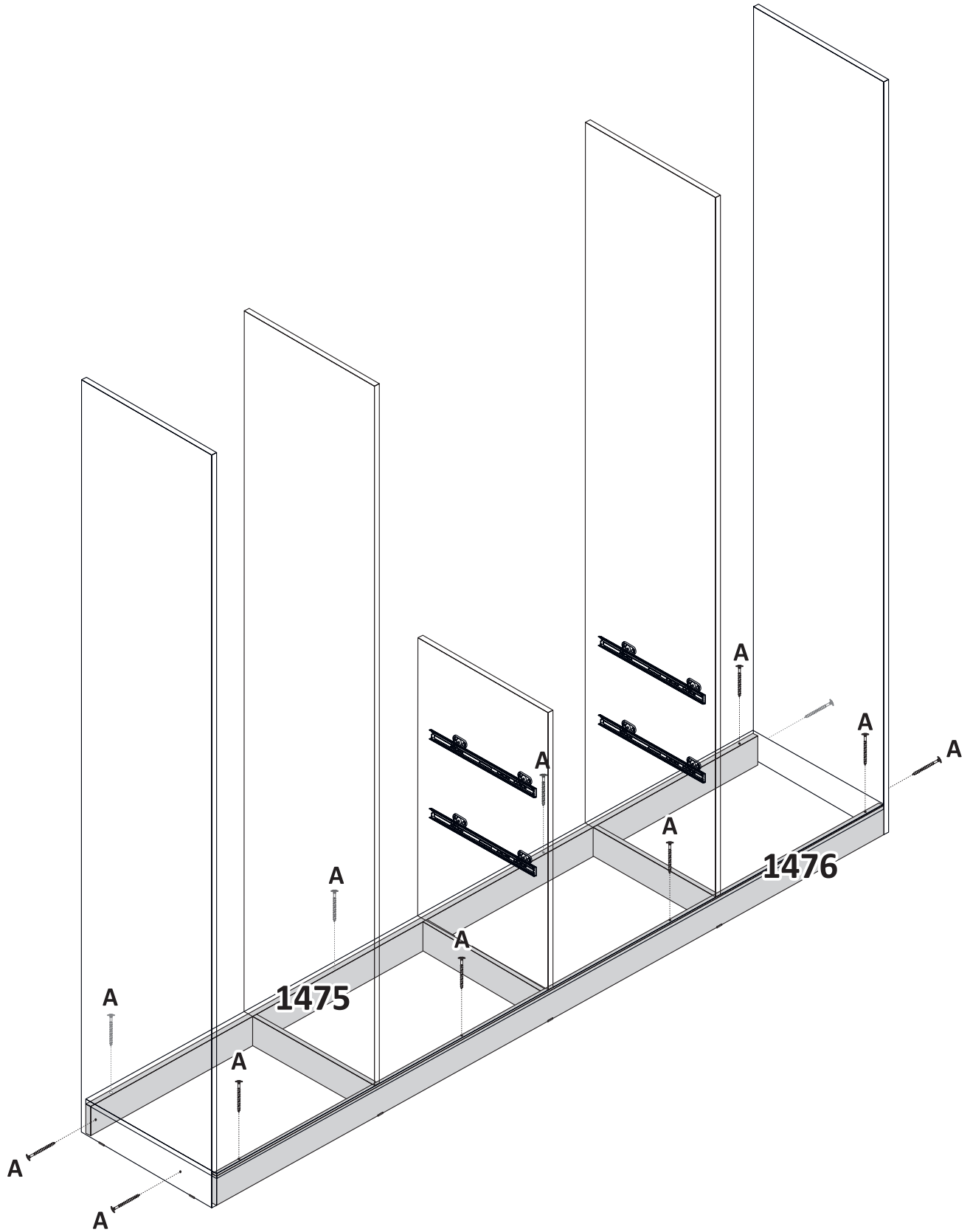

Preparando Tampo Central.

Preparing Central Panel.
Preparando Tapa Central

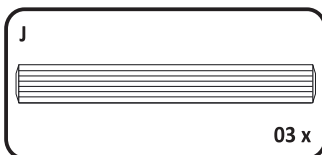
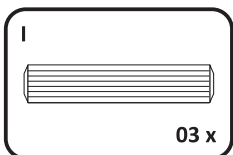
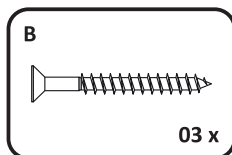
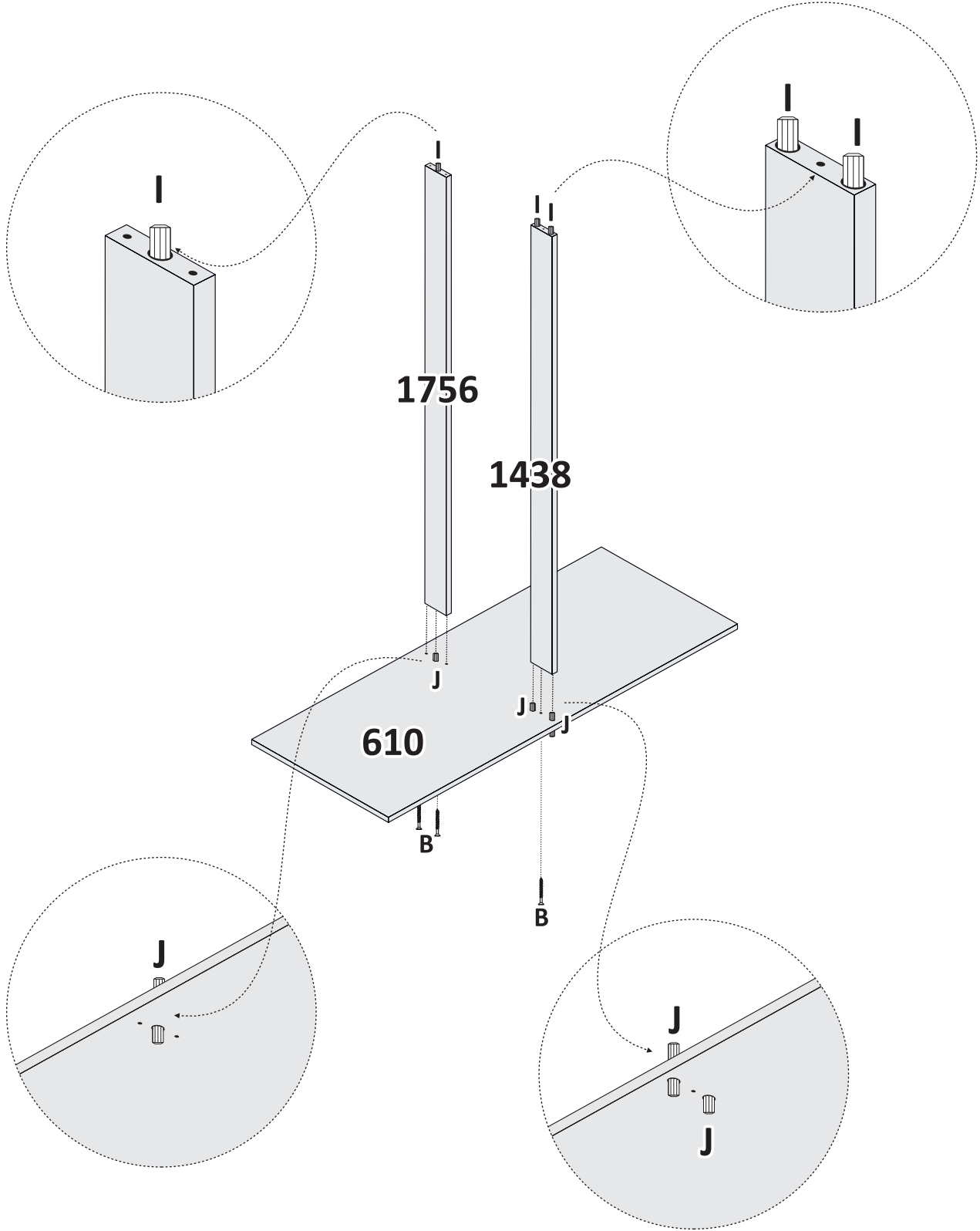

Montando Tampo Central.

Assembly Central Panel.
Montaje Tapa Central.

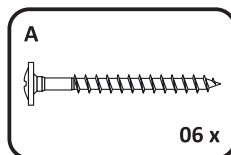
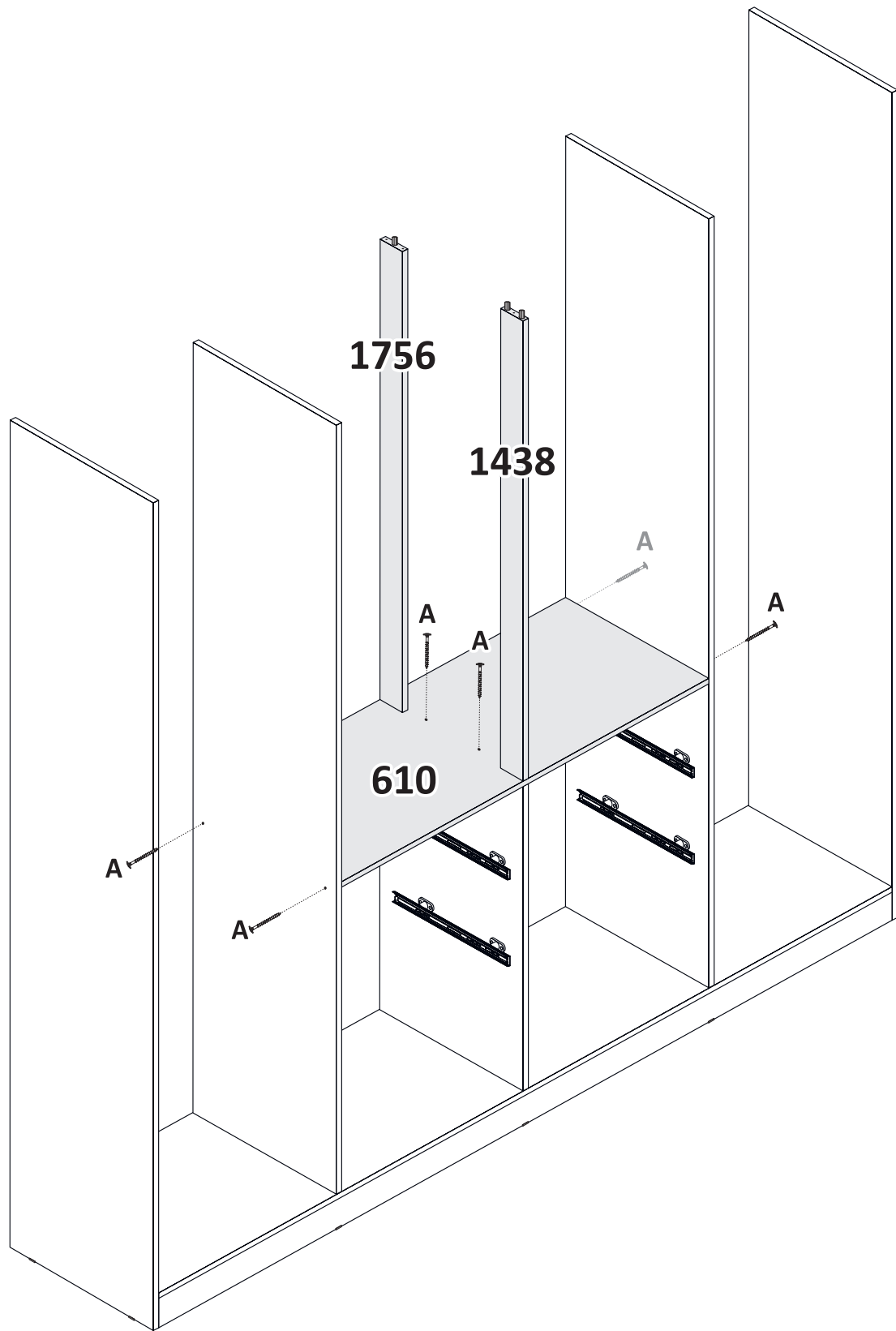

Montando Prateleiras Furadas e Travessas.

Assembling Perforated Shelves and Crossbars.

Montaje de Estantes Perforados y Travesaños.

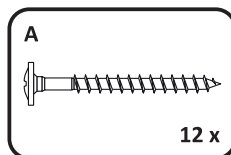
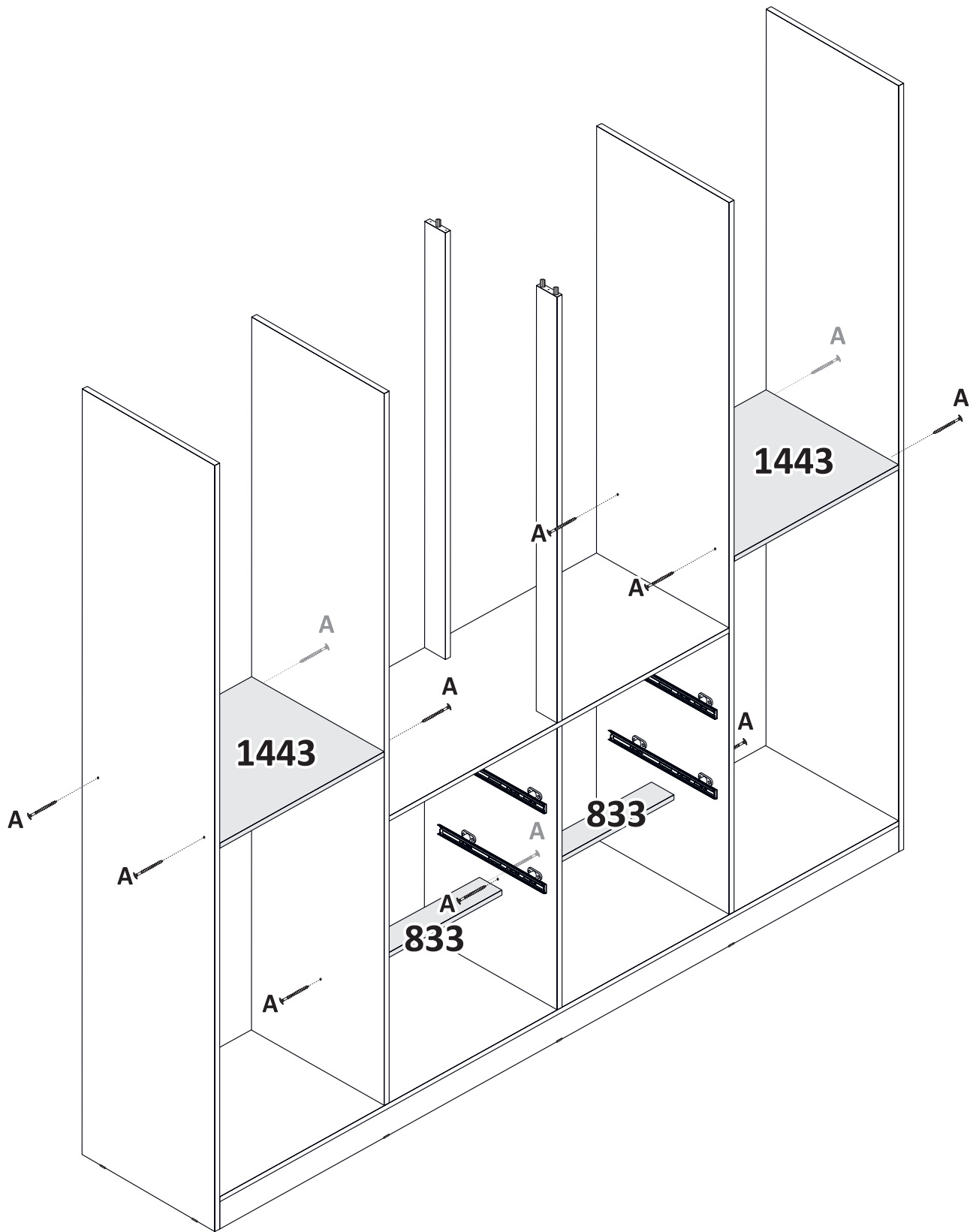

Montagem Tampo.

Hive Top.
Estante Tapa.

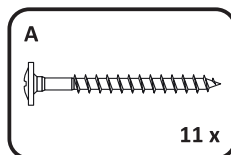
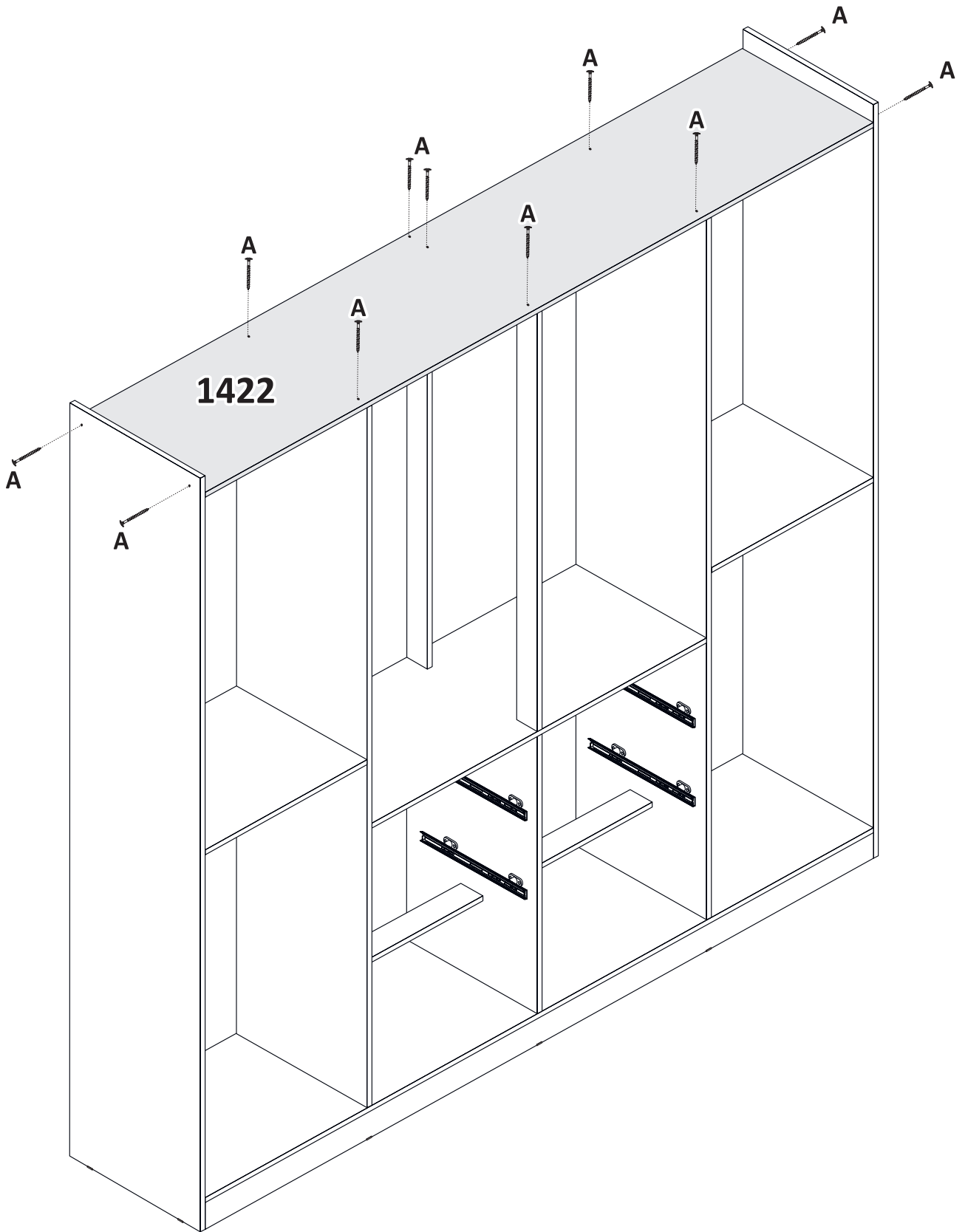

Montagem Rodaforro.

Assembly Rodaforro.
Montaje de Rodaforro.

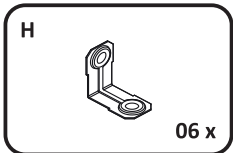
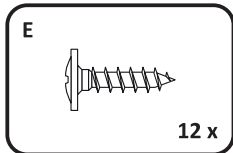
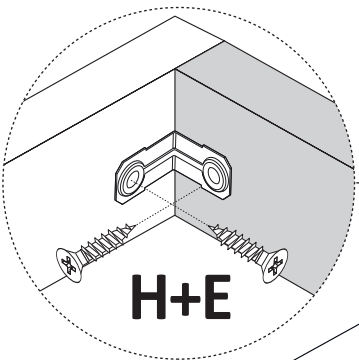
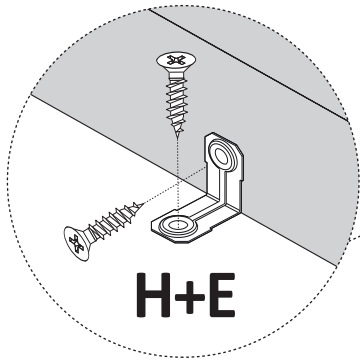
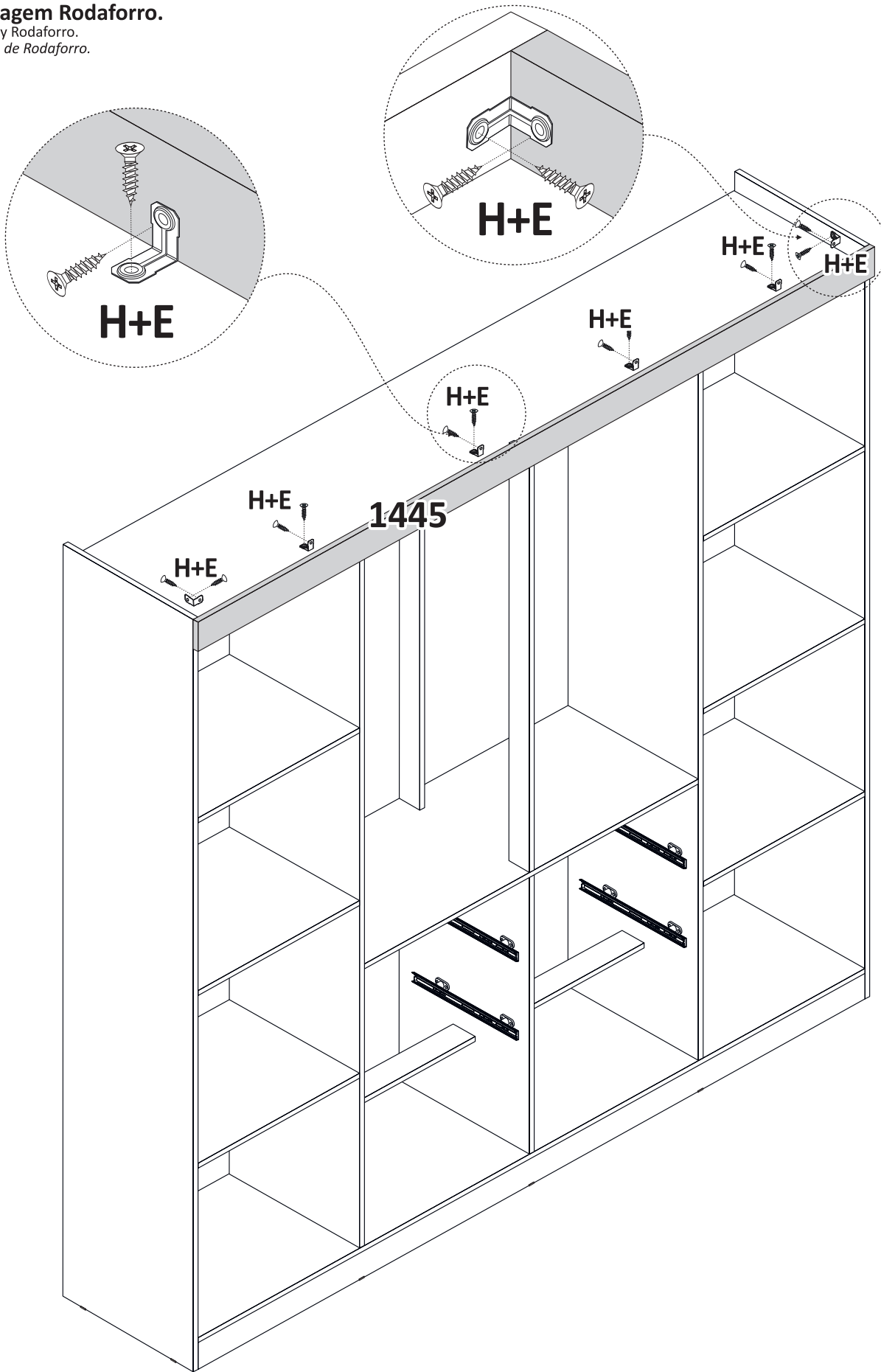

Montagem das Costas.

Back Assembly.
Montaje Trasero.

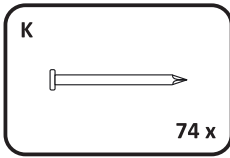
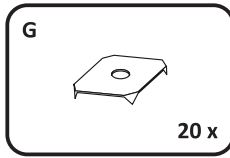
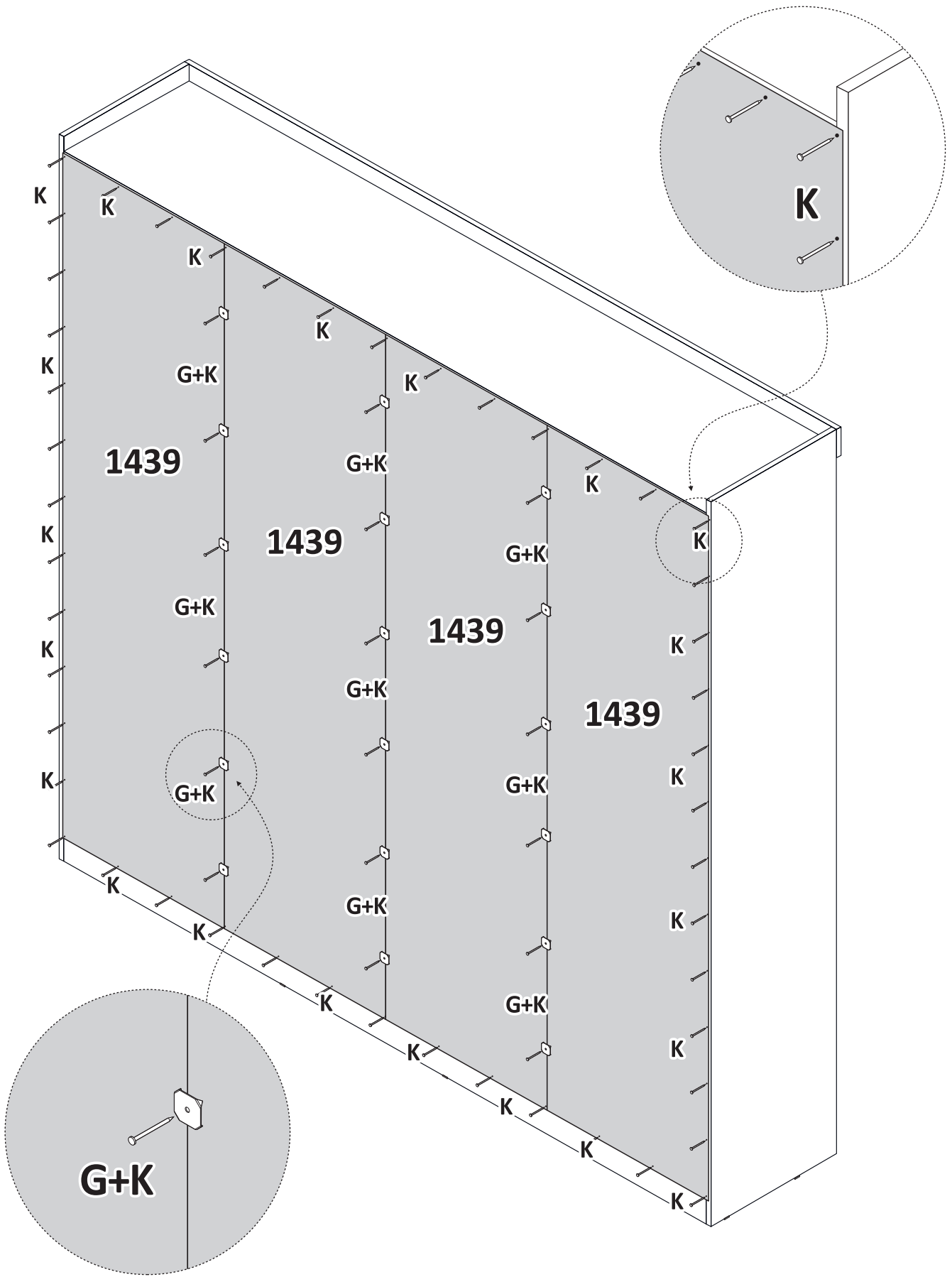

Montar Prateleiras Móveis.

Assemble Mobile Shelves.
Montar Estantes Móveis.

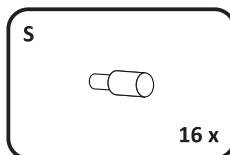
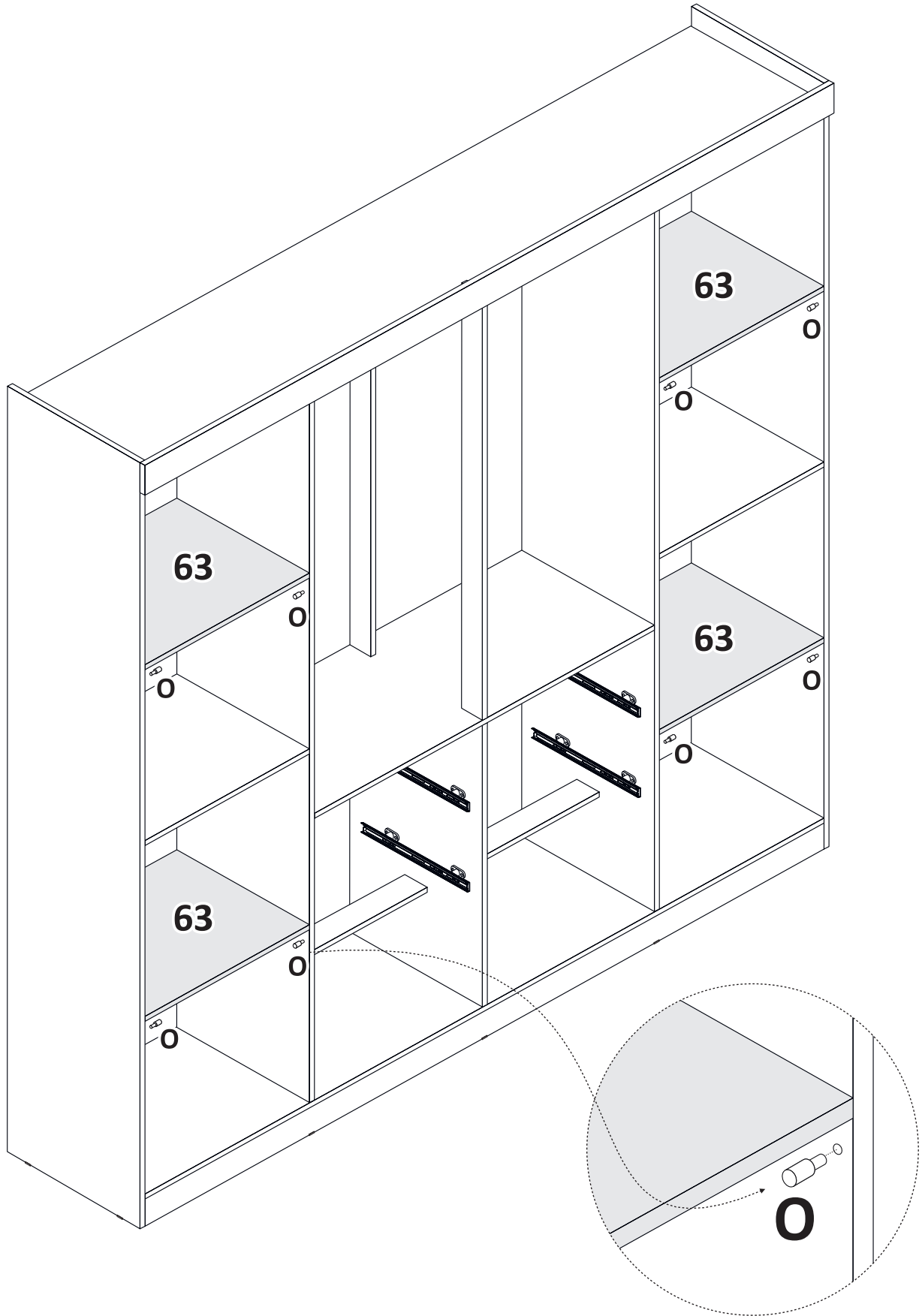

Montar Cabideiro.

Assemble Clothes Rack.
Montar Perchero.

PRIMEIRO MONTAR O SUPORTE CENTRAL, SÓ DEPOIS OS SUPORTES LATERAIS.

FIRST ASSEMBLE THE CENTER SUPPORT, ONLY THEN THE SIDE SUPPORTS.

PRIMERO MONTE EL SOPORTE CENTRAL, SÓ DESPUÉS LOS SOPORTES LATERALES.

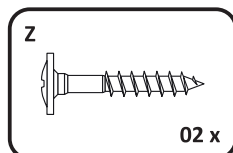
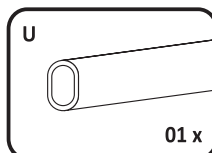
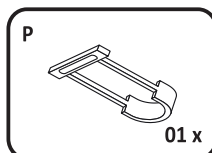
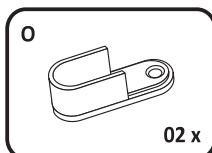
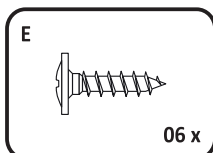
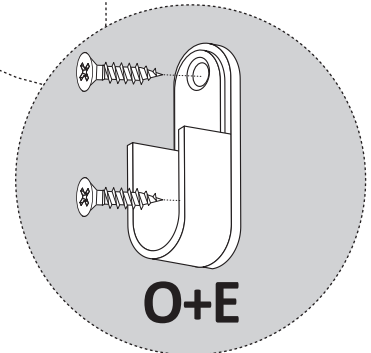
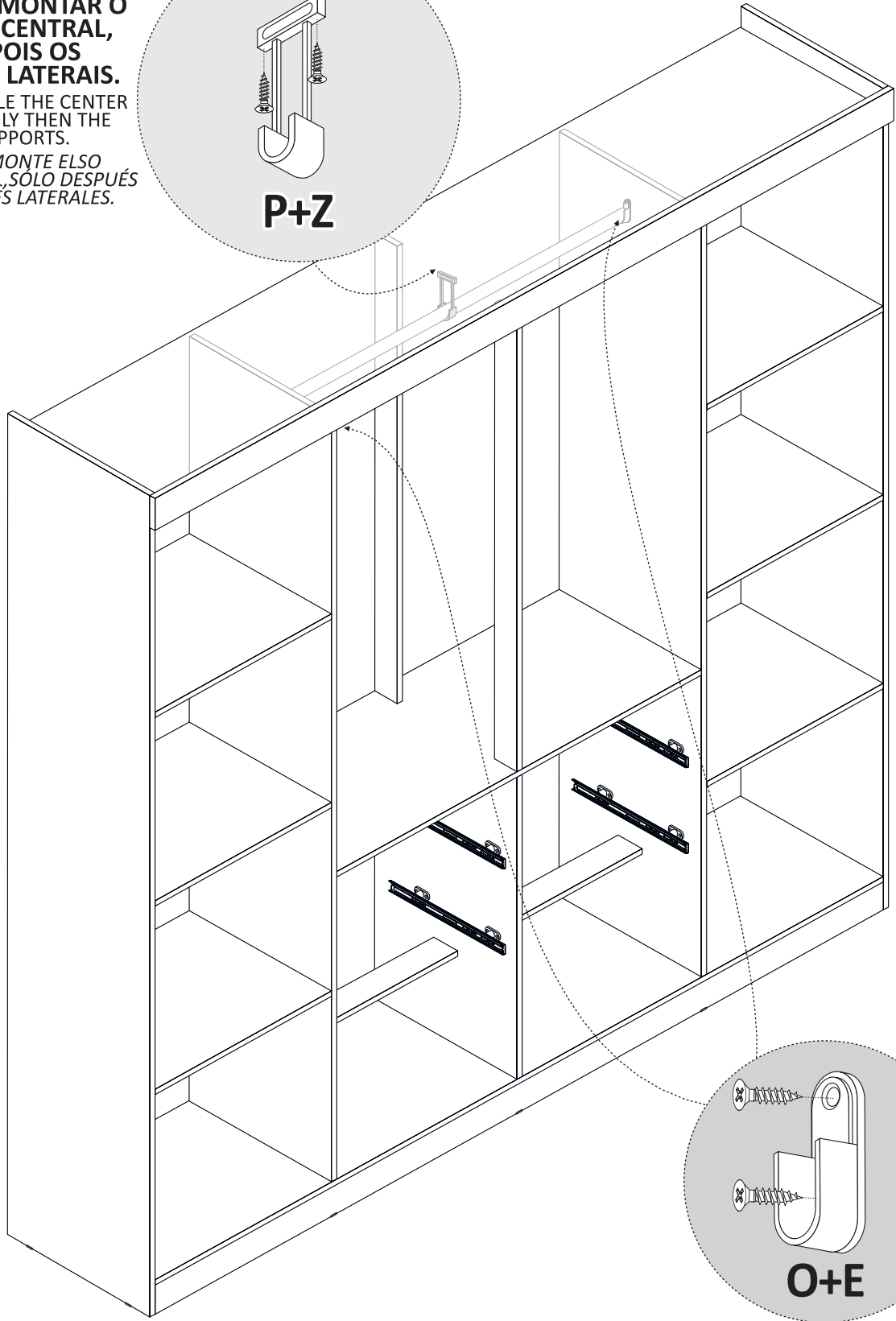
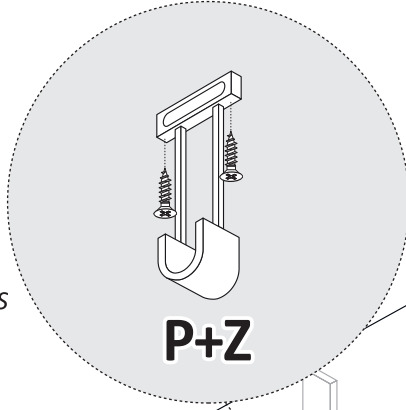

Peso suportado em cada parte.

Weight supported on each part.

Peso soportado en cada parte.

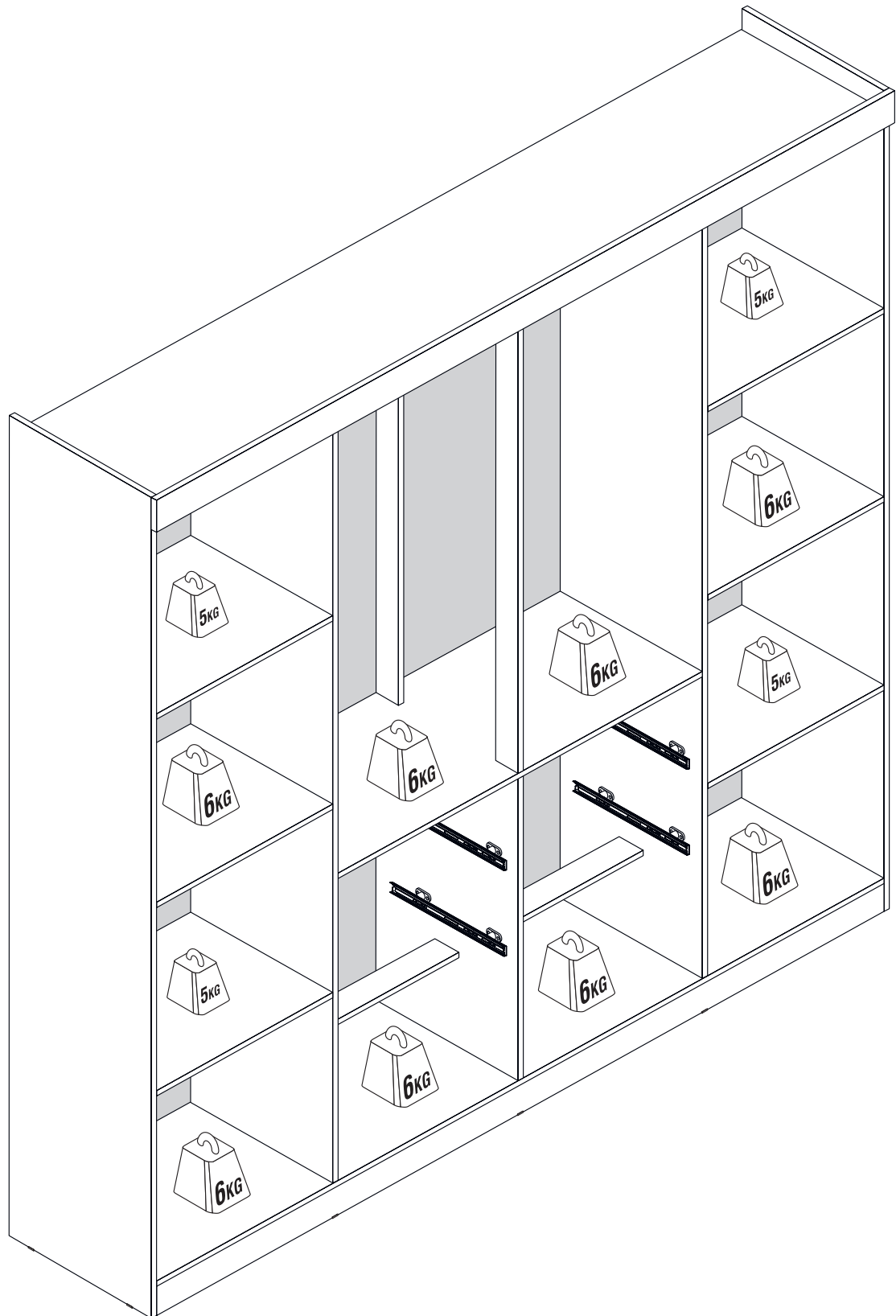

Medidas espaços internos.

Internal spaces measurements.

Medidas del espacios interiores.

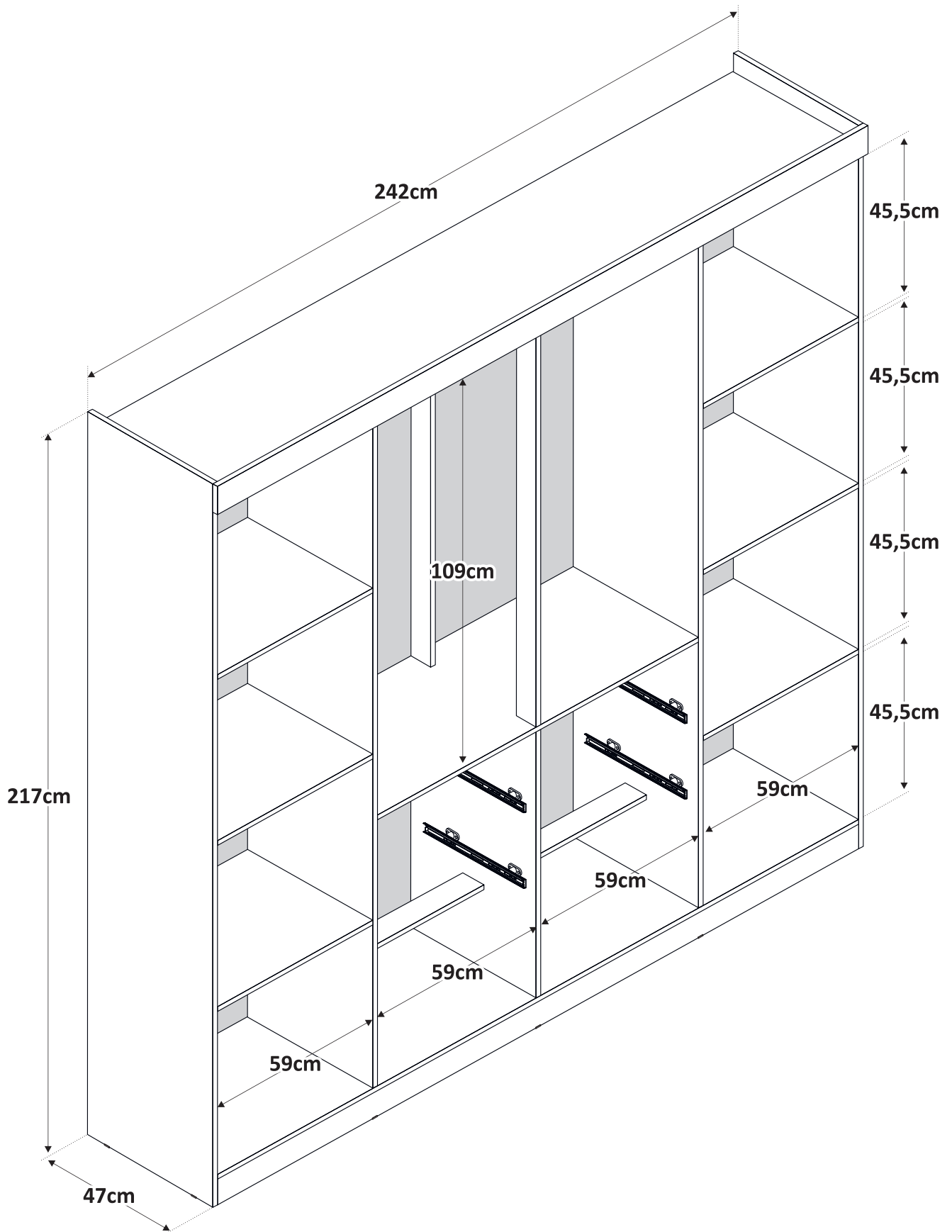

Montagem Porta Esquerda.

Left Door Assembly.

Montaje de la Puerta Izquierda.

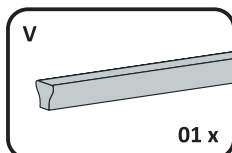
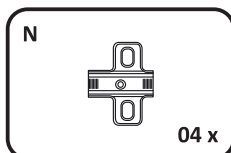
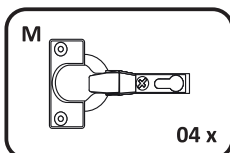
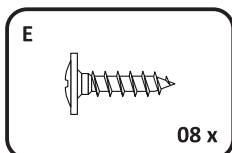
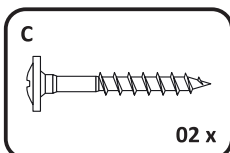
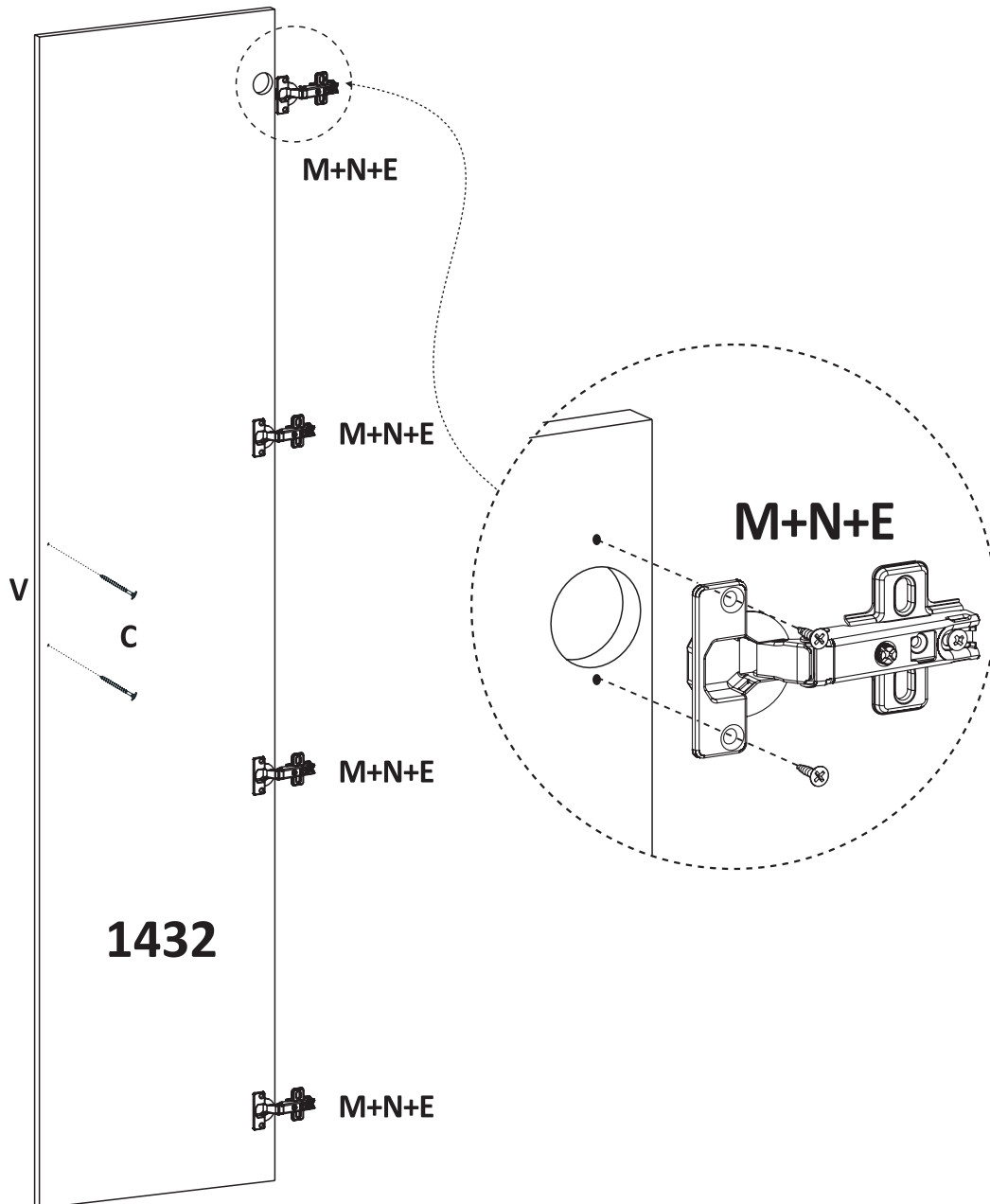

Montagem Porta Direita.

Right Door Assembly.

Montaje de la Puerta Derecha.

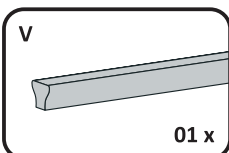
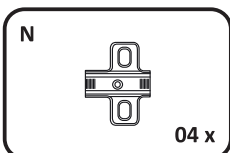
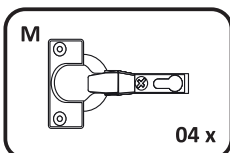
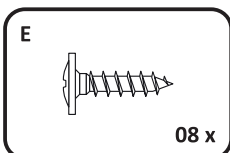
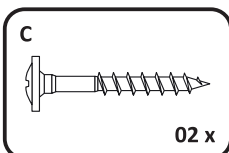
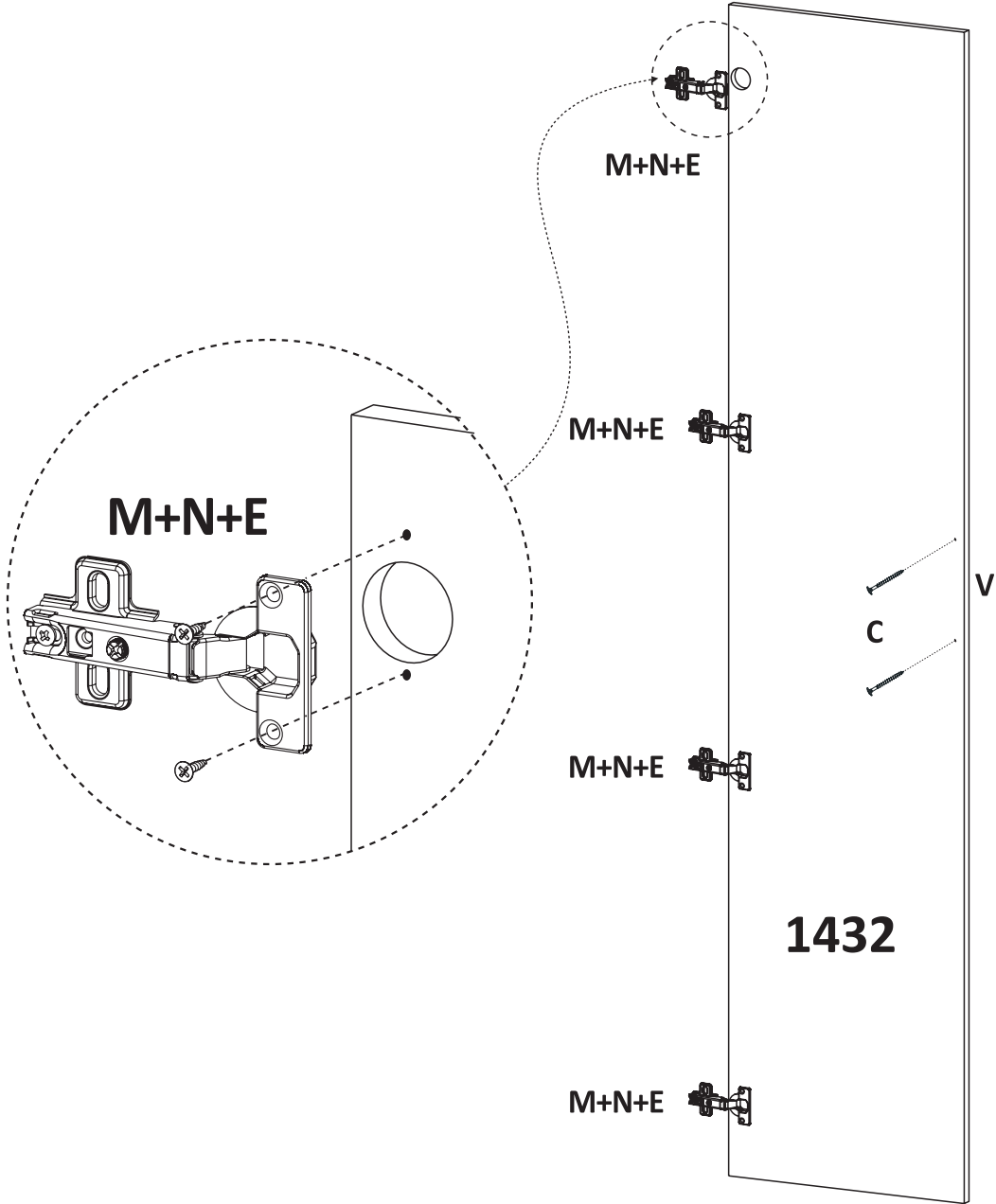

Montagem Kit Espelho Opcional.

Optional Mirror Kit Assembly.
Montaje de Kit Espejo Opcional.

Espelho Opcional.

Optional Mirror
Espejo Opcional.



**NÃO UTILIZAR
PARAFUSADEIRA**

DO NOT USE A SCREWDRIVER
No utilice un destornillador

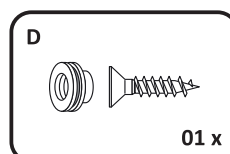
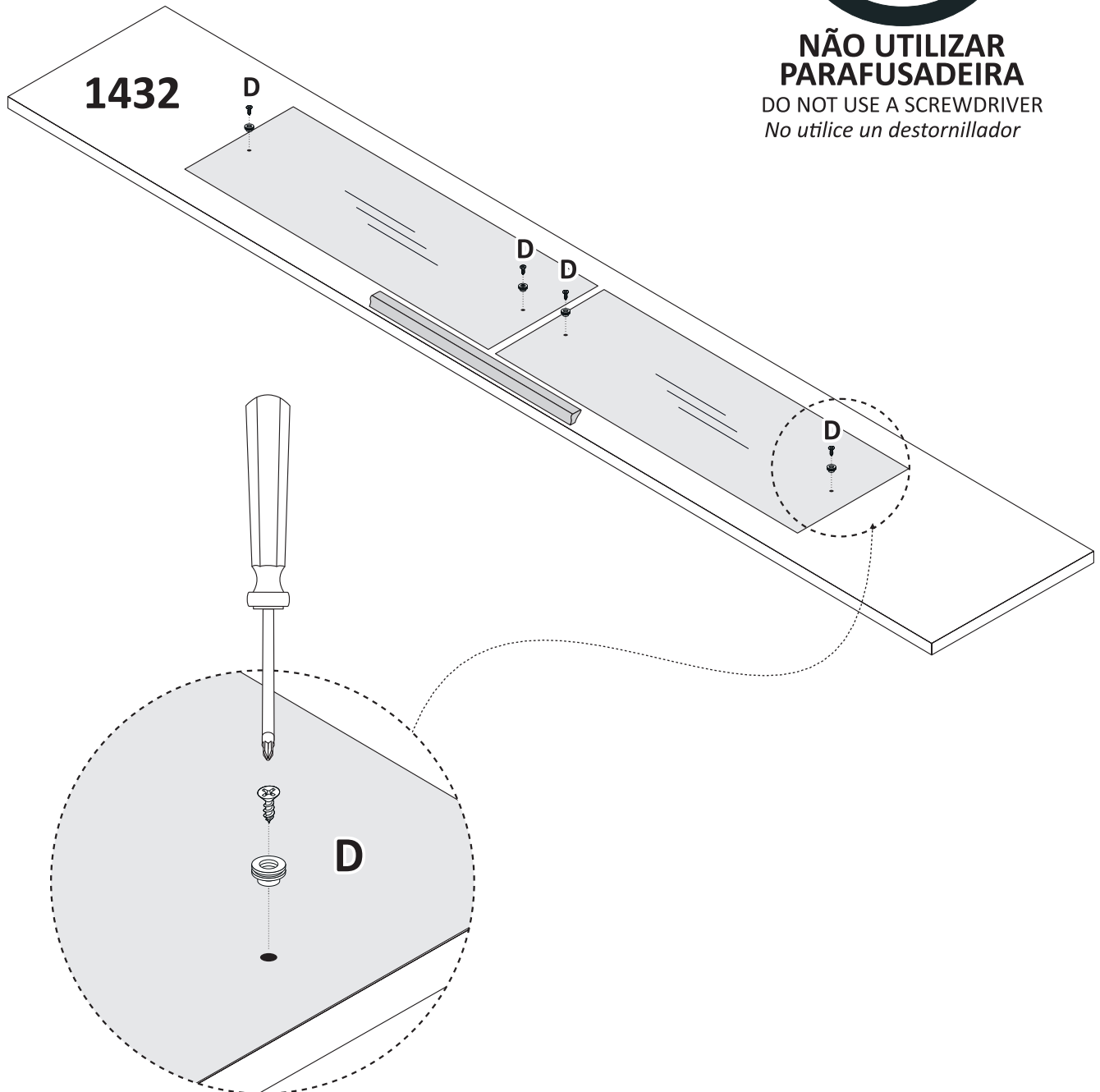

Montagem Porta Reflecta Esquerda.

Left Reflecta Door Assembly.

Montaje de la Puerta Reflecta Izquierda.

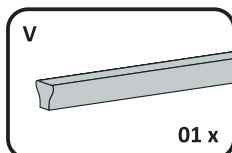
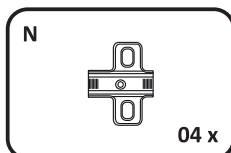
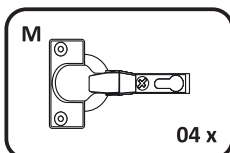
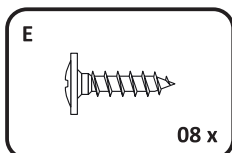
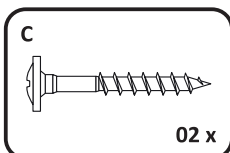
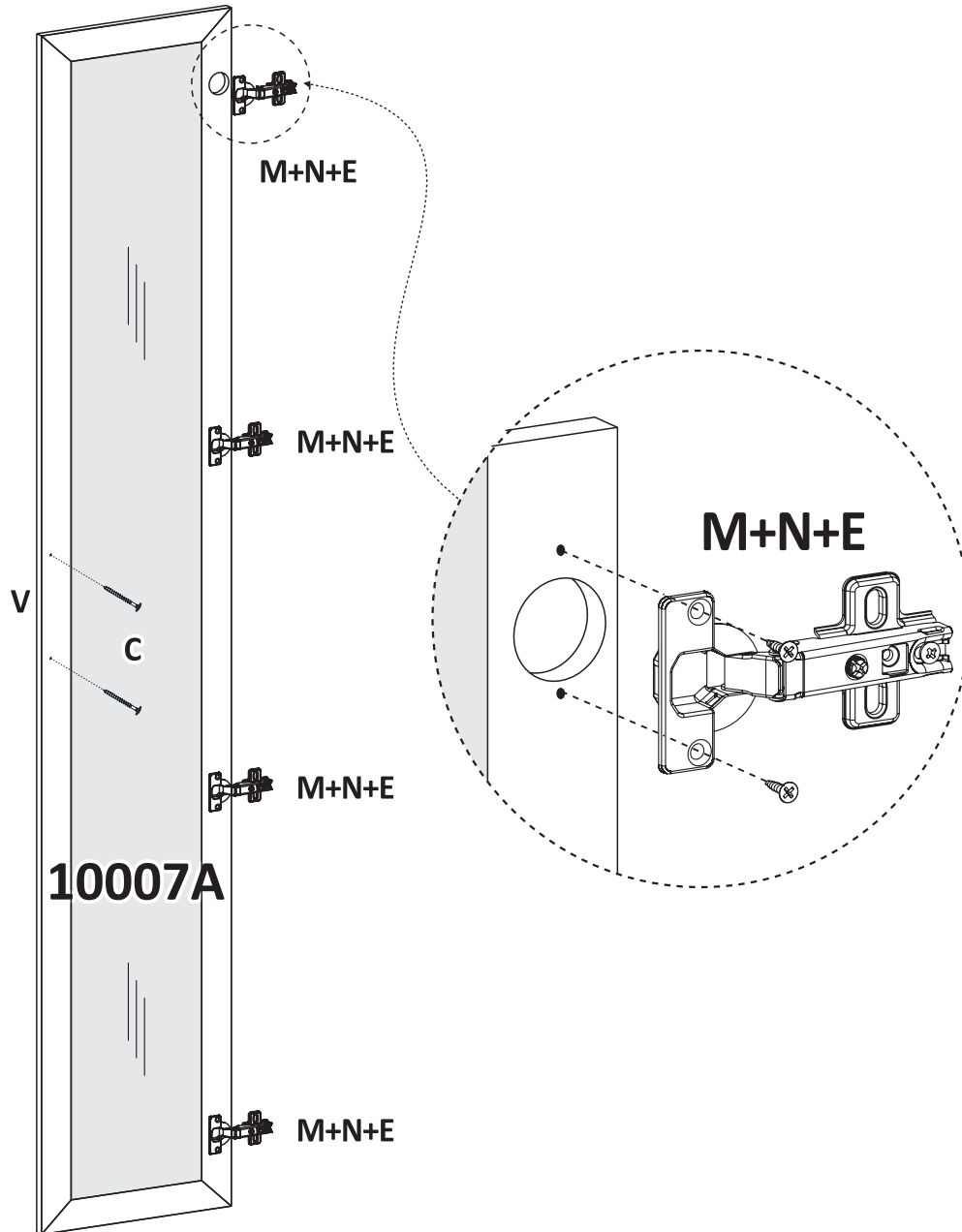

Montagem Porta Reflecta Direita.

Right Reflecta Door Assembly.

Montaje de la Puerta Reflecta Derecha.

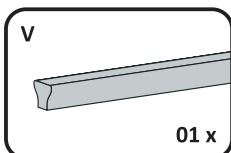
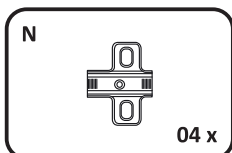
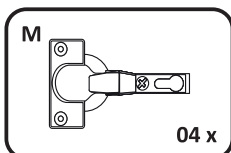
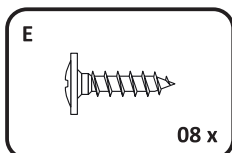
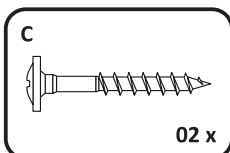
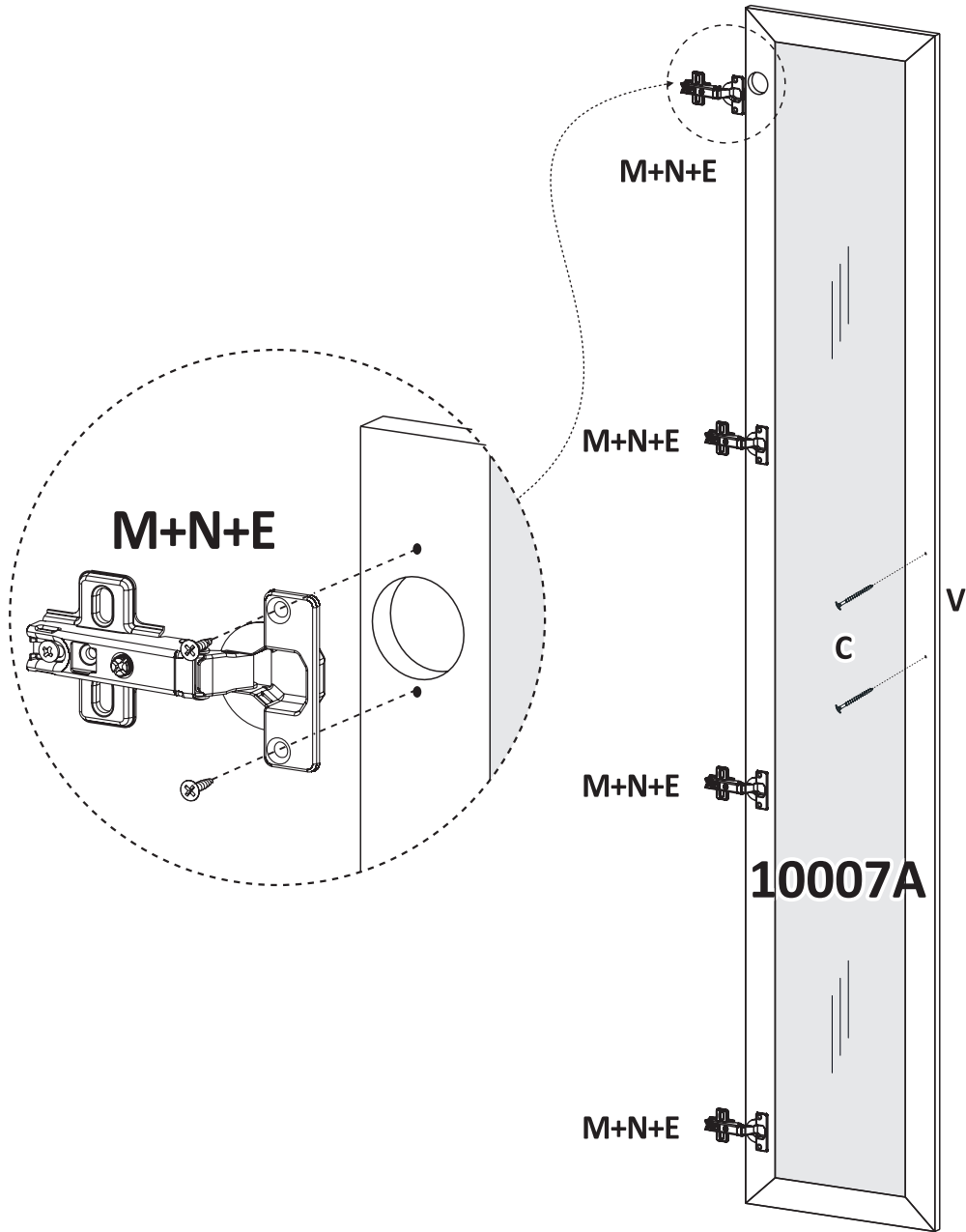

Montagem do Ripado.

Assembly Slatted.

Montaje de Ranurado.



**NÃO UTILIZAR
PARAFUSADEIRA**
DO NOT USE A SCREWDRIVER
No utilice un destornillador

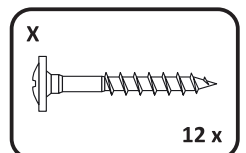
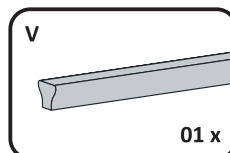
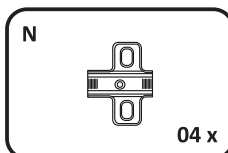
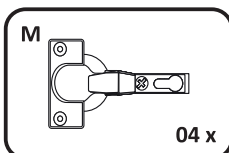
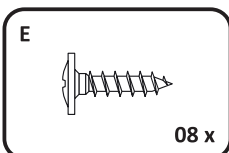
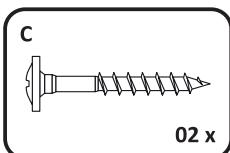
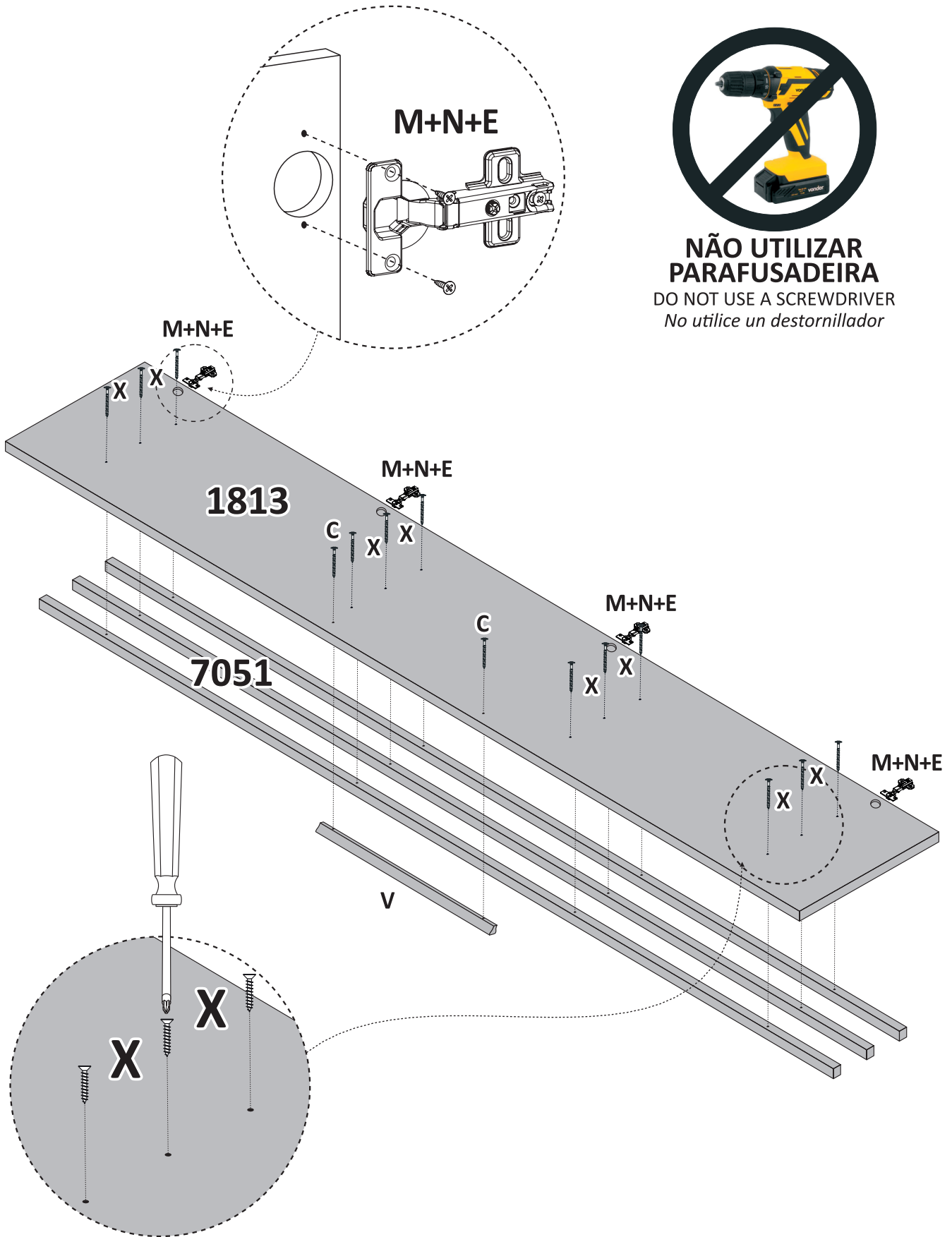

Coloção das Portas.

Door Placement.

Colocación de Puertas.

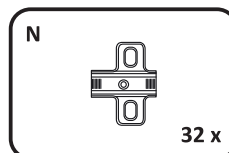
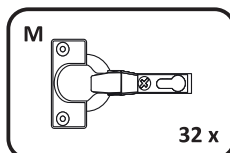
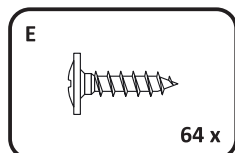
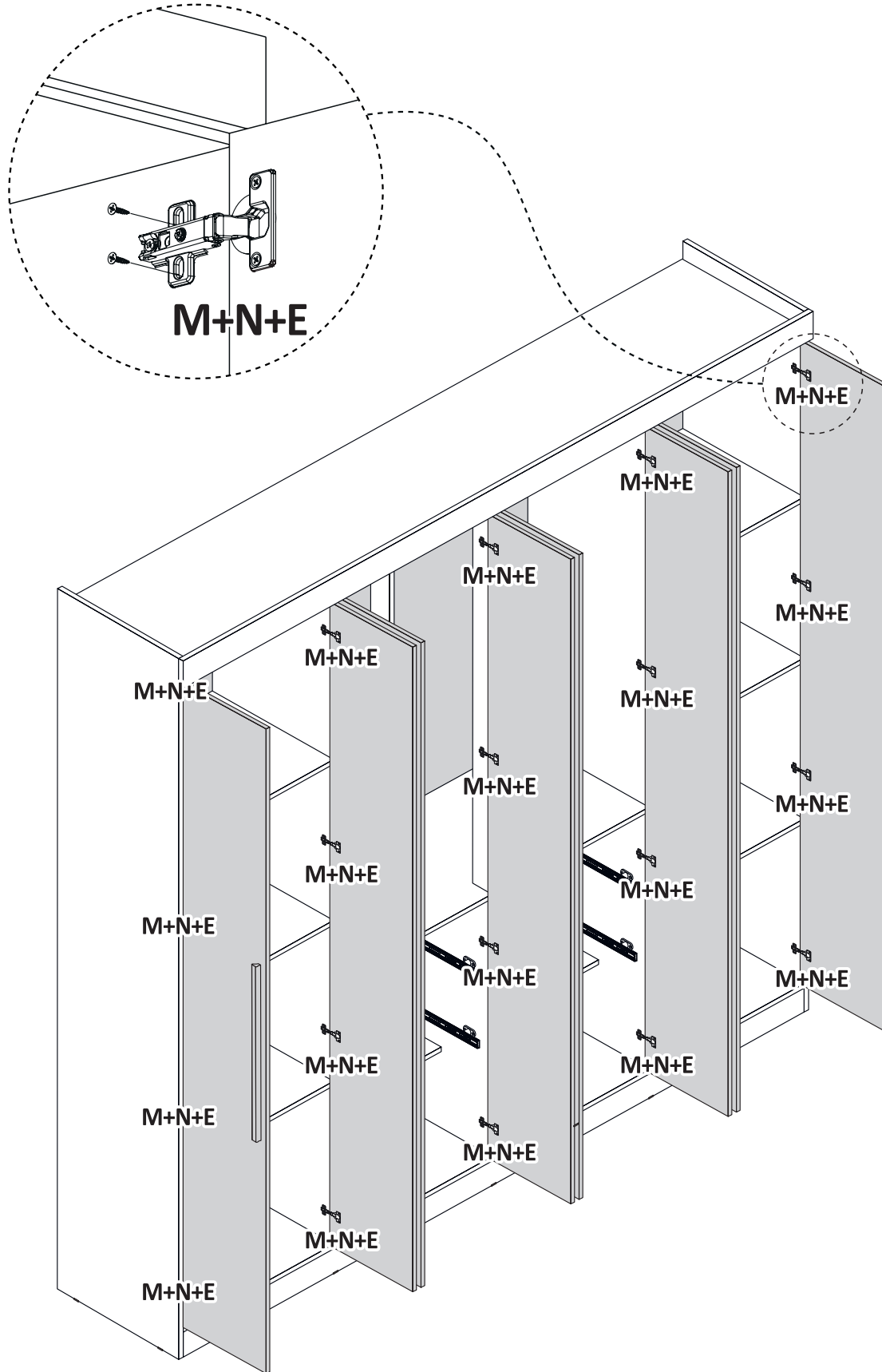

Montagem das Gavetas.

Assembling the Drawers.
Montaje de Cajones.

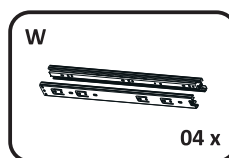
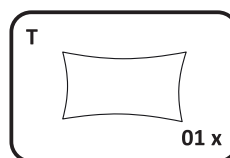
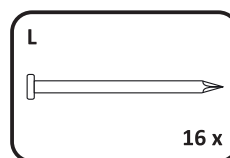
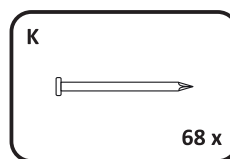
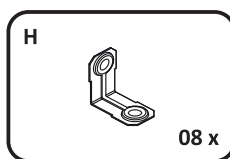
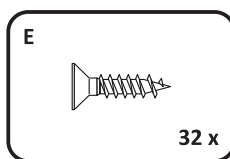
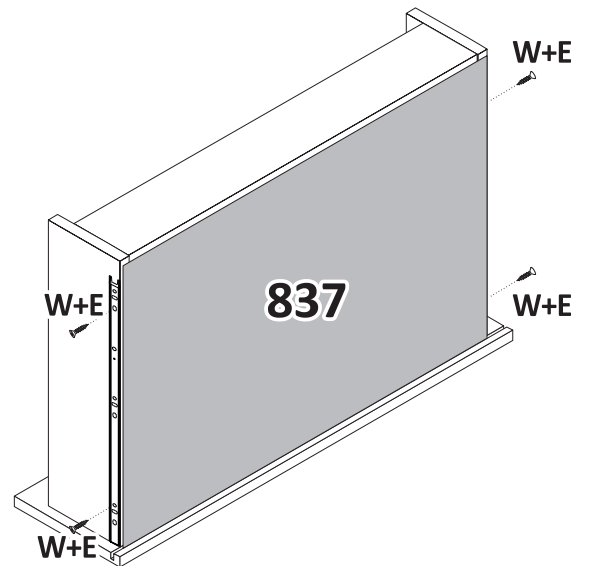
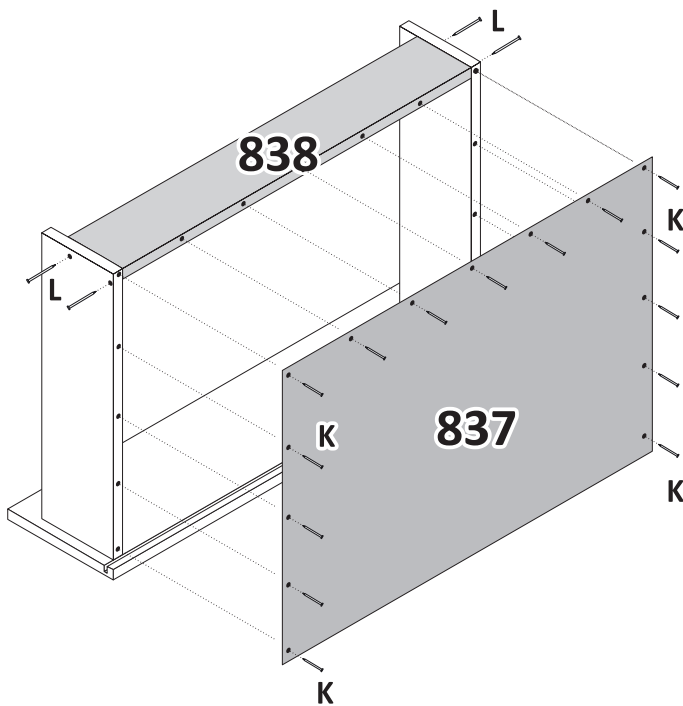
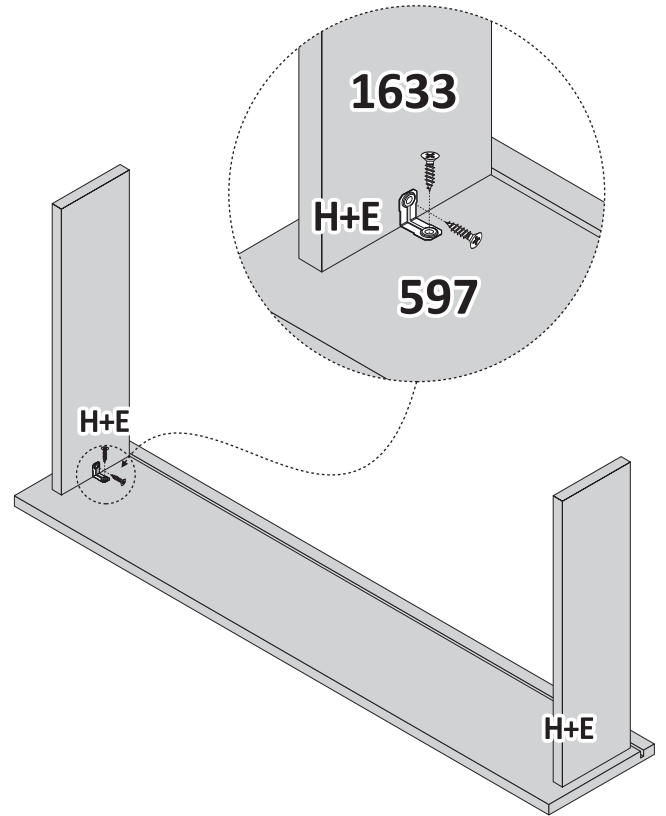
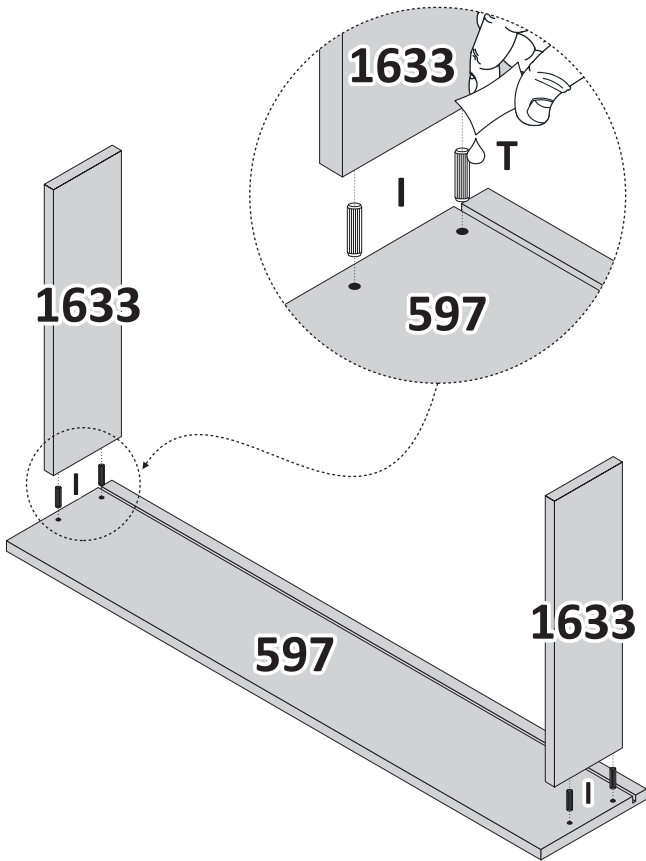

Produto montado.

Asembled product.
Producto ensamblado.

32 98887667
M

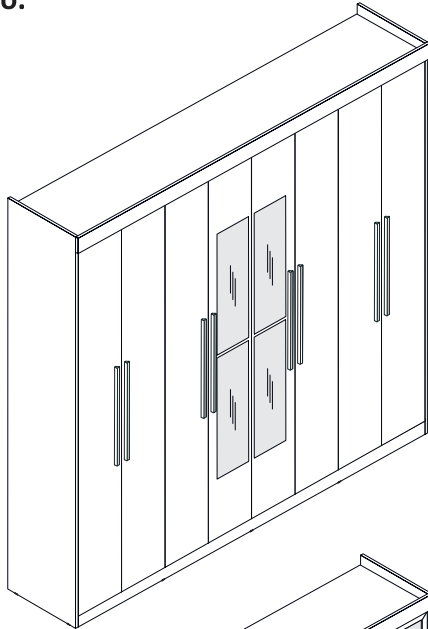

RP 60800

ESPELHO OPCIONAL
OPTIONAL MIRROR
ESPEJO OPCIONAL

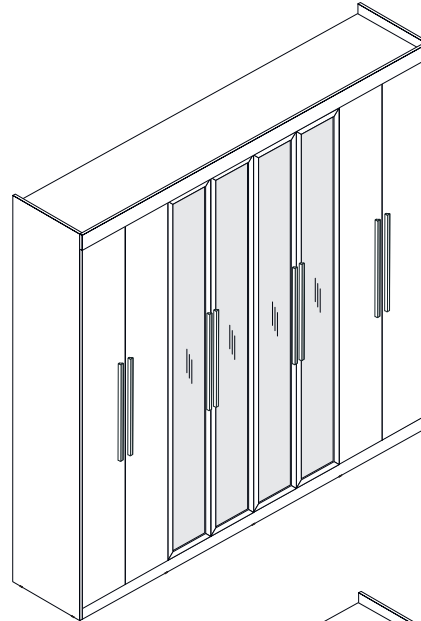

RP 68500

PORTA REFLECTA
REFLECTA DORR
PUERTA REFLECTA

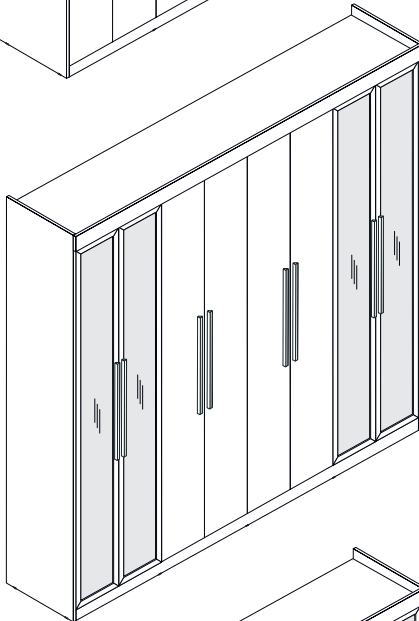

RP 68500

PORTA REFLECTA
REFLECTA DORR
PUERTA REFLECTA

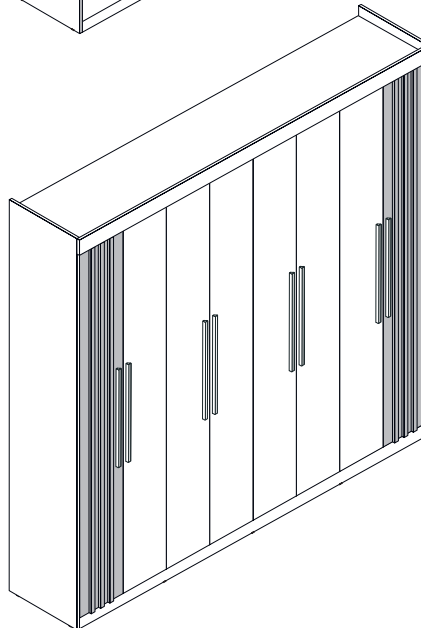

RP 45850

PORTA RIPADA
SLATTED DOOR
PUERTA RANURADA

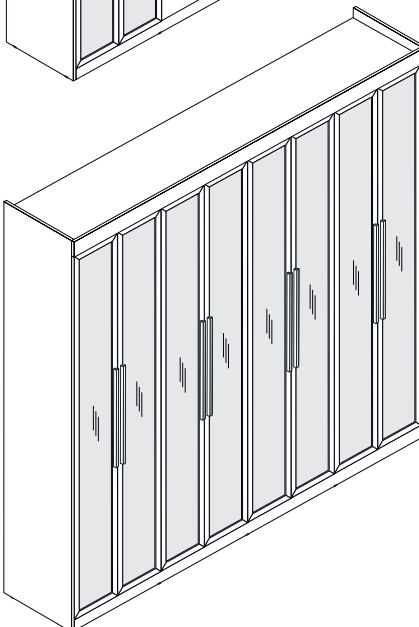

RP 70300

PORTA REFLECTA
REFLECTA DORR
PUERTA REFLECTA

Doripel
móveis

Moveis.Doripel 

DoripelMoveis 

54 3358.6500 

Av. Julio Vanzin, 1600 - Área Industrial Lagoa Vermelha - RS - Brasil 

comercial@doripel.com.br | assistencia@doripel.com.br 

doripel.com.br 