

RP3637 - ROUPEIRO

Manual de Montagem
 Assembly Instructions
 Instrucción de Montaje



6°

P38
02 UN

C2
01 UN

P7
10 UN

7°

P38
03 UN

C2
02 UN

P7
14 UN

8°

C2
08 UN

P7
04 UN

9°

P12
32 UN

P38
24 UN

Ct1
16 UN

10°

Ct1
07 UN

P12
14 UN

Ferramentas necessárias
 Necessary tools
 Herramientas necesarias

120min.

1 montador
 1 ajustador
 1 Fitter

www.decibal.com.br

RP3637 - ROUPEIRO

Manual de Montagem
 Assembly Instructions
 Instrucción de Montaje

decibal[®]
 móveis

11°

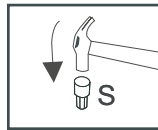
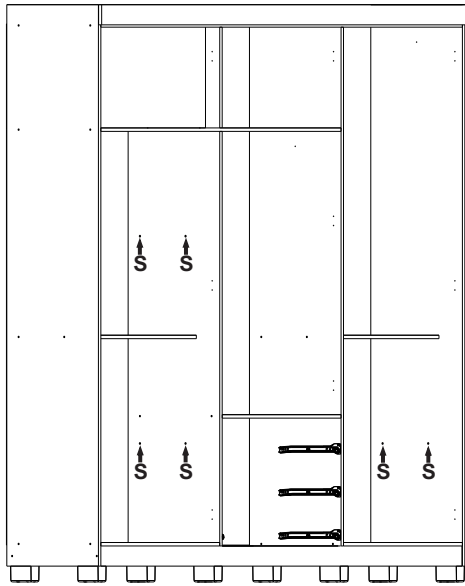

S
 12 UN

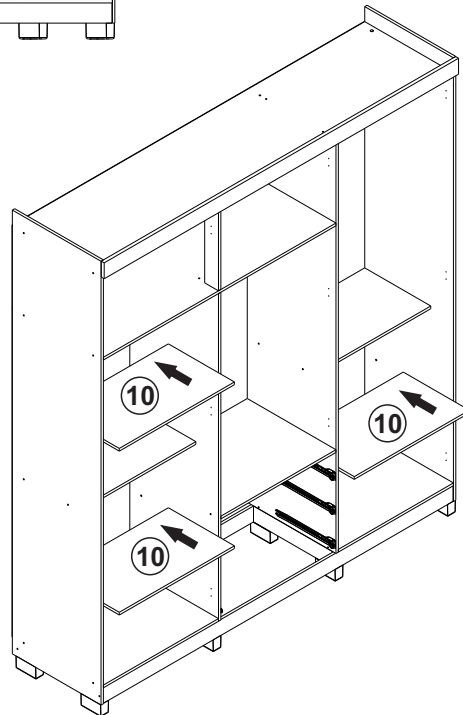

12°

x3

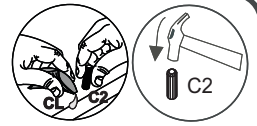
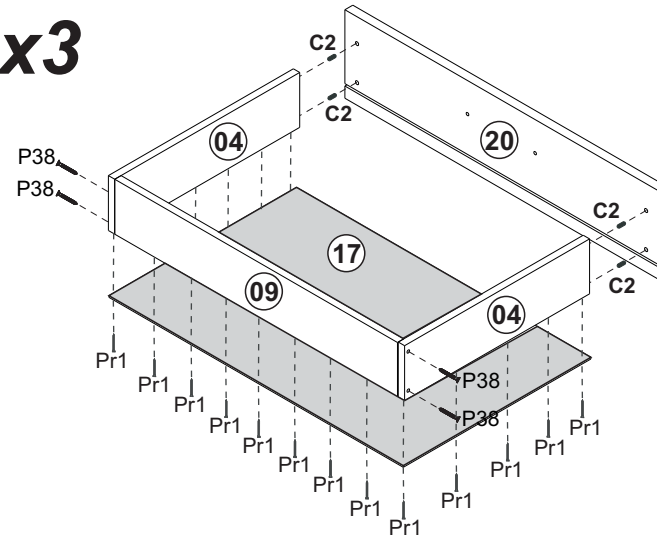

C2
 04 UN

P38
 04 UN

x3

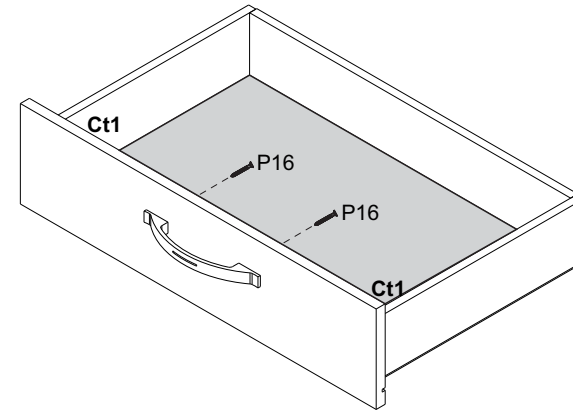

Ct1
 02 UN

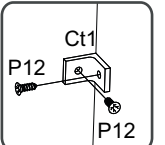

P16
 02 UN

x3

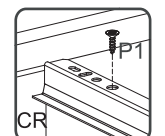
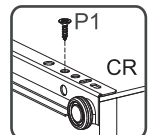
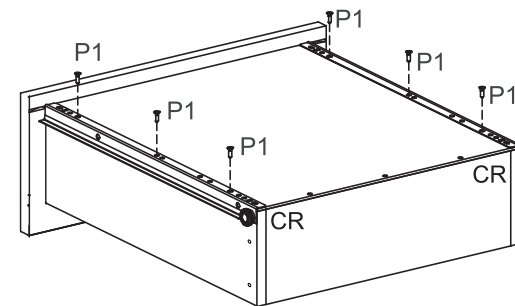

P12
 06 UN

RP3637 - ROUPEIRO

Manual de Montagem
 Assembly Instructions
 Instrucción de Montaje

decibal[®]
 móveis

13°

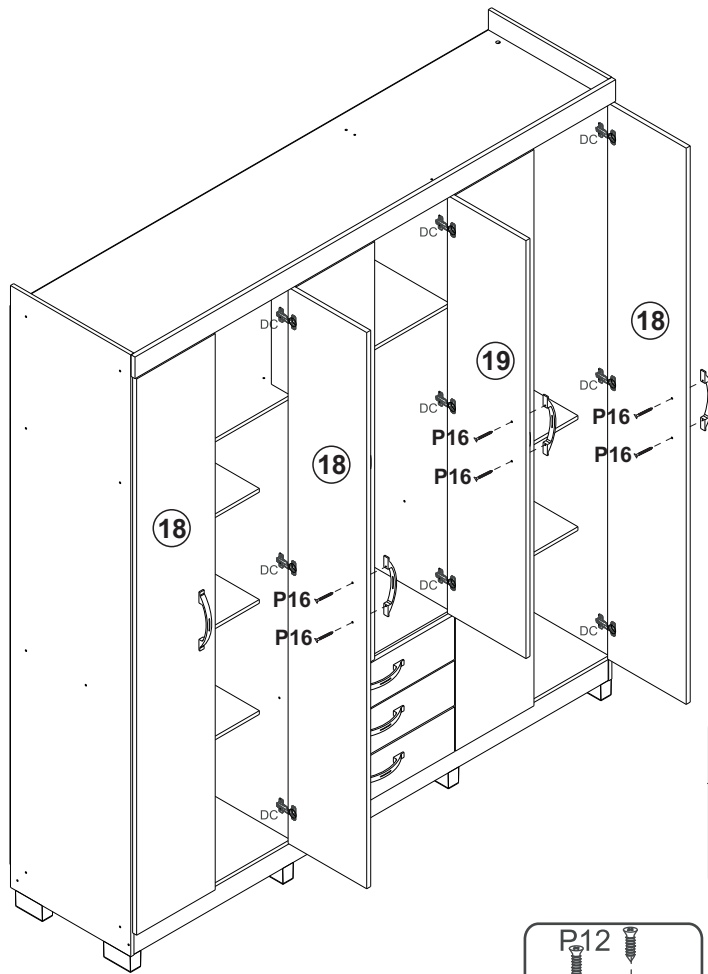

P16
 18 UN

P12
 72 UN

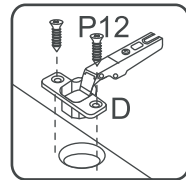
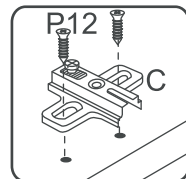
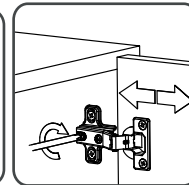
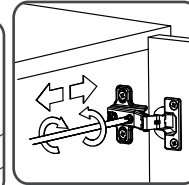
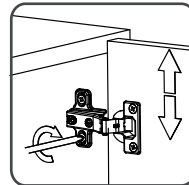

14°

PESO SUPORTADO/PESO SOPORTADO/ WEIGHT SUPPORTED

P1
 08 UN

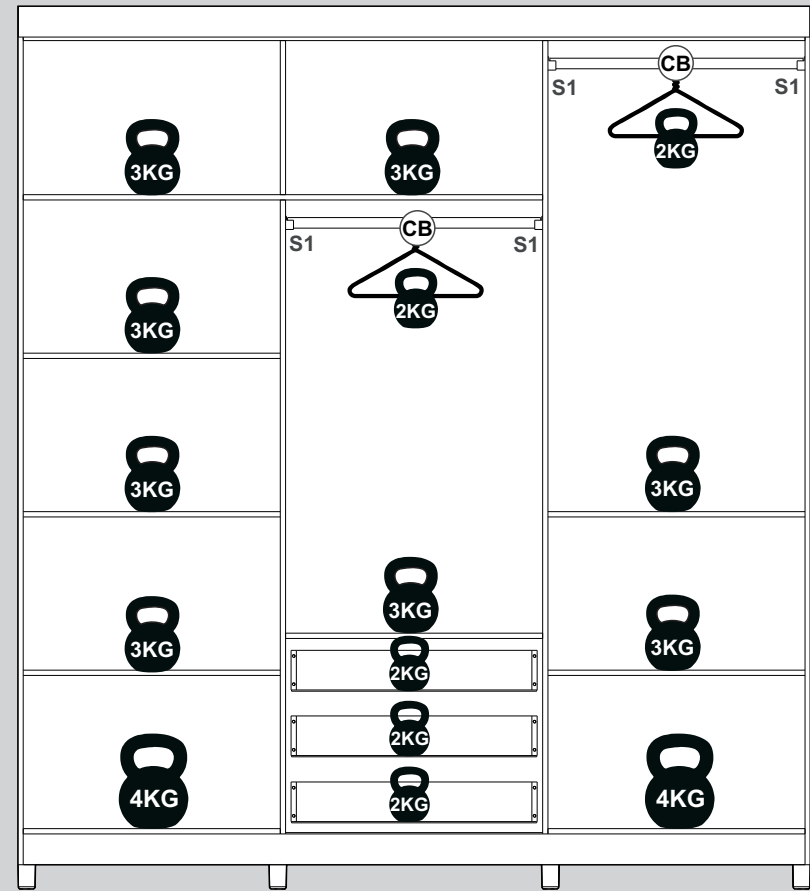
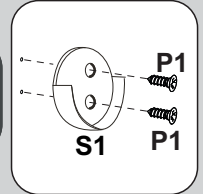

RP3637 - ROUPEIRO

Manual de Montagem
Assembly Instructions
Instrucción de Montaje









decibal[®]
móveis

Instrucción de Montaje

Relação de Peças/ Relación de Piezas/Parts List

Nº	CÓDIGO/CODE	DESCRIÇÃO/DESCRIPCIÓN/DESCRIPTION	QTD/CANT	VOL.	
1	0570158	LATERAL DIR/LATERAL/SIDE	1950X450X12MM	1	1
2	0570162	DIVISORIA/DIVIDER	1802X450X12MM	1	1
3	0570167	DIVISORIA ESQ/DIVIDER	1440X450X12MM	1	1
4	0570176	LAT GAV/LATERAL CAJÓN/DRAWER SIDE	350X90X12MM	6	1
5	0570159	RODAPE FRT/ZÓCALO/BASEBOARD	1776X70X12MM	1	1
6	0570160	RODAPE TRS/ZÓCALO/BASEBOARD	1776X70X12MM	1	1
7	0570152	RODAFORRO	1798X70X15MM	1	1
8	0570170	COSTA SUP	1196X366X2, 8MM	1	1
9	0570177	BATENTE/REVÉS CAJÓN/DRAWER BACK	535X90X12MM	3	1
10	0570163	PRATELEIRA MOVEL/ESTANTE/SHELF	584X335X12MM	3	1
11	0570156	PRATELEIRA FIXA/ESTANTE/SHELF	584X335X12MM	2	1
12	0570169	PILASTRA/PILASTER	350X70X12MM	1	1
13	0570161	RODAPE CENTRAL/ZÓCALO/BASEBOARD	404X70X12MM	2	1
14	0570168	BASE MALEIRO	1180X450X12MM	1	1
15	0570151	LATERAL ESQ/LATERAL/SIDE	1950X450X12MM	1	1
16	0570174	COSTA TRS GAV/REVÉS/BACK	448X596X2, 8MM	1	1
17	0570178	FUNDO GAV/FONDO CAJÓN/DRAWER BOTTOM	557X355X2, 8MM	3	1
18	0570164	PORTA/PUERTA/DOOR	1802X294X15MM	4	2
19	0570173	PORTA MENOR/PUERTA/DOOR	1354X294X15MM	2	2
20	0570175	FRENTE GAV/FRENTE CAJÓN/DRAWER FRONT	594X145X15MM	3	2
21	0570150	BASE SUP	1776X450X12MM	1	2
22	0570166	BASE	584X450X12MM	3	2
23	0570165	COSTA/REVÉS/BACK	1810X600X2, 8MM	1	2
24	0570172	COSTA INF/REVÉS/BACK	1444X600X2, 8MM	1	2
25	0570171	COSTA MEIO/REVÉS/BACK	996X596X2, 8MM	1	2

Escala (N/A)

LEGENDA	DESCRIÇÃO/DESCRIPCIÓN/DESCRIPTION	CÓDIGO	QUANT.
CL	 COLA/PEGAMENTO/GLUE	01213	01
ET	 ETIQUETA LOGO DECIBAL/LABEL DECIBAL	01312	01
Ct1	 CANTONEIRA/PIEZA L/SHEET	03077	31
DC	 DOBRADIÇA/BISAGRA/HINGE D=26mm C=5mm	12656	18
FX	 FIXADOR COSTA/FIJADOR FONDO/FIXER COAST	01331	46
S1	 SUPORTE CABIDEIRO/SOPORTE PERCHERO SUPPORT TO HANGER SUPPORT	02033	04
PE	 PE/PATA/FOOT 100X50X40MM	13084 CANELATO	08
CB	 CABIDEIRO/ROLIZO PERCHA/ROD FOR HANGERS 575 MM	03083	02

ATENÇÃO!!!! montadores e consumidores

* Para limpar o móveis utilize somente um pano úmido (umedecido em água pura ou água com sabão neutro). Depois, passe um pano seco. Evite a umidade excessiva.

* Evite usar álcool, água sanitária, detergente e outros produtos químicos, mesmo diluídos em água. Não utilize produtos abrasivos de nenhuma espécie

ATENCIÓN!!!! montadores e consumidores

* Para limpiar el mueble utilice solamente un paño húmedo (humedecido con agua limpia o con un jabón suave).

A continuación, utilice un paño seco. Evite el exceso de humedad.

* Evite uso de alcohol, hipoclorídico solución basada, detergente y otros productos químicos, mismo diluídos en agua.

ATTENTION!!!! assemblers and consumers

No utilize productos abrasivos de ningún tipo.

* To clean the furniture, use only a damp cloth (humidify it only in pure water or water and neutral soap). After, use a dry cloth. Avoid excessive humidity.

* Avoid using alcohol, bleach, detergent and other chemical products, even diluted in water. Do not use any kind of abrasive cleaning agents to clean the furniture.









The use of such products may jeopardize the final characteristics of the furniture.

RP3637 - ROUPEIRO





Manual de Montagem
Assembly Instructions
Instrucción de Montaje

decibal[®]
móveis

Escala (1:1)

LEGENDA	DESCRIÇÃO/DESCRIPCIÓN/DESCRIPTION	CÓDIGO	QUANT.
P7	 PARAFUSO/TORDILHO/SCREW 4X45	01318	32
P12	 PARAFUSO/TORNILLO/SCREW 3,5X13	09927	134
P1	 PARAFUSO/TORNILLO/SCREW 3X12	01328	44
P38	 PARAFUSO/TORNILLO/SCREW 3,5X40	12425	42
P16	 PARAFUSO/TORNILLO/SCREW 3,5X25	09955	18
Pr1	 PREGO/CLAVO/NAIL 10X10	01330	160
B	BUCJA/BUJE/BUCHING 	02734	32
C2	 CAVILHA/TARUGO/DOWEL 6X30 MM	01211	26
C3	 CAVILHA/TARUGO/DOWEL 6X50 MM	01212	01

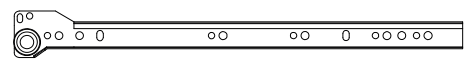
Escala (N/A)

LEGENDA	DESCRIÇÃO/DESCRIPCIÓN/DESCRIPTION	CÓDIGO	QUANT.
S	 SUPORTE /SOPORTE /SUPPORT	01368	12
PX	 PUXADOR/PEGADOR/HANDLE	12343	09
CR	 CORREDICA/CORREDERA/METALLIC SLIDE 350MM	01225	03
AD	 ADESIVO/ADHESIVO/ADHESIVE	15mm	18

