



















## FERRAGENS / herrajes / hardware

<b>A</b>	Parafuso 3,5 x 40 Tornillo 3,5 x 40 Screw 3,5 x 40		<b>34</b>
<b>B</b>	Puxador Tirador Handle		<b>2</b>
<b>C</b>	Roldanas		<b>6</b>
<b>D</b>	Parafuso 3,5 x 25 c/c Tornillo 3,5 x 25 Screw 3,5 x 25		<b>2</b>
<b>E</b>	Prego 10 x 10 c/c Clavo 10 x 10 Nail 10 x 10		<b>110</b>
<b>F</b>	Parafuso 3,5 x 12 c/c Tornillo 3,5 x 12 Screw 3,5 x 12		<b>80</b>
<b>G</b>	Prego 13 x 15 c/c Clavo 13 x 15 Nail 13 x 15		<b>8</b>
<b>H</b>	Fixador Fijador Fixer		<b>16</b>
<b>I</b>	Suporte Apoyo Support		<b>8</b>
<b>J</b>	Suporte Cabideiro Apoyo Percha Support Hanger		<b>4</b>
<b>K</b>	Cantoneira 22x22 Esquinera Corner		<b>10</b>
<b>L</b>	Sapata Zapata Shoe		<b>8</b>
<b>M</b>	Cavilha 6 x 30 Tacos Pegs		<b>10</b>
<b>N</b>	Corrediça Metálica 350mm Corrediza Slider		<b>2</b>
<b>O</b>	Distanciador p/ Corrediças Distanciador Distancer		<b>8</b>
<b>P</b>	Parafuso 3,5 x 16 c/c Tornillo 3,5 x 16 Screw 3,5 x 16		<b>24</b>
<b>Q</b>	Parafuso 3,5 x 14 c/c Tornillo 3,5 x 14 Screw 3,5 x 14		<b>2</b>
<b>R</b>	Cola Pegamento Glues		<b>1</b>
<b>U</b>	Cavilha 6 x 50 Tacos Pegs		<b>10</b>
<b>X</b>	Suporte Cabideiro Apoyo Percha		<b>1</b>
<b>T</b>	Trilho pvc (U) superior		<b>1</b>
<b>Z</b>	Trilho aluminio inferior		<b>1</b>

## MATERIAL PARA MONTAGEM Material Para Armado / Assembly Material

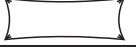
**MARTELO**  
Martillo  
Hammer

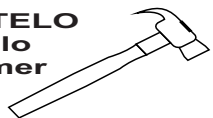

**CHAVE**  
Destornillador  
Screwdriver

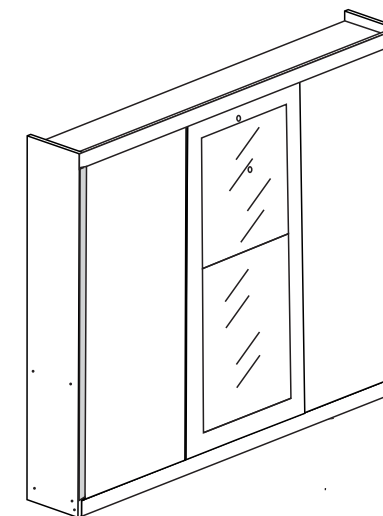
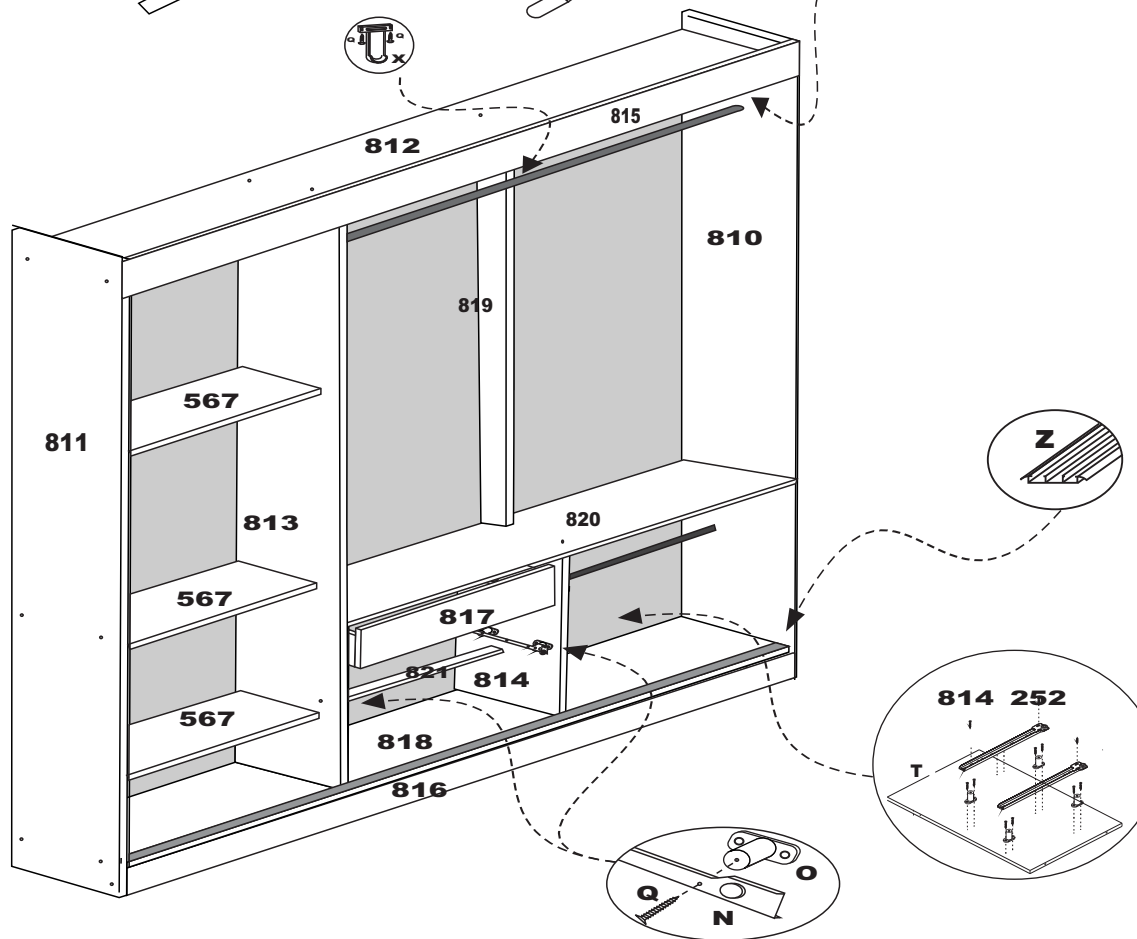

## NUMERAÇÃO DE PEÇAS

<b>821</b>	Reforço entre gavetas
<b>811</b>	Lateral Esquerda / Lateral izquierda/ left side
<b>810</b>	Lateral direita / Lateral derecha/ right side
<b>816</b>	Rodapé Frontal / Rodepié Frente/ front footer
<b>816</b>	Rodapé traseiro / Rodapié trazero/ back drawer
<b>815</b>	Roda-forro / Roda-forro/wheel - liner
<b>817</b>	Frente gaveta / Delantera cajón/ back drawer
<b>122</b>	Lateral gaveta / Lateral cajón/ side drawer
<b>838</b>	Trazeiro gaveta / Trazeiro cajón/ back side drawer
<b>822</b>	Fundo gaveta / Fondo cajón/ back drawer
<b>809</b>	Costas / Espalda/ back
<b>808</b>	Porta / Puerta/big door
<b>812</b>	Tampo superior / Tampo superior/ top higher
<b>818</b>	Tampo baixo / Tampo abajo/ top dawn
<b>813</b>	Divisão / División
<b>567</b>	Prateleira Móvel / Prateleira Mueble/mobile
<b>819</b>	Pilastras
<b>820</b>	Tampo Meio
<b>814</b>	Divisão / División

## ACESSÓRIOS

N°	DESCRIÇÃO
<b>00062</b>	Pau Cabide
<b>0177A</b>	Trilho Alumínio Inferior
<b>137-A</b>	Pau de Cabide
<b>2125</b>	Puxador
<b>4744</b>	Perfil E
<b>F 69000</b>	Kit Ferragem
<b>K 69000</b>	Kit Roldana
<b>2461</b>	Corrediça

**1º Passo / 1 Paso / 1 Step**

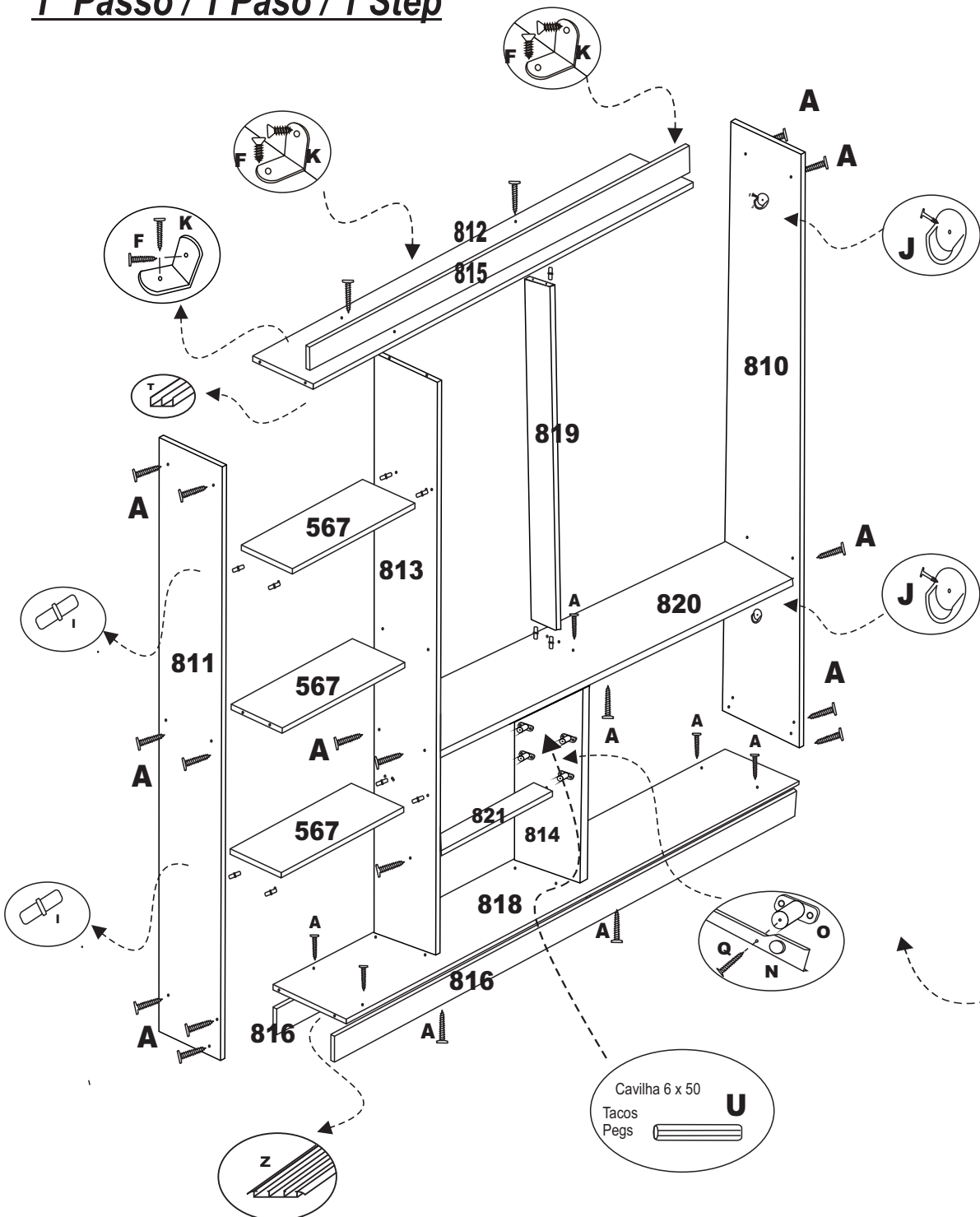

**2º Passo / 2 Paso / 2 Step**

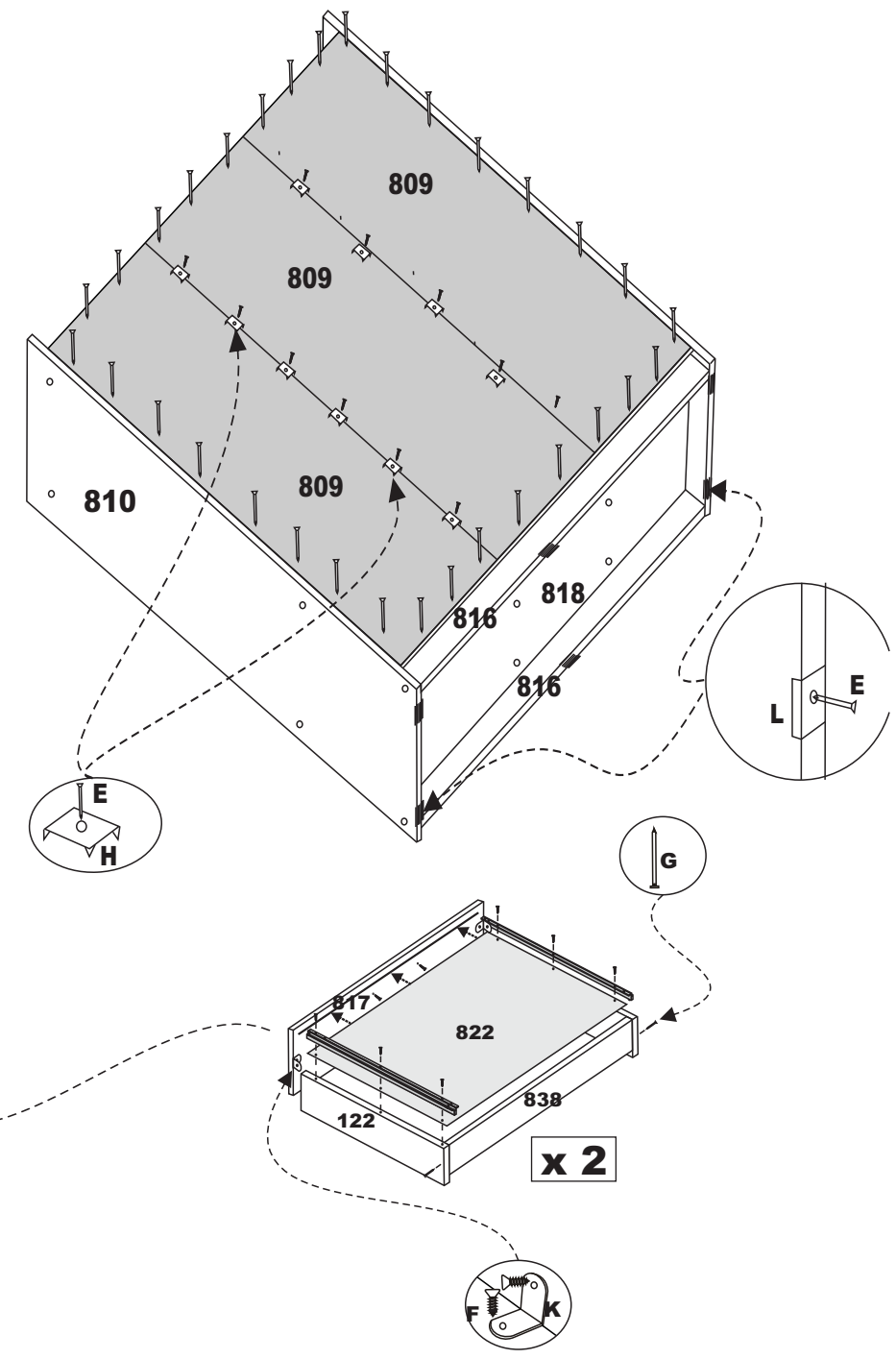

# ATENÇÃO MONTAGEM TRILHOS



x 3

**Obs:**  
Na parte de cima, encaixa a porta dentro do trilho 'U'.  
**Observación:**  
En la parte superior, se ajusta a la puerta en la barra 'U'.

**Obs:**  
Parte de Baixo da Porta  
**ROLDANA**  
**Observación:**  
Parte inferior de la puerta  
**POLEA**

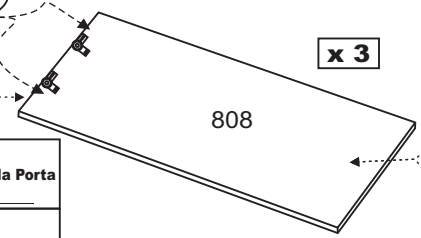

**Tampo Superior**  
**Cubierta Superior**

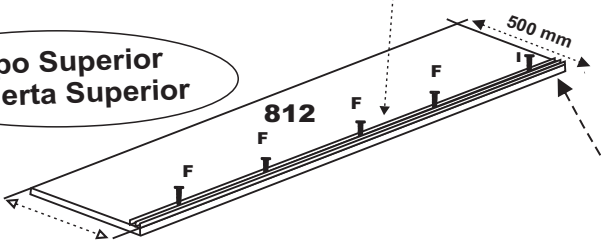

**Roda-forro / Roda-forro/wheel - liner**

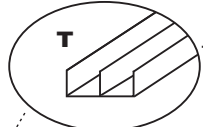

TRILHO SUPERIOR

**Tampo Inferior**  
**Cubierta Inferior**

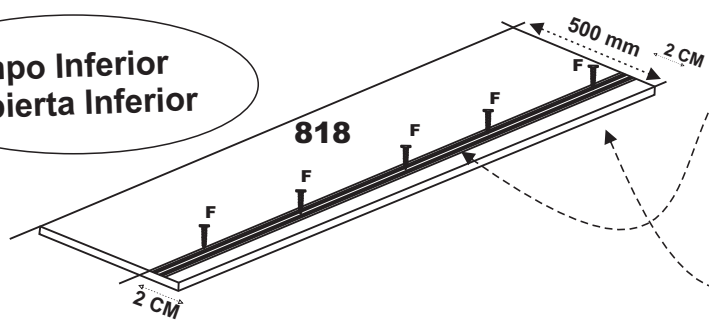

2 CM



TRILHO INFERIOR

**Obs:**  
Na parte de cima, encaixa a porta dentro do trilho 'U'.

**Observación:**  
En la parte superior, se ajusta a la puerta en la barra 'U'.

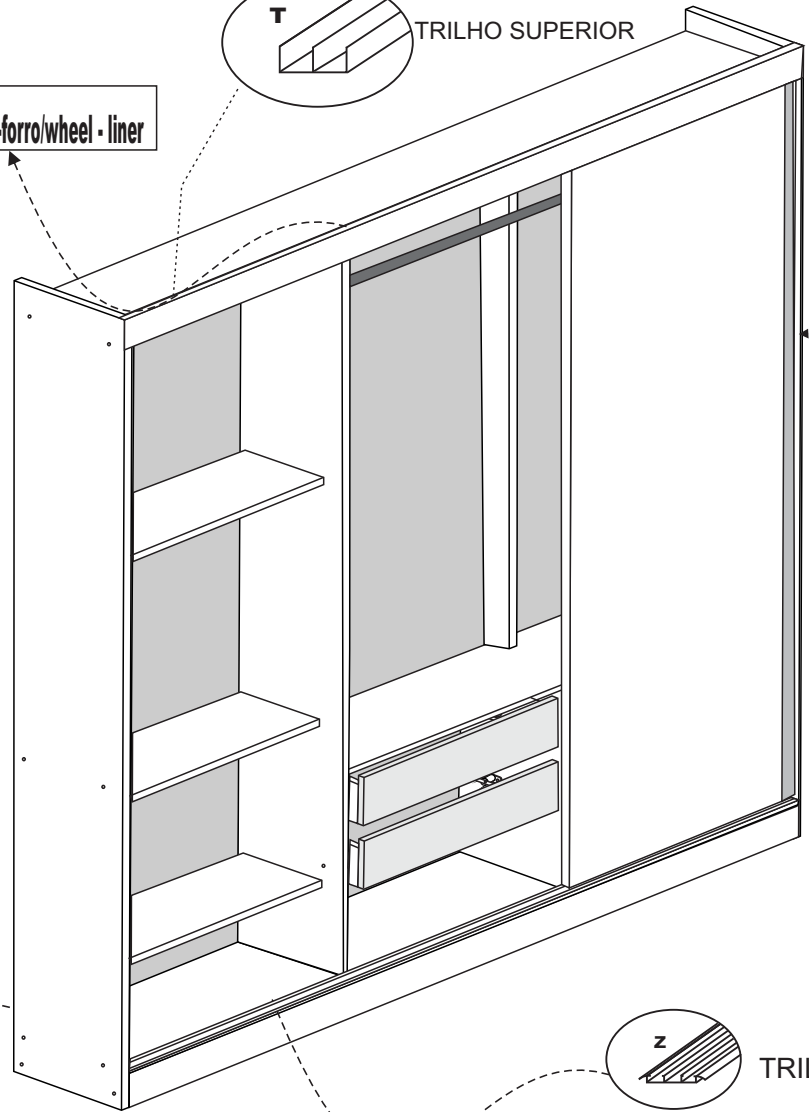

4º Passo / 4 Paso / 4 Step

**ATENÇÃO MONTAGEM PORTAS  
ESPELHOS.PUXADORES**

*Por puxadores, portas lateral  
do roupeiro.*

*Por espelho , porta  
central do roupeiro*

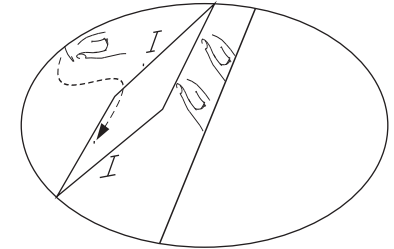
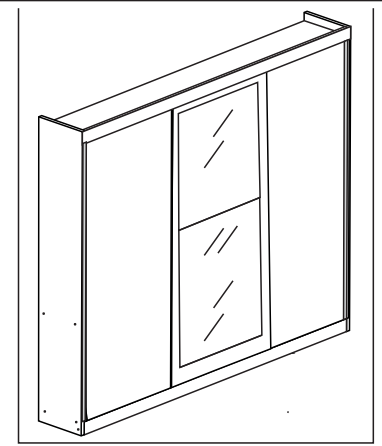

**OBS:**

USAR COMO MOLDE DE ALINHAMENTO PARA COLAGEM ESPELHOS, A PEÇA ( 77 ) RODAFORRO. PARA INICIAR A MONTAGEM ESPELHO DEIXANDO A MEDIDA LATERAL COM 0,75 MM CADA LADO DA PORTA. COMO MOSTRA DESENHO

