

## Montagem

# 6

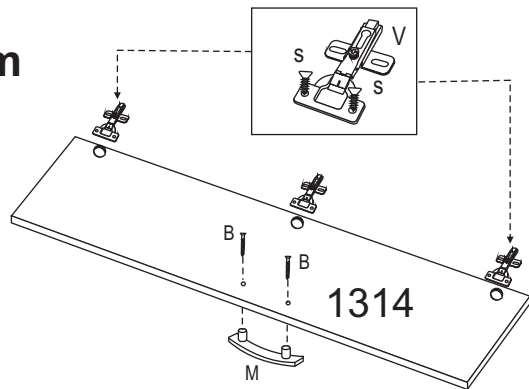

## Montagem

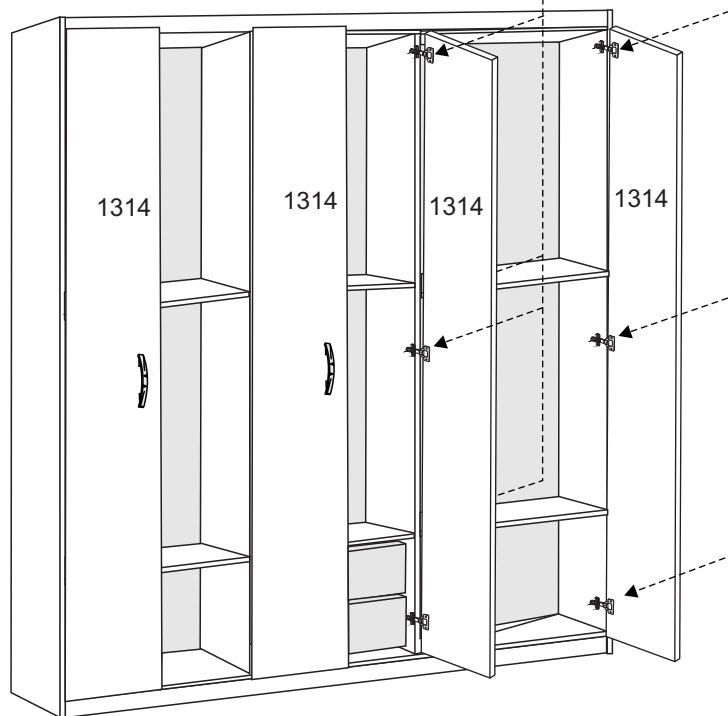
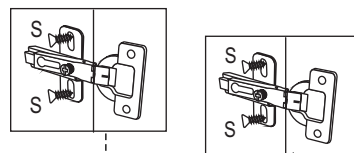

# 7















## Manual de Montagem











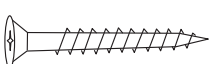

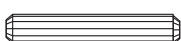

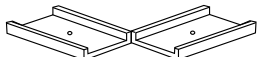
Por favor, antes de começar a montagem verifique se você recebeu todos os componentes e peças do produto. Caso contrário, entre em contato com a Casa do Cliente. Confira o telefone da sua região pelo site da Mobly ([www.mobly.com.br](http://www.mobly.com.br))

	
1 pessoa	2 pessoas

 Chave Phillips	 Chave Phillips Pequena	 Chave Fenda	 Chave Fenda Pequena	 Chave de Boca com XXmm	 Furadeira com Broca de XXmm
 Martelo Borracha	 Martelo	 Nível	 Trena	 Escada	 Esquadro

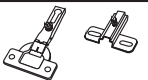
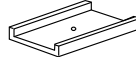
## Componentes das Ferragens:

A	Parafuso 3,5 x 40 c/chata		25
B	Parafuso 3,5 x 25 c/flangeada		12
C	Cantoneira 18x18		8
D	Cavilha 6 x 30		16
E	Prego 13 x 15		8
F	Prego 10 x 10		100
H	Sapata L 40 mm		4
J	Cola		1
L	Pino suporte Prateleira 8x5,5		20
M	Puxador 96 mm		6
P	Distanciador de Corrediça		8
S	Parafuso 3,5 x 12 c/Chata		120
U	Porca cilíndrica		12
V	Dobradiça 26 c/calço		18
X	Sapata U 15mm		2
Y	Fixador de costa		18

## Montagem



Cuidar para ficar no esquadro ao fixar os fundos para não ter problemas com as portas.

**5**

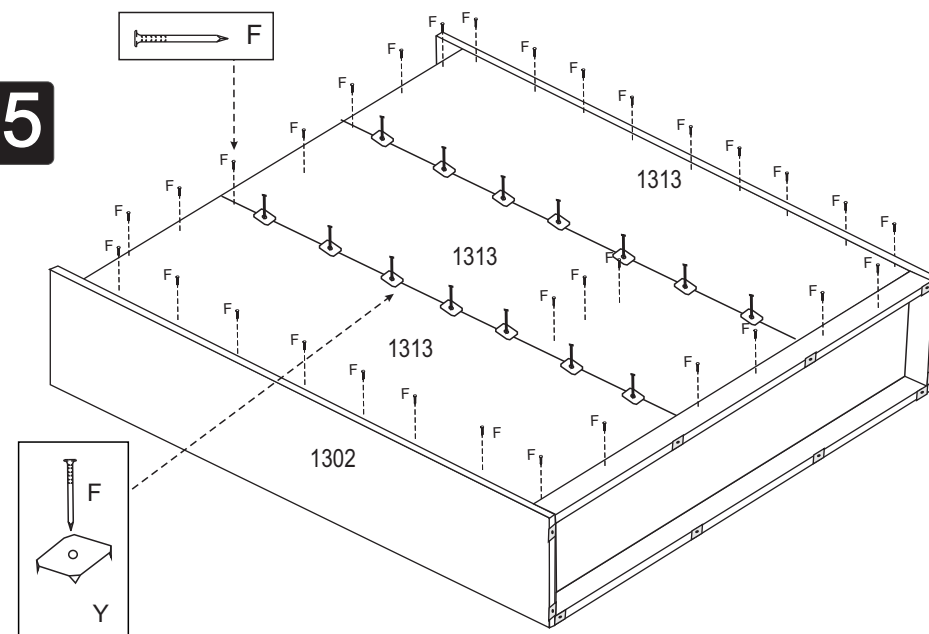

4

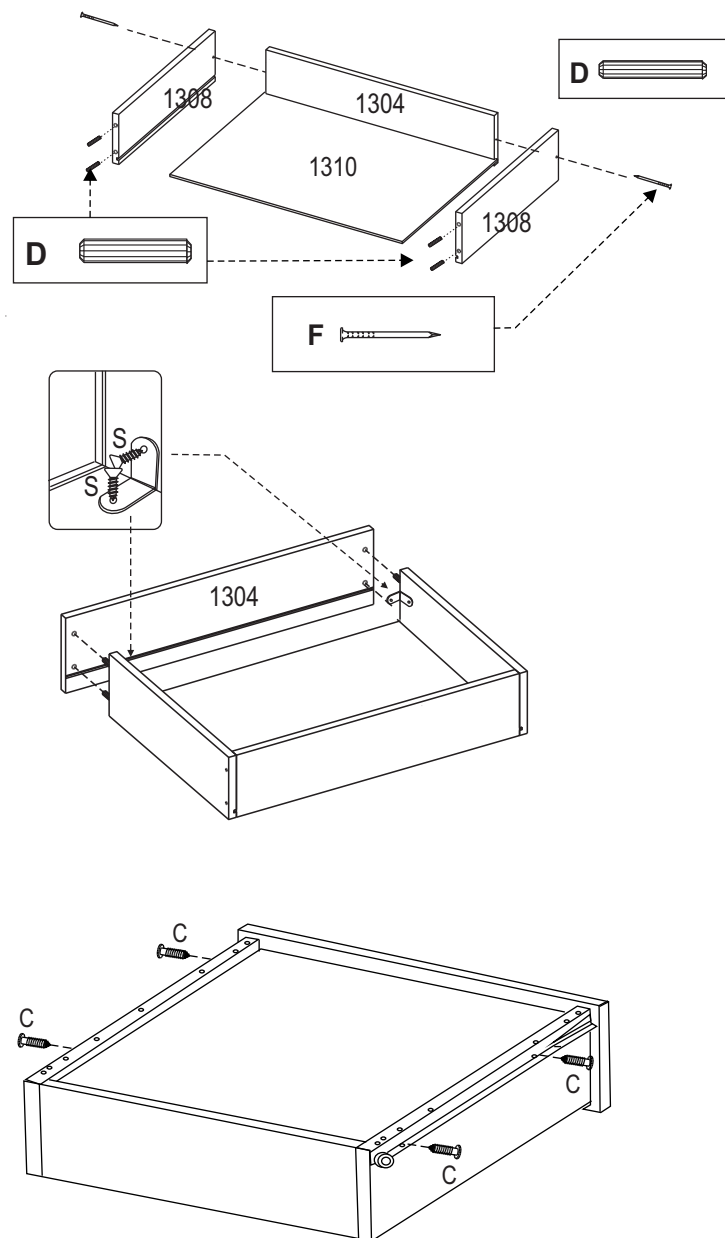

**Obs:** Para solicitar assistência técnica, utilize o código da ferragem ou peça indicada  
**Caixas A e B**

Cód.	Descrição da Peça	Unid.	Medida
1301	Lateral Esquerda	01	1830x385
1302	Lateral direita	01	1830x385
1305	Rodapé Frontal	01	1805x110
1306	Tampo superior	01	1805x385
1308	Lateral gaveta	04	350x100
1310	Fundo gaveta	02	350x485
1311	Encabeçamento	01	1805x60
1315	Divisória Direita	01	1633x385
1317	Tampo Inferior	01	1805x385
1318	Tampo central	01	592x385
1320	Rodapé Traseiro	01	1805x110
1321	Kit ferragem	01	
1322	Corrediça metálica	02	Pares
1304	Frente gaveta	02	540x140
1309	Traseiro gaveta	02	480x80
1313	Costa	03	1670x608
1314	Porta maior	06	1660x300
1316	Prateleira Móvel	05	592x385
1319	Divisória esquerda	01	1633x385

- Siga atentamente todas as instruções de montagem;
- Monte seu produto no local ou próximo de onde será colocado. Movimentações do produto já montado, podem avariá-lo;
- Faça a montagem em uma superfície limpa e plana. Aconselhamos usar a própria embalagem de papelão para forrar o chão;
- Verifique se as quantidades de peças e acessórios estão de acordo com o manual de montagem;
- Compare atentamente os furos de cada peça com a ilustração no manual;
- Utilize as ferramentas indicadas. Só utilize parafusadeira se tiver conhecimento e habilidade. O uso inadequado pode danificar peças e/ou acessórios;
- Se o produto solicitar fixação na parede, tenha o cuidado para não atingir fios e canos ao furar.

