

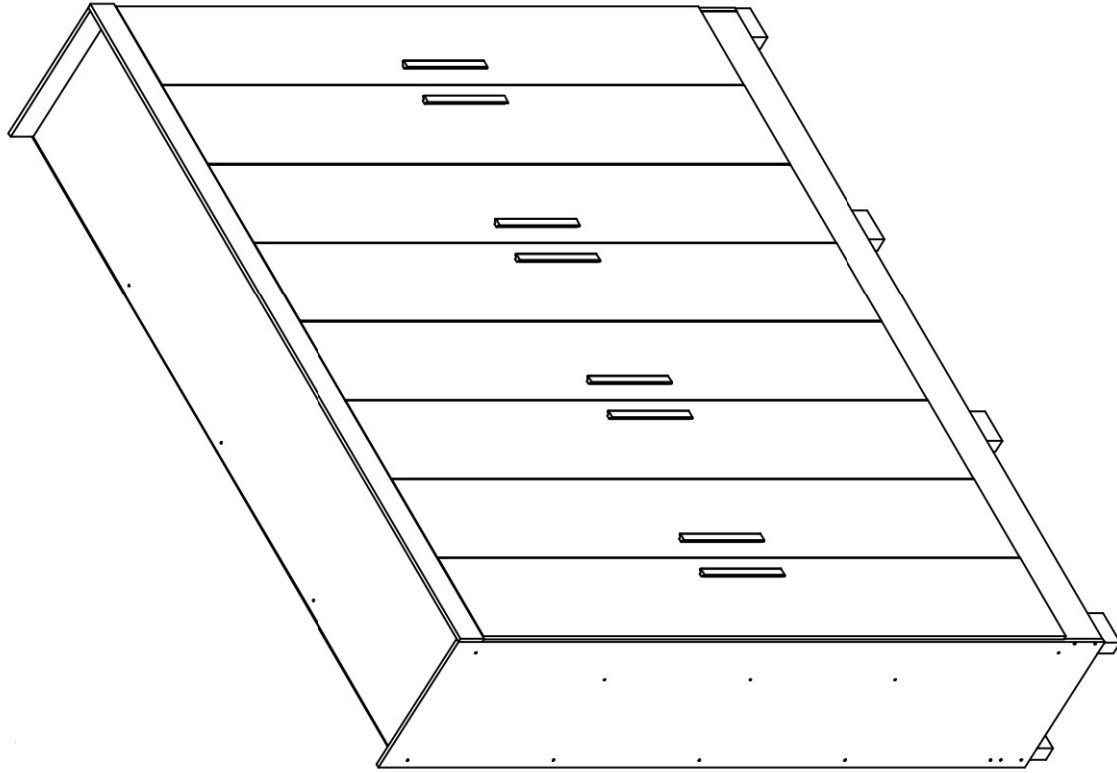



















MANUAL DE MONTAGEM
INSTRUCCIONES DE ARMADO
ASSEMBLY INSTRUCTIONS



Ferragens/Herrajes/Hardware

A		Cavilha Clevija Dowel 6x30	18
B		Tomillo de cabeça plana Flat head screw 3.5x40	58
C		Parafuso Flang. Flanged head screw 3.5x20	02
D		Contorneira de metal Metal angle bracket 22x22	17
E		Fixador de costas Fixer back	30
F		Prego Clavo Nail 10x10	100
G		Parafuso Flang. Flat head screw 3.5x12	198
H		Parafuso chato Flat head screw 3.5x25	16
I		Dobradilha com calço Bissagra com calço Hinge with shim	24
J		Puxador Tirador Handle 250mm	08
K		Cavilha Clevija Dowel 6x50	04
L		Prego Clavo Nail 13x15	08
M		Corredilha 350mm Corredera 350mm Sliding spacer	02
N		Afastador correção Distanciador corredera Sliding spacer	08
O		Cabideiro Perchero Hatstand support 524mm	02
P		Cabideiro Perchero Hatstand support 1066mm	01
Q		Suporte cabideiro Supporte perchero Hatstand support	01
R		Pé Pata Foot	08
S		Suporte cabideiro Supporte perchero Hatstand support	06
T		Bsnaga de cola Pegamento Glue	01

MANUAL DE MONTAGEM
INSTRUCCIONES DE ARMADO
ASSEMBLY INSTRUCTIONS

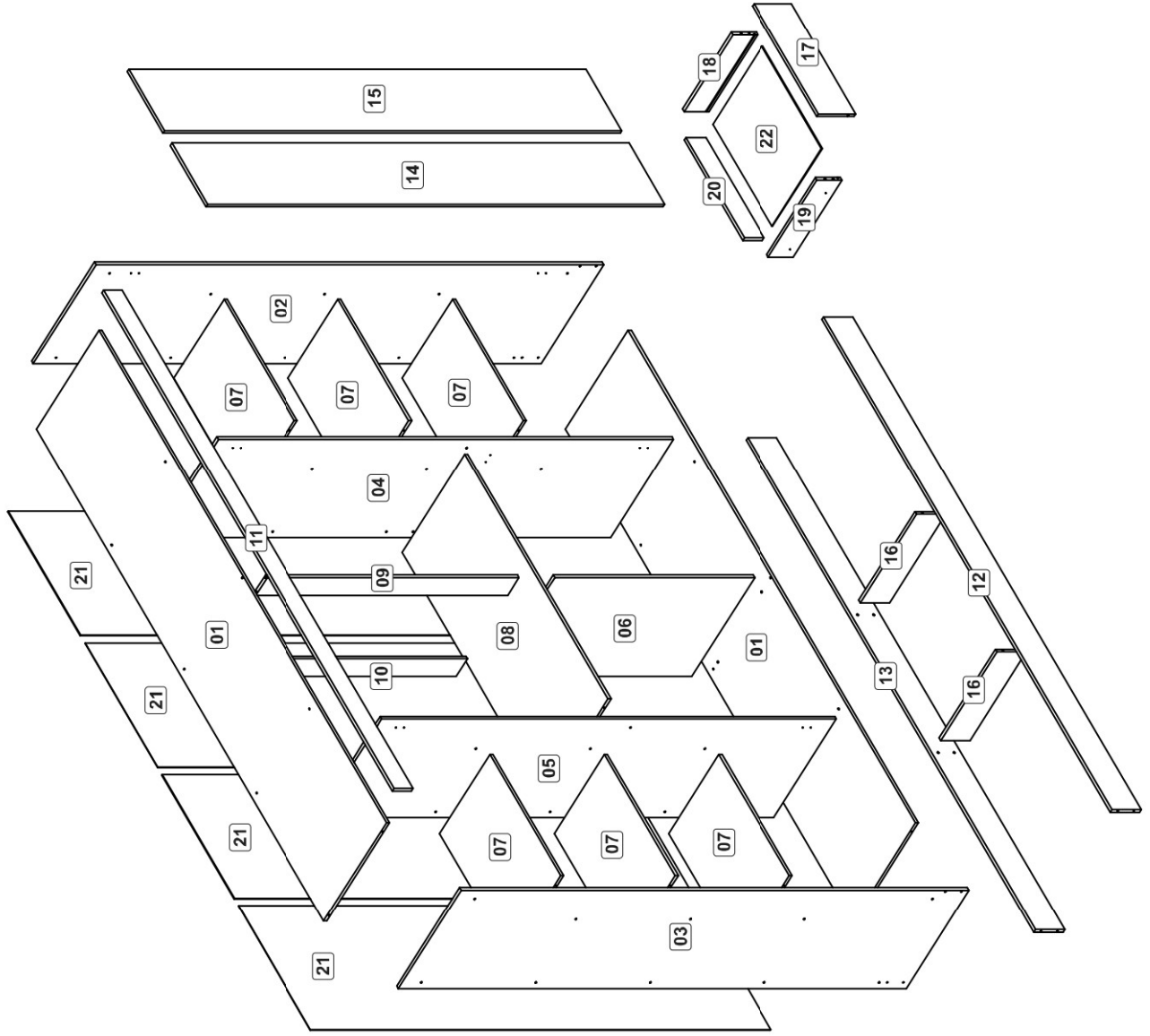

Relação de peças/ Relación de las piezas/Parts list

01	100.0001	Tampo-base/Tapa-base/Top and base	02	2156x450x12
02	102.0001	Lateral direita/Lateral derecha/Right side	01	2020x450x12
03	102.0002	Lateral esquerda/Lateral izquierda/Left side	01	2020x450x12
04	103.0001	Divisão dir/Divisoria derecha/Right division	01	1810x450x12
05	103.0002	Divisão esq/Divisoria izquierda/Left division	01	1810x450x12
06	103.0003	Divisão central/Divisoria central/Center division	01	794x450x12
07	104.0001	Prateleira fixa/Repisa fija/Fixed shelf	06	530x360x12
08	104.0002	Prateleira central/Repisa central/Center shelf	01	1072x450x12
09	105.0001	Pilastro dianteira/Travessão delantero/ Front crossbar	01	1004x80x12
10	105.0002	Pilastro traseira/Travessão traseiro/ Back crossbar	01	1004x80x12
11	107.0001	Rodaforro/Detaille superior/Upper detail	01	2180x74x12
12	108.0001	Rodapé frontal/Zócalo dianteiro Front baseboard	01	2156x116x12
13	108.0002	Rodapé traseiro/Zócalo de atrás Back baseboard	01	2156x116x12
14	109.0001	Porta/Puerta/Door	04	1820x268x12
15	109.0001	Porta/Puerta/Door	04	1820x268x12
16	106.0001	Reforço base/Reinuerzo base/Base reinforcement	02	404x116x12
17	200.0001	Fronte de gaveta/Frente cajón/Drawer front	02	484x150x12
18	201.0001	Lateral gav direita/Lateral cajón derecha Right drawer side	02	350x100x12
19	201.0002	Lateral gav esquerda/Lateral cajón izquierda Left drawer side	02	350x100x12
20	202.0001	Costa gaveta/Revés cajón/Drawer back	02	436x70x12
21	500.0001	Costa/Revés/Back	04	1832x542x3
22	500.0002	Fundo gaveta/Fondo cajón/Drawer bottom	02	446x355x3

VOCÊ VAI PRECISAR DE / USTED NECESITARÁ / YOU WILL NEED
Ferramentas não fornecidas / Herramientas no incluidas / Tools not supplied



Chave Phillips
Dois tipos
Screwdriver Phillips

Fita de medição
Measuring tape

Martelo
Hammer

Furadeira
Tubo
Drill machine

Montagem Gaveta (2x)
Montaje Cajone (2x)
Assembly Drawer (2x)

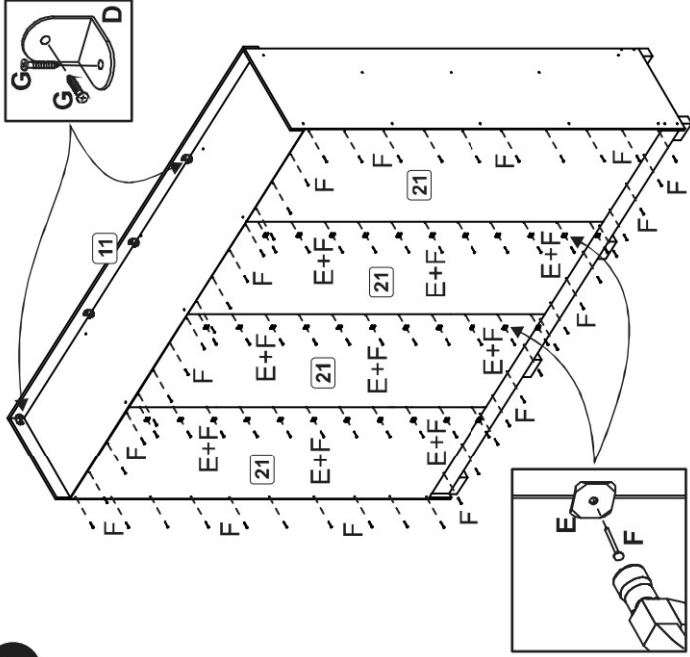
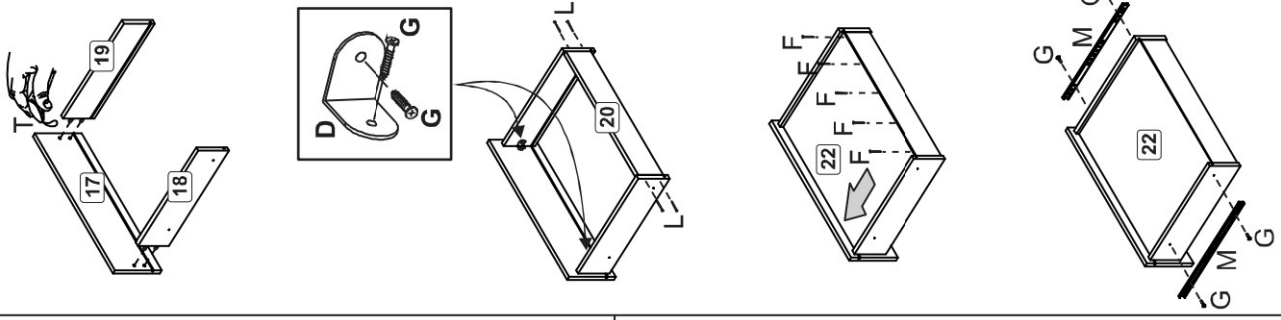

7

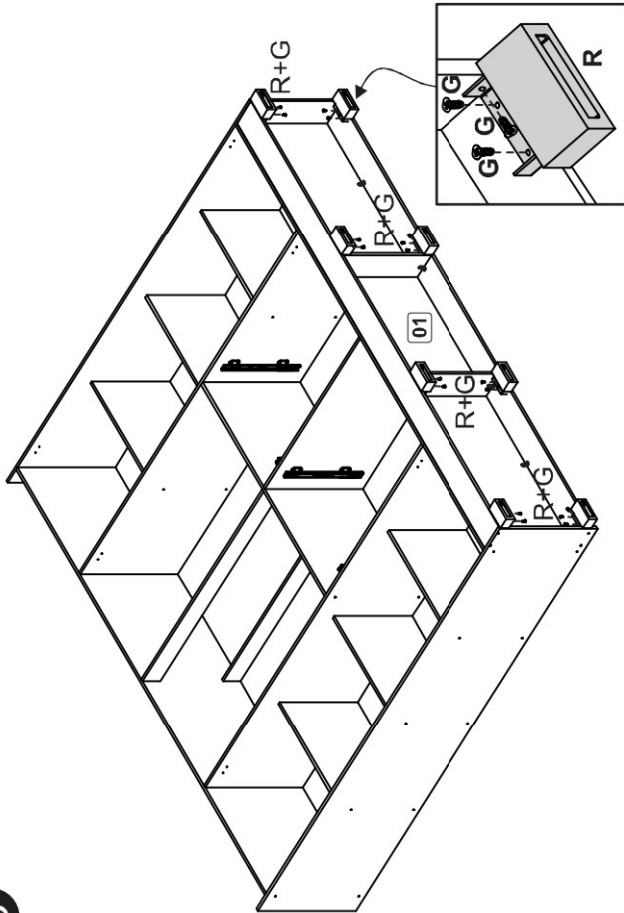

6

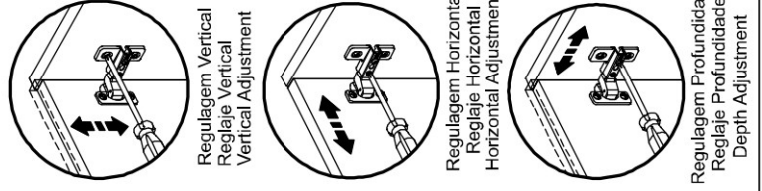

Regulagem Vertical
 Regleaje Vertical
 Vertical Adjustment

Regulagem Horizontal
 Regleaje Horizontal
 Horizontal Adjustment

Regulagem Profundidade
 Regleaje Profundidade
 Depth Adjustment

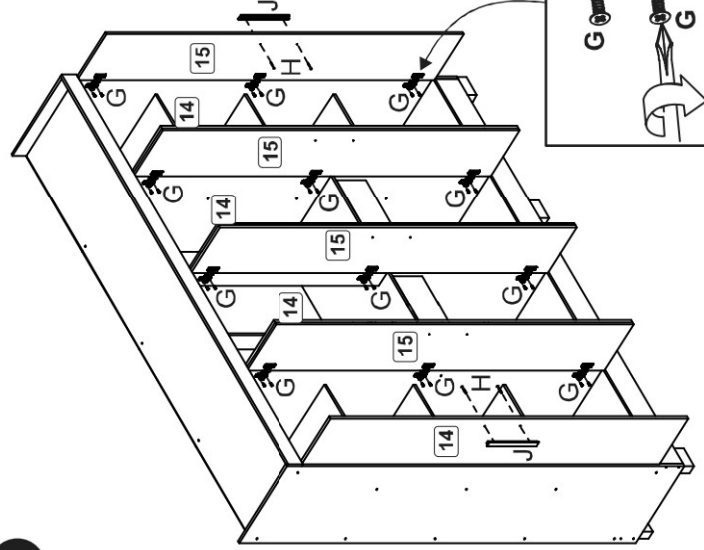

9

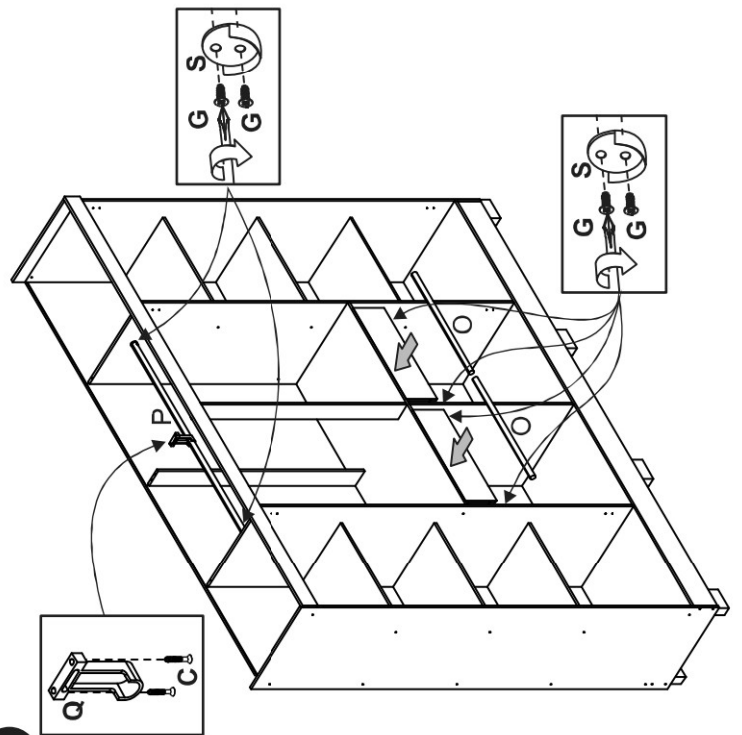

8