

RP1803 - ROUPEIRO

Manual de Montagem
 Assembly Instructions
 Instrucción de Montaje

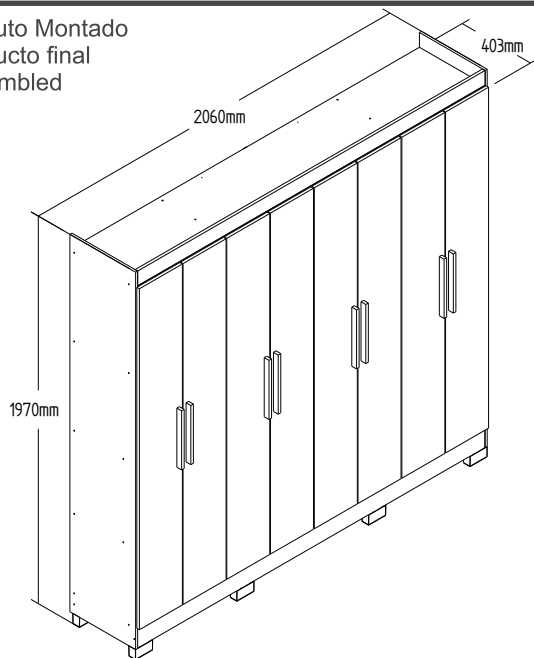

Produto Montado
 Producto final
 Assembled



01°

Ct1
 04 UNI

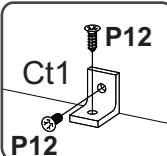

C2
 08 UNI

B
 04 UNI

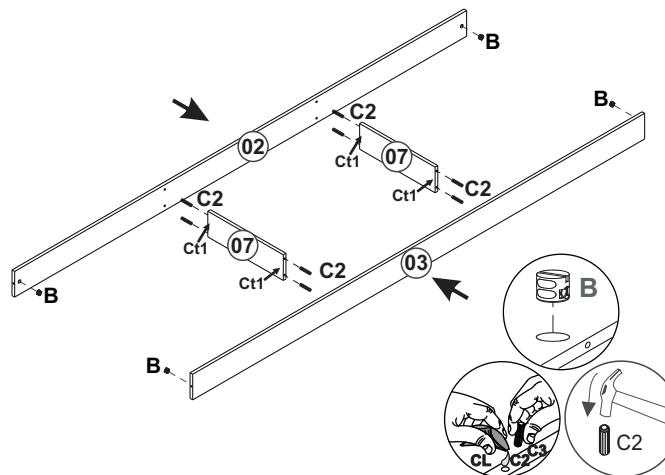

02°

C2
 06 UNI

P38
 8 UNI

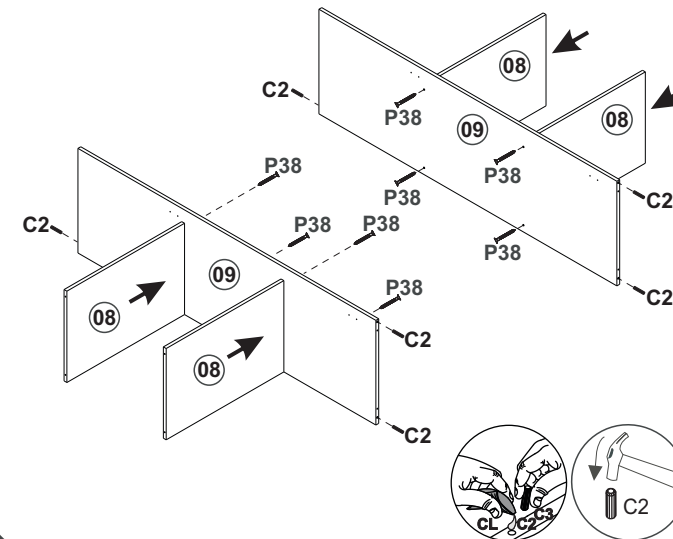

03°

C3
 6 UNI

P38
 7 UNI

C2
 1 UNI

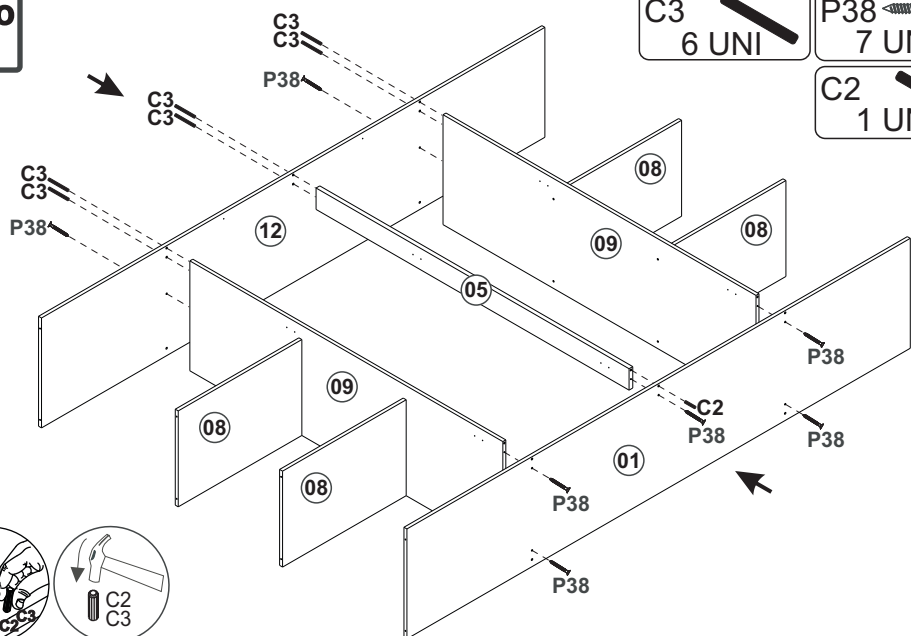

04°

P38
 16 UNI

C2
 03 UNI

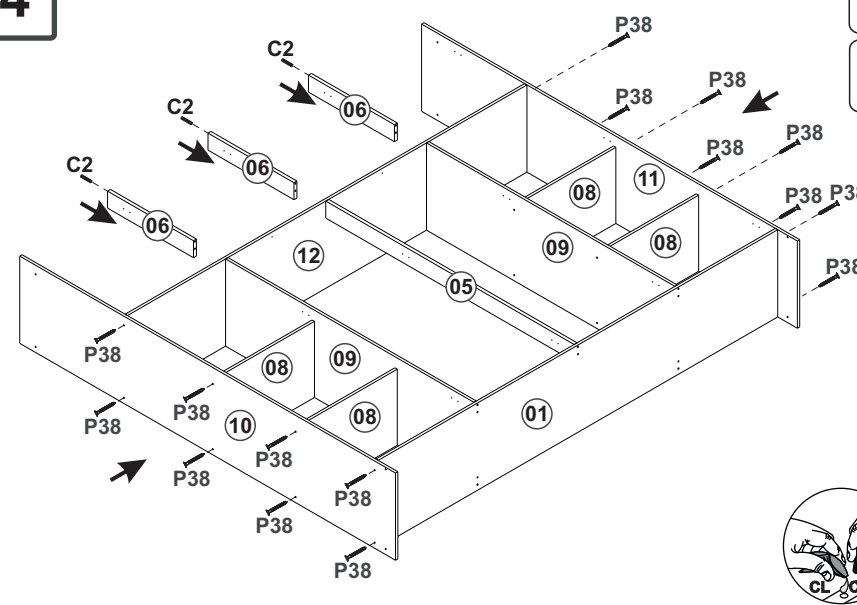

RP1803 - ROUPEIRO

Manual de Montagem
 Assembly Instructions
 Instrucción de Montaje



05°

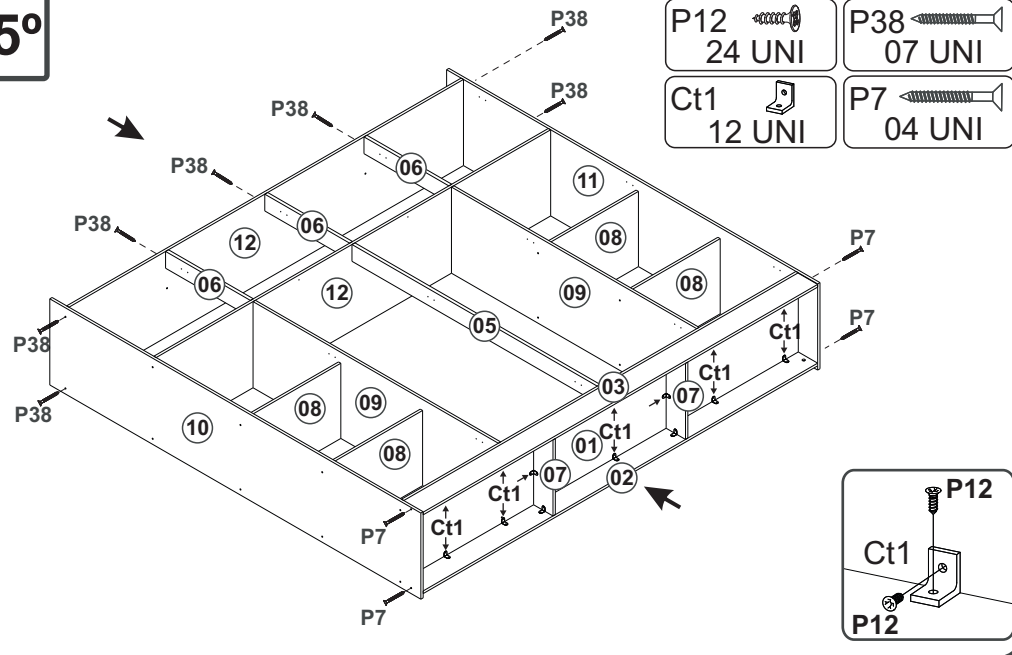

07°

COSTA/REVÉS/BACK

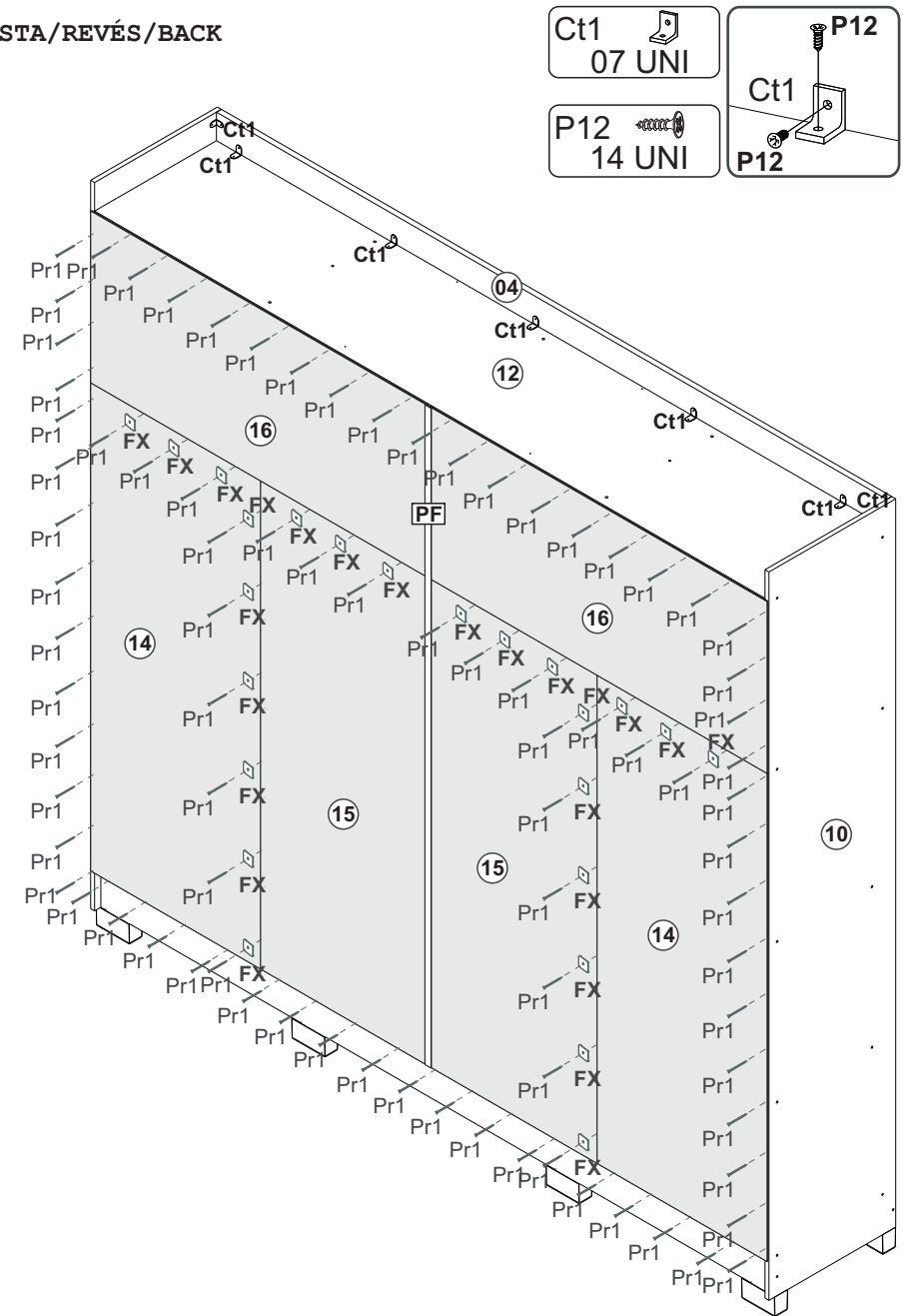
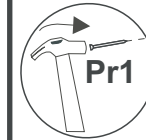

06°

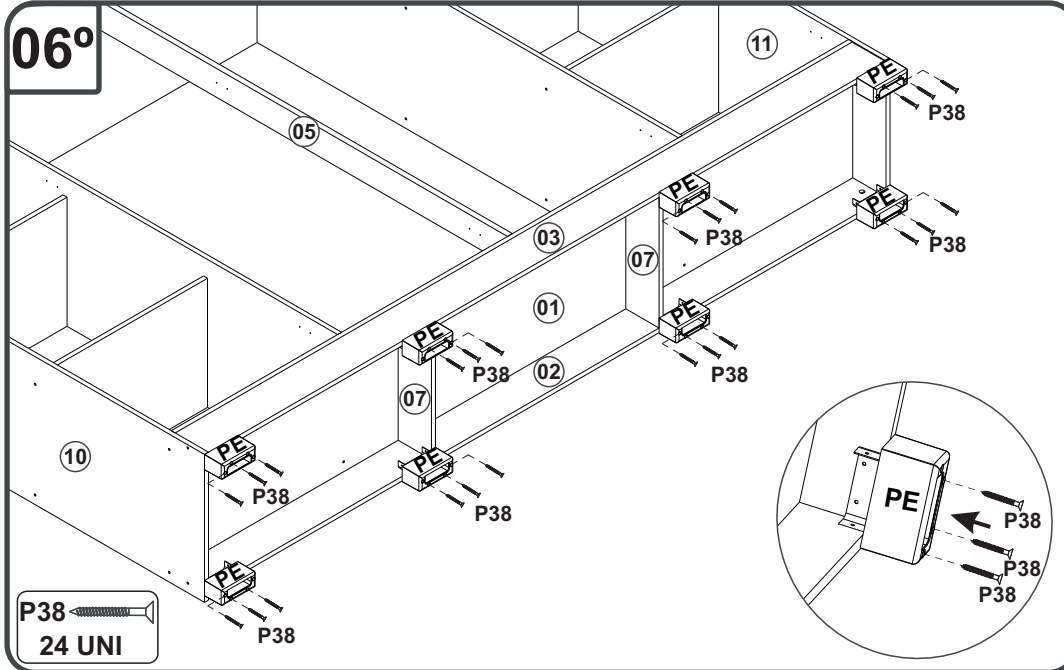

RP1803 - ROUPEIRO

Manual de Montagem
 Assembly Instructions
 Instrucción de Montaje



08°

P12 96 UNI

P41 16 UNI

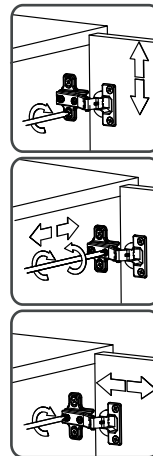
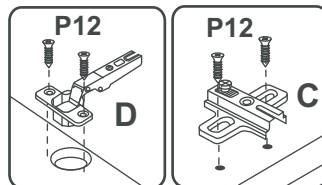
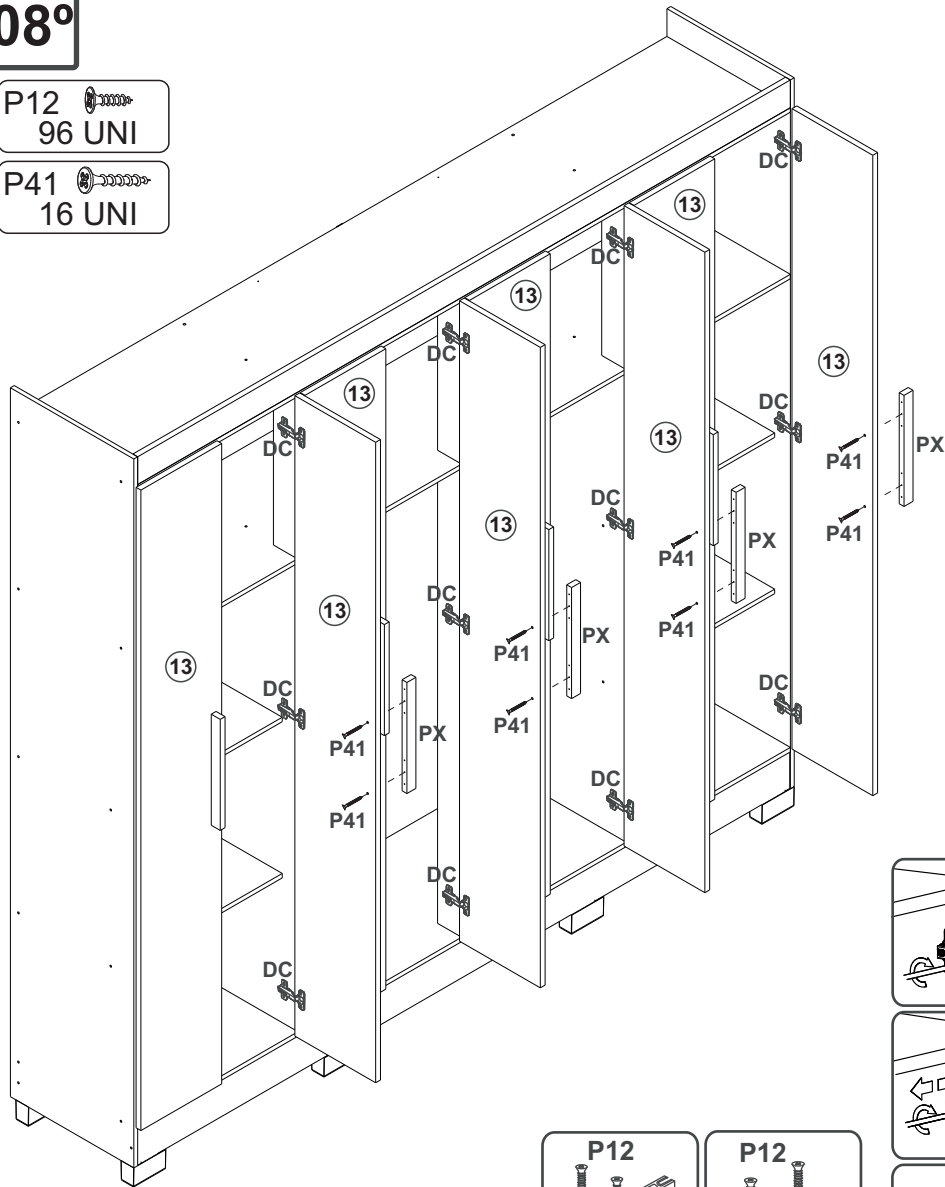

09°

PESO SUPORTADO/PESO SOPORTADO/ WEIGHT SUPPORTED

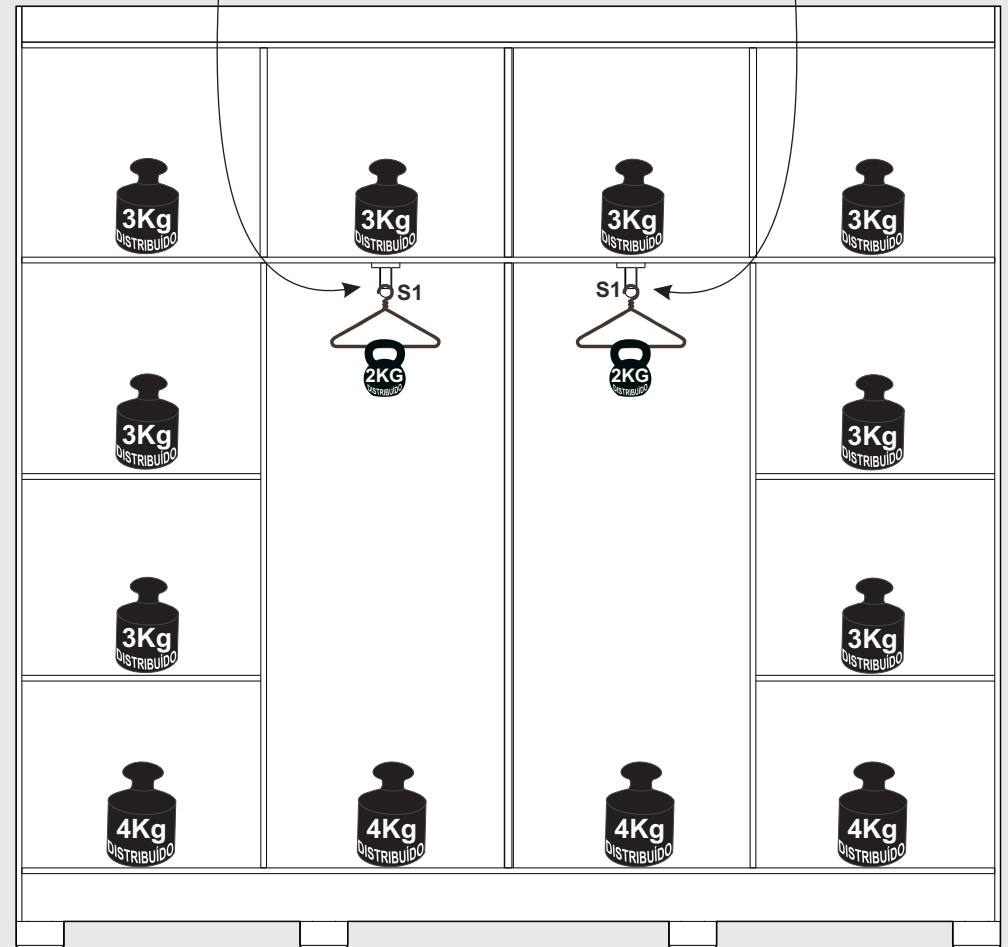
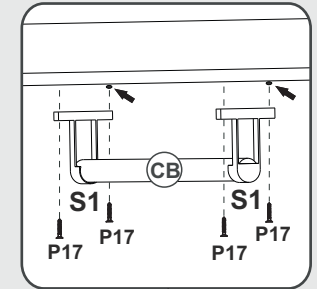
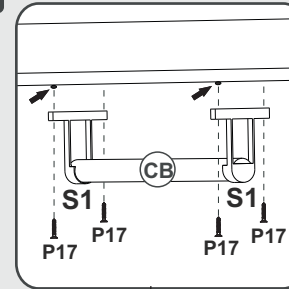

RP1803 - ROUPEIRO

Manual de Montagem
Assembly Instructions
Instrucción de Montaje

decibal[®]
móveis

Relação de Peças/ Relación de Piezas/Parts List

N°	CÓDIGO/CODE	DESCRIÇÃO/DESCRIPCIÓN/DESCRIPTION	QTD/CANT	VOL.	
1	0569288	BASE INF	2036X385X12MM	1	1
2	0569282	RODAPE TRS/ZÓCALO/BASEBOARD	2036X100X12MM	1	1
3	0569283	RODAPE FRT/ZÓCALO/BASEBOARD	2036X100X12MM	1	1
4	0569285	RODAFORRO	2036X75X15MM	1	1
5	0569286	PILASTRA/PILASTER	1266X75X15MM	1	1
6	0569292	PILASTRA SUP/PILASTER	438X75X15MM	3	1
7	0569293	RODAPÉ INT/ZÓCALO/BASEBOARD	340X100X12MM	2	1
8	0569289	PRATELEIRA/ESTANTE/SHELF	500X336X12MM	4	1
9	0569290	DIVISORIA/DIVISOR/DIVIDER	1266X385X12MM	2	1/2
10	0569281	LATERAL ESQ/LATERAL/SIDE	1915X385X12MM	1	1
11	0569287	LATERAL DIR/LATERAL/SIDE	1915X385X12MM	1	1
12	0569280	BASE MEIO SUP	2036X385X12MM	2	1
13	0569284	PORTA/PUERTA/DOOR	1730X252X15MM	8	2
14	0569294	COSTA/REVÉS/BACK	1283X516X2,8MM	2	2
15	0569295	COSTA MEIO/REVÉS/BACK	1283X508X2,8MM	2	2
16	0569296	COSTA SUP/REVÉS/BACK	1024X452X2,8MM	2	2

Escala (N/A)

LEGENDA	DESCRIÇÃO/DESCRIPCIÓN/DESCRIPTION	CÓDIGO	QUANT.
CB	 CABIDEIRO/ROLIZO PERCHA/ROD FOR HANGERS 324 MM	10323	02

ATENÇÃO!!!! montadores e consumidores
* Ajustar o torque da parafusadeira para não danificar as peças escareando o parafuso *

ATENCIÓN!!!! montadores e consumidores
* Ajuste el torque del destornillador para no dañar las piezas avallanando el tornillo *

ATTENTION!!!! assemblers and consumers
* Adjust the torque of the screwdriver so as not to damage the parts by countersinking the screw *

Ferramentas necessárias
Necessary tools
Herramientas necesarias

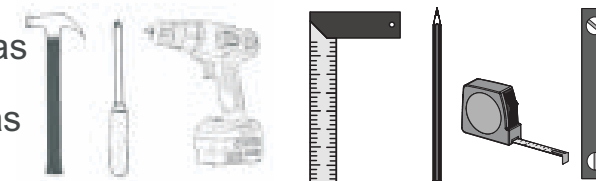

www.decibal.com.br

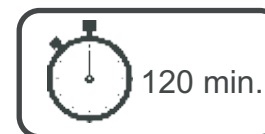

120 min.



2 montador
2 ajustador
2 Fitter

ATENÇÃO!!!! montadores e consumidores

* Para limpar o móveis utilize somente um pano úmido (umedecido em água pura ou água com sabão neutro). Depois, passe um pano seco. Evite a umidade excessiva.

* Evite usar álcool, água sanitária, detergente e outros produtos químicos, mesmo diluídos em água. Não utilize produtos abrasivos de nenhuma espécie

ATENCIÓN!!!! montadores e consumidores

* Para limpiar el mueble utilice solamente un paño húmedo (humedecido con agua limpia o con un jabón suave).

Acontinuación, utilice un paño seco. Evite el exceso de humedad.

* Evite uso de alcohol, hipoclorido solución basada, detergente y otros productos químicos, mismo diluídos en agua. No utilice productos abrasivos de ningún tipo.

ATTENTION!!!! assemblers and consumers

*To clean the furniture, use only a damp cloth (humidify it only in pure water ou water and neutral soap).After, use a dry cloth.Avoid excessive humidity.

*Avoid using alcohol, bleach, detergent and other chemical products, even diluted in water. Do not use any kind of abrasive cleaning agents to clean the furniture.









The use of such products may jeopardize the ?nal characteristics of the furniture.

RP1803 - ROUPEIRO









Manual de Montagem
Assembly Instructions
Instrucción de Montaje

decibal[®]
móveis

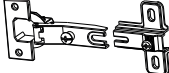
Escala (1:1)

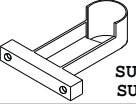
LEGENDA	DESCRIÇÃO/DESCRIPCIÓN/DESCRIPTION	CÓDIGO	QUANT.
P7	 PARAFUSO/TORDILHO/SCREW 4X45	01318	04
P12	 PARAFUSO/TORNILLO/SCREW 3,5X13	09927	142
P17	 PARAFUSO/TORNILLO/SCRE 4X22	10178	08
P38	 PARAFUSO/TORNILLO/SCREW 3,5X40	12425	62
P41	 PARAFUSO/TORNILLO/SCREW 3,5X35	13181	16
Pr1	 PREGO/CLAVO/NAIL 10X10	01330	110
B	BUCJA/BUJE/BUCHING 	02734	04
C2	 CAVILHA/TARUGO/DOWEL 6X30 MM	01211	20
C3	 CAVILHA/TARUGO/DOWEL 6X50 MM	01212	06

Escala (N/A)

LEGENDA	DESCRIÇÃO/DESCRIPCIÓN/DESCRIPTION	CÓDIGO	QUANT.
CL	 COLA/PEGAMENTO/GLUE	01213	01
ET	 ETIQUETA LOGO DECIBAL/LABEL DECIBAL	01312	01
Ct1	 CANTONEIRA/PIEZA L/SHEET	03077	23
DC	 DOBRADIÇA/BISAGRA/HINGE D=26mm C=5mm	01268	24
FX	 FIXADOR COSTA/FIJADOR FONDO/FIXER COAST	01331	38
S1	 SUPORTE CABIDEIRO/SOPORTE PERCHERO SUPPORT TO HANGER SUPPORT	04525	04
PE	 PE/PATA/FOOT 100X50X40MM	13084 CANELATO	08
PF	 PERFIL/PROFILE/PERFIL 1745MM	13191	01
PX	 PUXADOR/PEGADOR/HANDLE	0999999.0002	08

Medida em mm

