

Cristaleira Murano

Cristalera Murano / Murano Cabinet

Versão 1.1 / Versión 1.1 / 1.1 Version

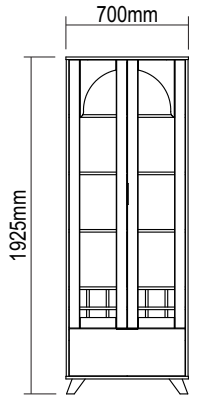

frente/frente/front

400mm



lateral/lado/side



Conservação e Limpeza - Conservación y Limpieza - Conservation and Cleaning

Não expor o produto ao sol, altas temperaturas e umidade. Não arrastar objetos sobre a superfície do móvel (ex.: TV, equipamentos eletrônicos, objetos decorativos...). Manter em local seco e arejado. Para a limpeza, utilizar um pano seco e macio. Não é necessário o uso de materiais abrasivos ou álcool.

No exponga el producto a la luz solar, las altas temperaturas y la humedad. No arrastre los objetos en la superficie de la unidad (por ejemplo, TV, equipos electrónicos, objetos de decoración ...). Mantener en un lugar fresco y seco. Para la limpieza, utilizar un paño seco y suave. El uso de materiales abrasivos o del alcohol no es necesario.

Do not expose the product to sunlight, high temperatures and humidity. Do not drag objects across the surface of the unit (TV, electronic equipments, decorative objects ...). Keep it in a cool and dry place. For cleaning, use a dry and soft cloth. Do not use abrasive materials or alcohol.

Garantia

Este certificado de Garantia é uma vantagem adicional oferecida ao consumidor, porém para que o mesmo tenha validade é imprescindível que seja apresentada a NOTA FISCAL de compra do produto.

Com este produto, a **Artely** tem como objetivo atender plenamente o proprietário-consumidor, proporcionando a garantia na forma aqui estabelecida, pelo período de três meses a partir da data da nota fiscal de compra. A **Artely** restringe a sua responsabilidade à substituição gratuita das peças defeituosas, em caso de defeitos ou avarias devidamente constatados como sendo de fabricação, durante a vigência desta garantia.

A **Artely** declara a garantia nula e sem efeito se o produto for alterado, adulterado, molhado ou consertado e ainda pela prática de montagem inadequada ou mau uso. Também será considerada nula em casos de força maior, como aqueles causados por agentes da Natureza (chuvas, incêndios, excesso de umidade, cupins,...) e eventos externos como objetos arrastados sobre a superfície do móvel (ex.: TV, DVD, aparelho de som, objetos decorativos...).

Para exercer seus direitos de comprador é importante que antes de montar seu produto você leia com atenção as instruções de cada passo do manual de montagem que acompanha o móvel.

Caso o produto não esteja em conformidade, entre em contato com a loja onde efetuou a compra e faça sua reclamação, apontando os defeitos técnicos observados. Para agilizar o seu atendimento, tenha sempre em mãos o manual de montagem com os respectivos números das peças defeituosas, conforme descritas no manual.

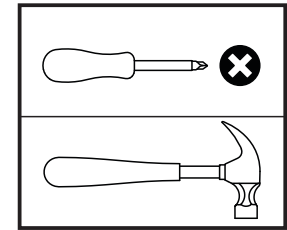
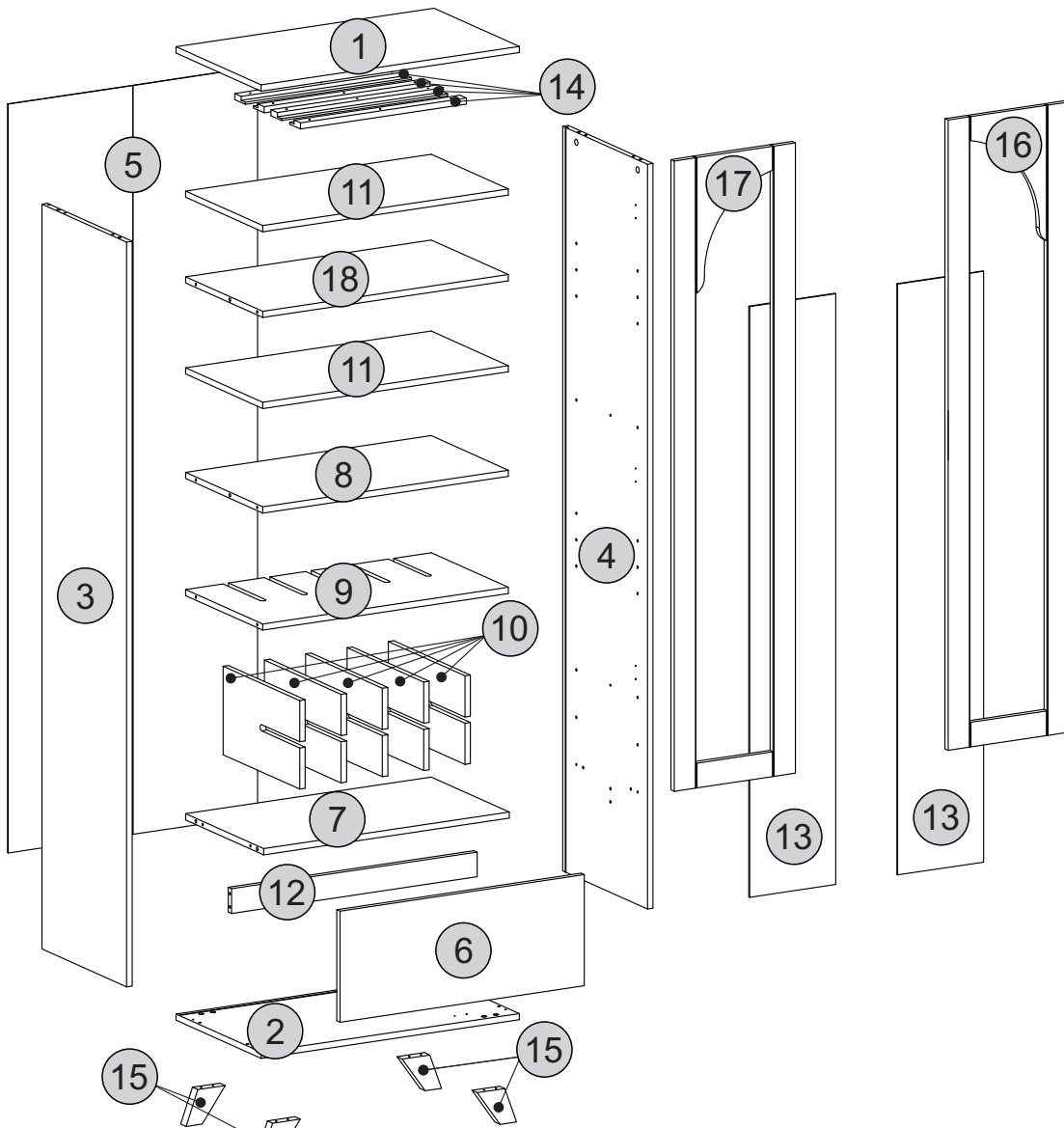







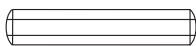

Ferramentas não fornecidas

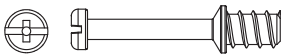
Descrição	Descripción	Description	Qtd
1-Tampo (700x400x15mm)	1-Tapa	1-Top	1
2-Base (700x400x15mm)	2-Base	2-Base	1
3-Lateral esquerda (1810x398x15mm)	3-Lado izquierdo	3-Left side	1
4-Lateral direita (1810x398x15mm)	4-Lado direito	4-Right side	1
5-Traseira (1820x676x3mm)	5-Trasero	5-Back	1
6-Porta inferior (662x270x15mm)	6-Puerta inferior	6-Lower door	1
7-Prateleira fixa inferior (666x366x15mm)	7-Anaqueil inferior fijo	7-Lower fixed shelf	1
8-Prateleira fixa (666x362x15mm)	8-Anaqueil fijo	8-Fixed shelf	1
9-Prateleira (666x362x15mm)	9-Anaqueil	9-Left panel	1
10-Divisão (360x215x15mm)	10-División	10-Division	5
11-Prateleira móvel (666x362x15mm)	11-Anaqueil móvil	11-Mobile shelf	2
12-Travessa (666x60x15mm)	12-Travesaño	12-Crosspiece	1
13-Vidro (1436x233x4mm)	13-Vidrio	13-Glass	2
14-Travessa porta taça (450x50x15mm)	14-Travesaño porta vasos	14-Cup holder crosspiece	4
15-Pé (117x70x25mm)	15-Pies	15-Foot	4
16-Porta direita (1532x329x15mm)	16-Puerta direita	16-Right door	1
17-Porta esquerda (1532x329x15mm)	17-Puerta izquierda	17-Left door	1
18-Prateleira fixa superior (666x362x15mm)	17-Anaqueil superior fijo	17-Upper fixed shelf	1

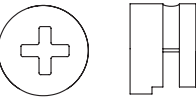
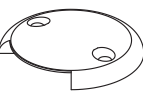
- O número na borda da peça corresponde ao manual.
- Para retirada do número usar Lustra-Móveis, Alcool em Gel ou Borracha.
 -El número en el borde de la pieza coincide con el manual.
 -Use una goma de borrar blanca, alcohol en gel o lustrador para muebles para eliminar los números.
 -The number on the edge of the piece matches the manual.
 -Use a White eraser, Alcohol Gel or Furniture Polish to remove the numbers.

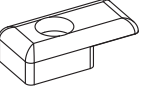
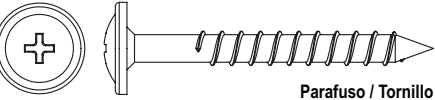
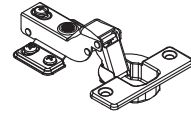
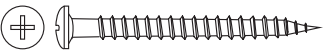
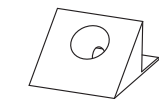
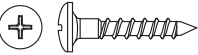
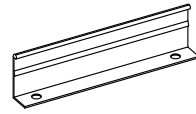
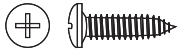
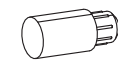
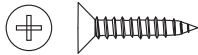
Lista de Materiais Lista de Materiales/ Hardware List

A		Cavilha / Tarugo / Dowel Ø6x30mm	28	K		Produto Moldado / Silicona / Silicone 8mm	06
B		Minifix / Minifix / Minifix Ø7x30mm	12	L		Sapata Fixa / Pata Fija / Fixed Foot Ø2,0x10mm Plástico	04
C		Tambor / Tambor / Minifix Cam Ø15x12mm	12	M		Suporte Canto Vidro /	08
D		Tapa furo adesivo / Adhesivo / Hole Cover Ø18mm	22	N		Suporte Vidro /	08
E		Parafuso / Tornillo / Screw Ø5,0x40mm CF	08	O		Dobradiça / Bisagra / Hinge /	08
F		Parafuso / Tornillo / Screw / Ø3,5x40mm CP	04	P		Suporte Triangular /	16
G		Parafuso / Tornillo / Screw / Ø4,0x20mm CP	12	Q		Puxador Tirador / Handle	02
H		Parafuso Tornillo / Screw Ø4x14mm CP	48	R		Pino / Alfiler / Pin	08
I		Parafuso / Tornillo / Screw Ø3,5x16mm CC Metal - Cabeça Philips	16				
J		Parafuso / Tornillo / Screw Ø3,5x12mm CC Metal - Cabeça Philips	28				

DICAS PARA FIXAR MINIFIX

TIP TO FASTEN THE MINIFIX
PISTA PARA ARREGLAR EL MINIFIX

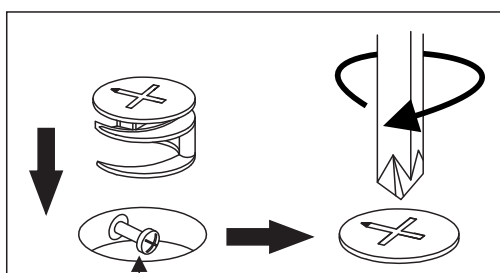

Cabeça do parafuso precisa estar no centro

La cabeza del tornillo debe estar en el centro

Screw head has to be in the center

Parafuso Minifix

Tornillo minifix/Minifix screw

Fixe o parafuso até o ressalto encostar na superfície da peça (veja o exemplo abaixo).

Tighten the screw until its overhang part lean on the piece surface (see the example below).

Fije el tornillo hasta que su parte sobresaliente toque la superficie de la pieza (vea el ejemplo abajo).

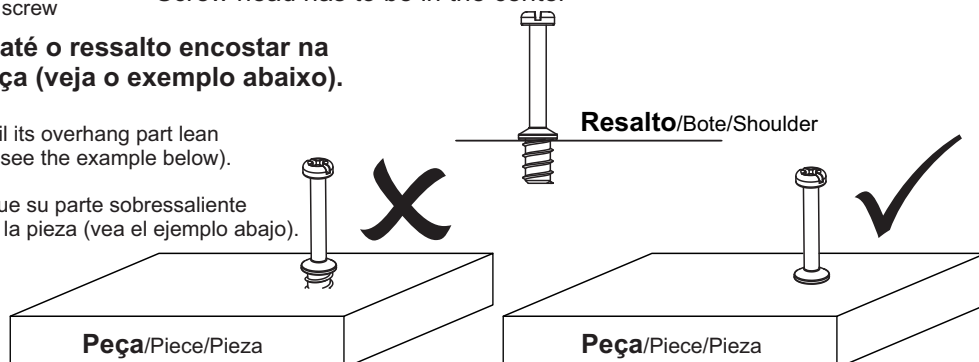

Passo 1

Paso/Step

PEÇA

Piece/Pieza

1 - TAMPO x1

14 - TRAVESSA PORTA TAÇA x4

FERRAGEM

Hardware/Herraje

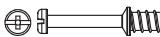
B  04

D  12

G  12

FERRAMENTA

Tool/Herramienta

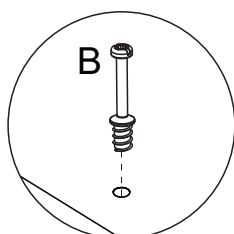
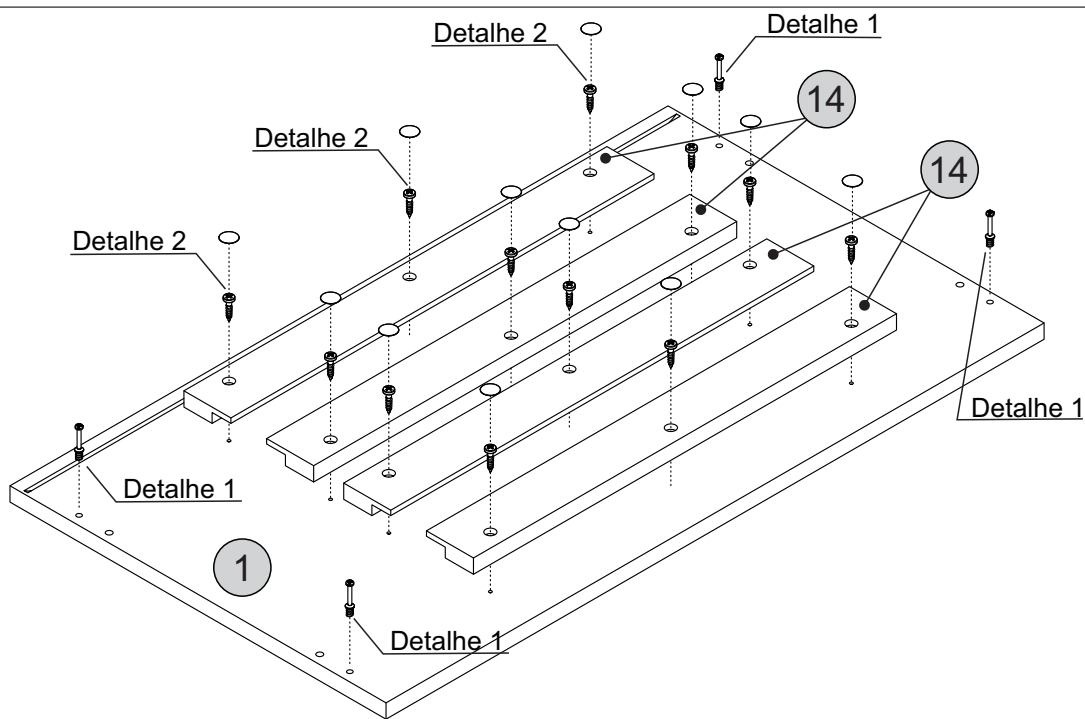
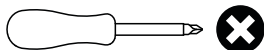

Detalhe 1
Detail/Detalle

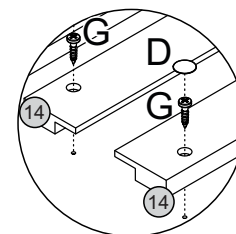
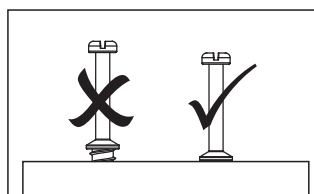

Detalhe 2
Detail/Detalle

Passo 2

Paso/Step

PEÇA

Piece/Pieza

2 - BASE x1

15 - PÉ x4

FERRAGEM

Hardware/Herraje

D  08

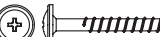
E  08

L  04

FERRAMENTA

Tool/Herramienta

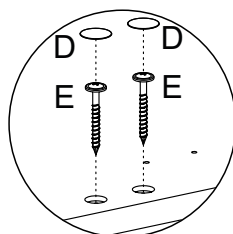
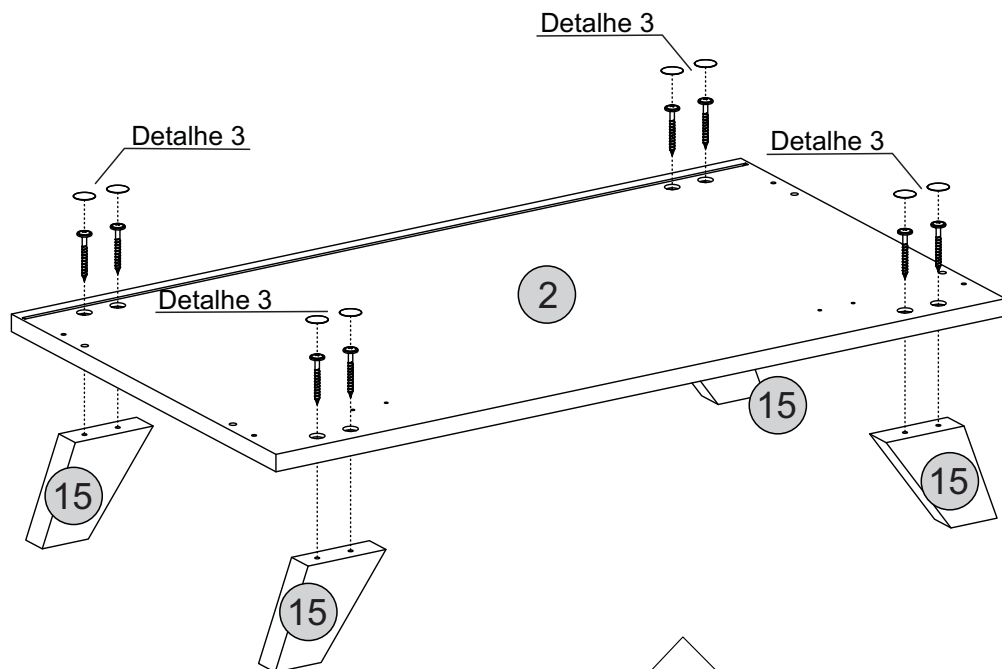
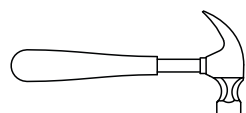
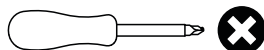

Detalhe 3
Detail/Detalle

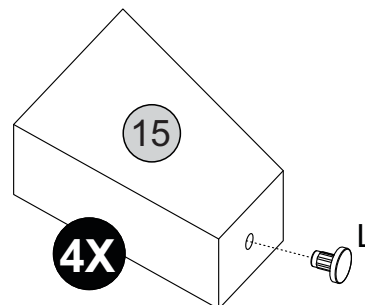

Passo 3

Paso/Step

PEÇA
Piece/Pieza

3 - LATERAL ESQUERDA x1

FERRAGEM
Hardware/Herraje

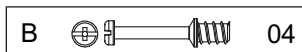
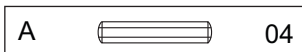

FERRAMENTA
Tool/Herramienta

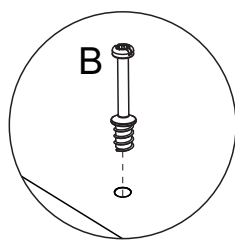
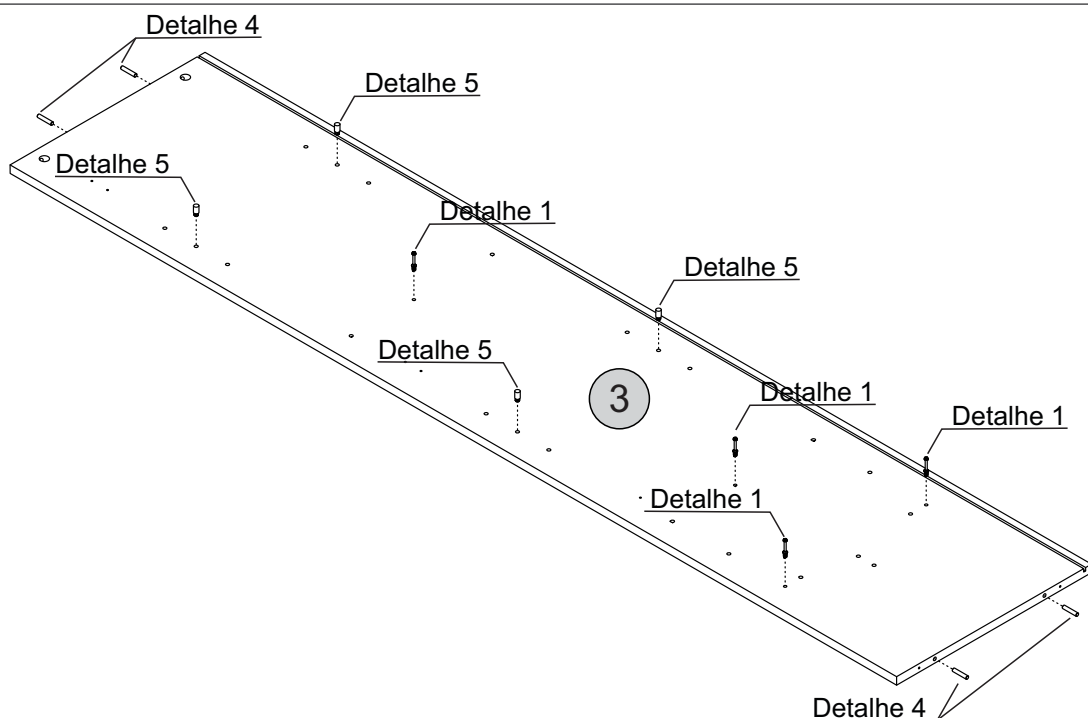
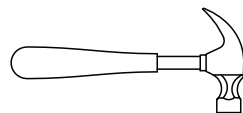
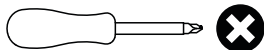

Detalhe 1
Detail/Detalle

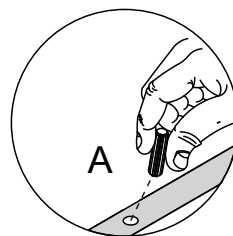
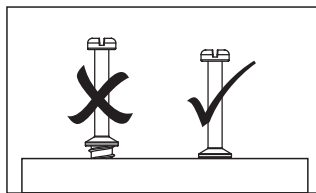

Detalhe 4
Detail/Detalle

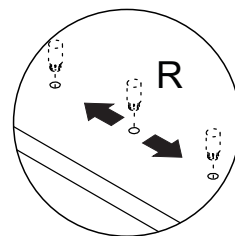

Detalhe 5
Detail/Detalle

Passo 4

Paso/Step

PEÇA
Piece/Pieza

4 - LATERAL DIREITA x1

FERRAGEM
Hardware/Herraje

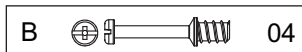
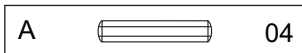

FERRAMENTA
Tool/Herramienta

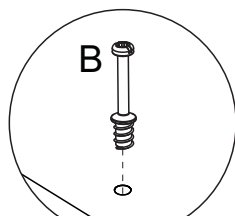
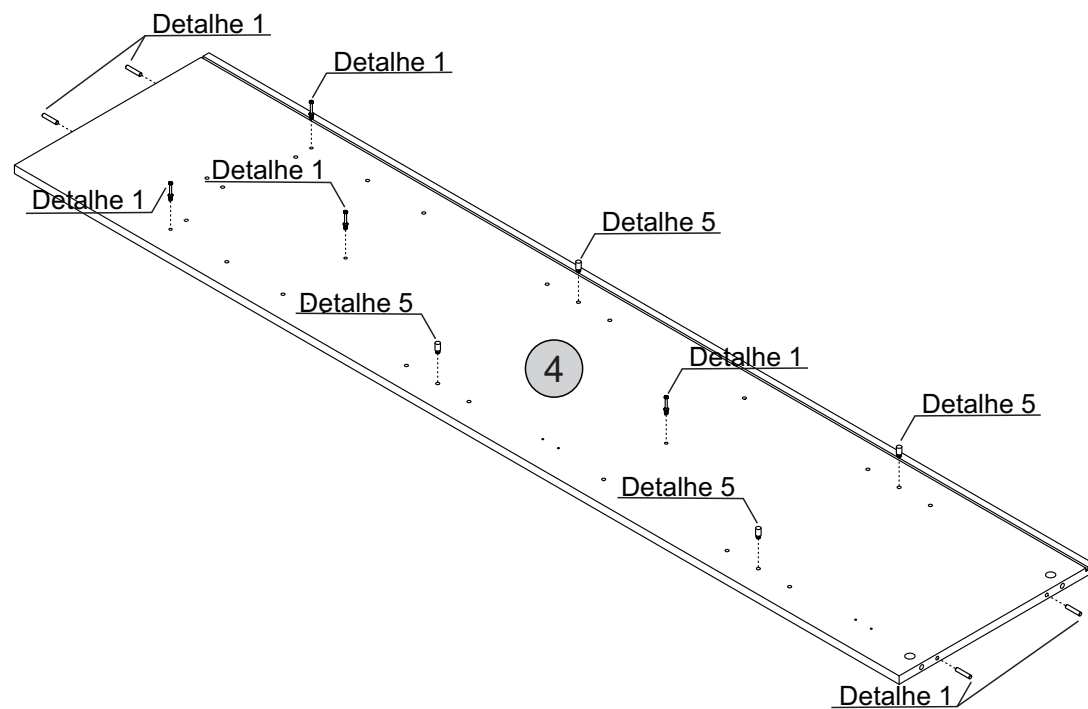
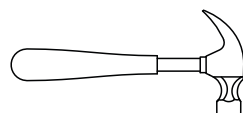
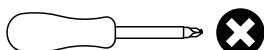

Detalhe 1
Detail/Detalle

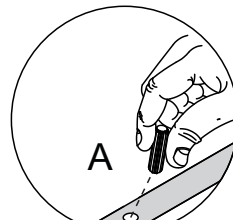
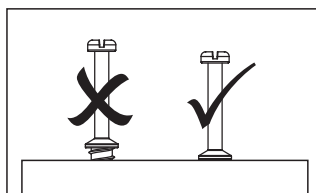

Detalhe 4
Detail/Detalle

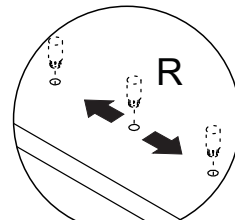

Detalhe 5
Detail/Detalle

Passo 5

Paso/Step

PEÇA
Piece/Pieza

6 - PORTA x1

FERRAGEM
Hardware/Herraje

H  04

J  02

K  02

O  02

Q  01

FERRAMENTA
Tool/Herramienta

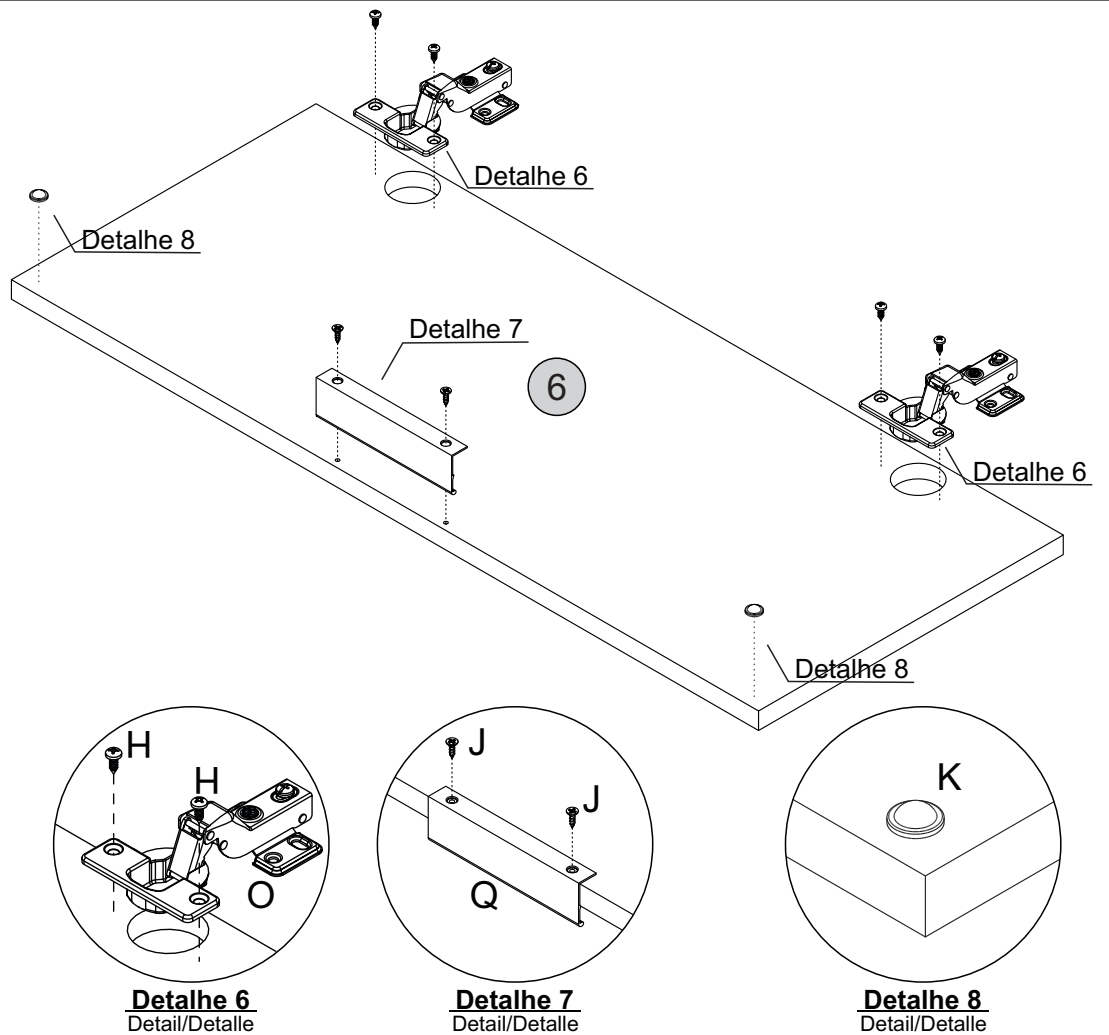
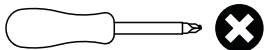

Passo 6

Paso/Step

PEÇA
Piece/Pieza

7 - PRATELEIRA FIXA INF. x1

8 - PRATELEIRA FIXA x1

18 - PRATELEIRA FIXA SUP. x1

FERRAGEM
Hardware/Herraje

A  12

FERRAMENTA
Tool/Herramienta

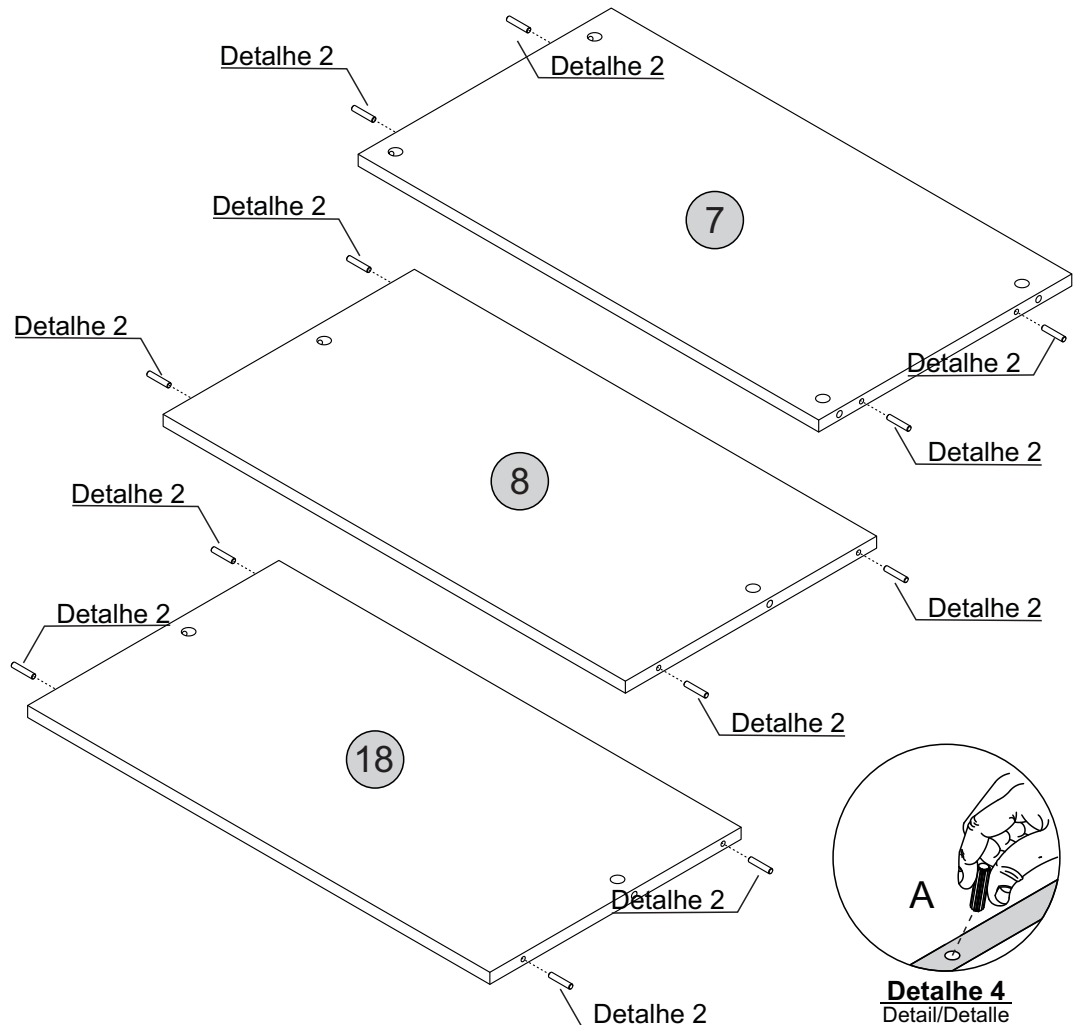
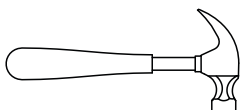

Passo 7

Paso/Step

PEÇA
Piece/Pieza

9 - PRATELEIRA x1

12 - TRAVESSA x1

FERRAGEM
Hardware/Herraje

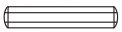
A  08

FERRAMENTA
Tool/Herramienta

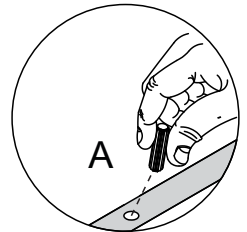
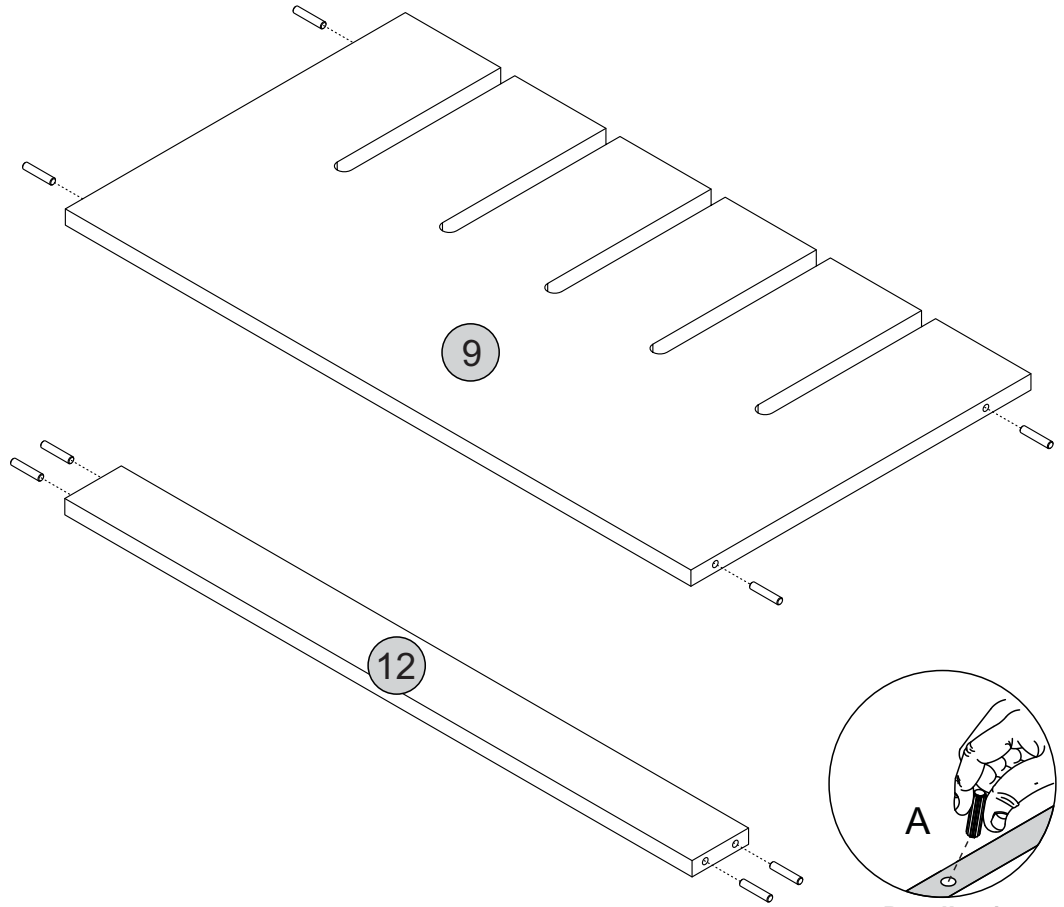
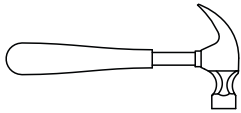

Detalhe 4
Detail/Detalle

Passo 8

Paso/Step

PEÇA
Piece/Pieza

3 - LATERAL ESQUERDA x1

8 - PRATELEIRA FIXA x1

18 - PRATELEIRA FIXA SUP. x1

FERRAGEM
Hardware/Herraje

C   02

D  01

FERRAMENTA
Tool/Herramienta

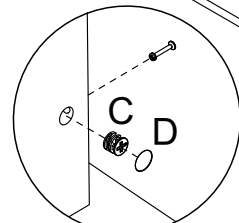
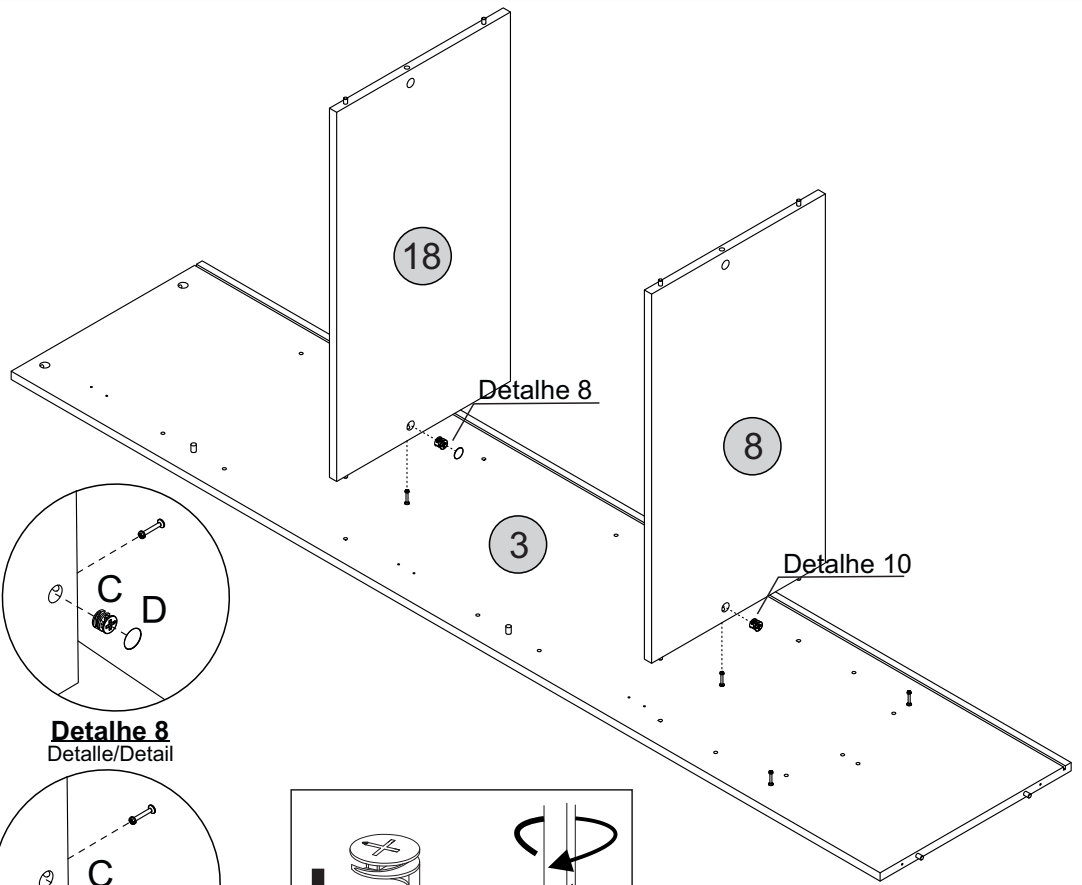
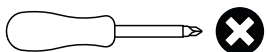

Detalhe 8
Detalle/Detail

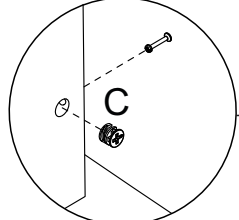

Detalhe 10
Detalle/Detail

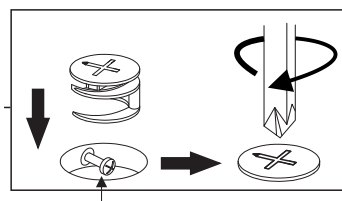

La cabeza del tornillo debe estar en el centro
Screw head has to be in the center

Passo 9

Paso/Step

PEÇA
Piece/Pieza

9 - PRATELEIRA x1

10 - DIVISÃO x5

FERRAGEM
Hardware/Herraje

FERRAMENTA
Tool/Herramienta

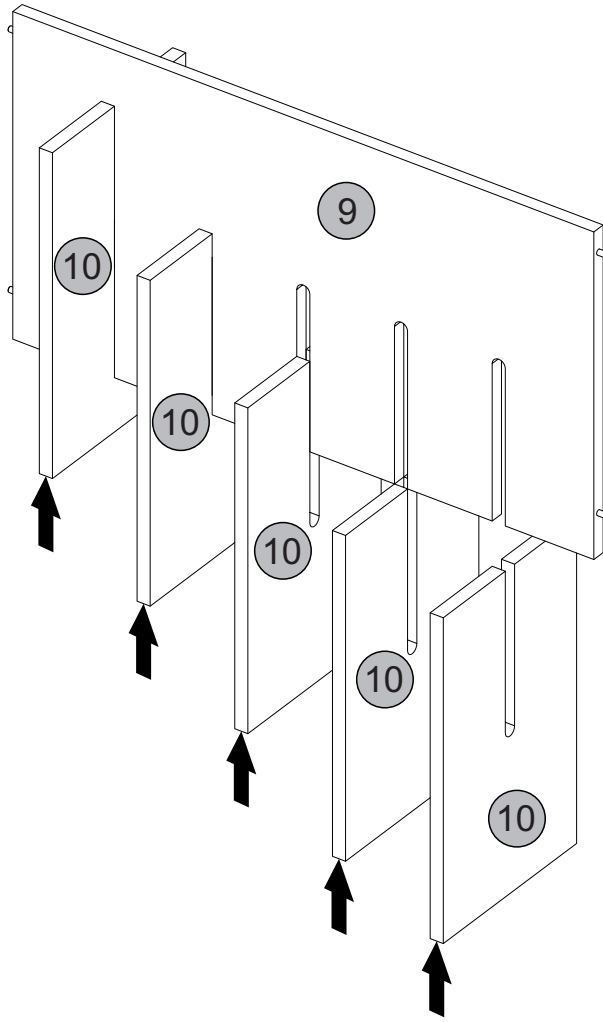

Passo 10

Paso/Step

PEÇA
Piece/Pieza

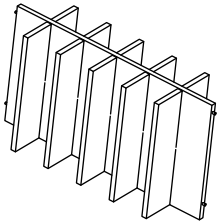
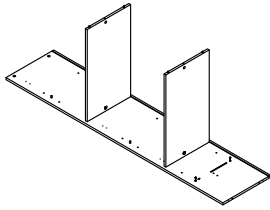

FERRAGEM
Hardware/Herraje

FERRAMENTA
Tool/Herramienta

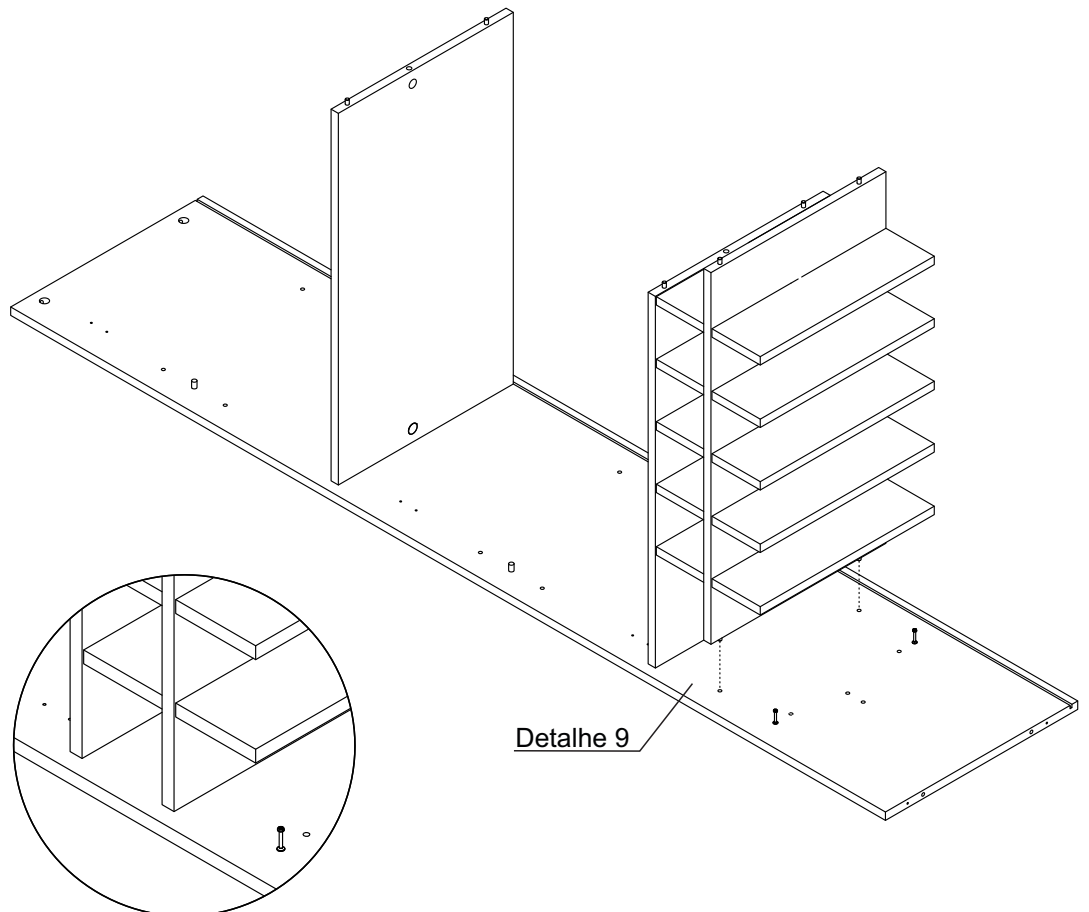

Detalhe 9
Detalle/Detail

Passo 11

Paso/Step

PEÇA
Piece/Pieza

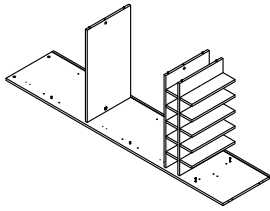

7 - PRATELEIRA FIXA INF. x1

12 - TRAVESSA x1

FERRAGEM
Hardware/Herraje

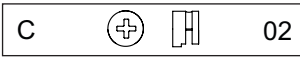

FERRAMENTA
Tool/Herramienta

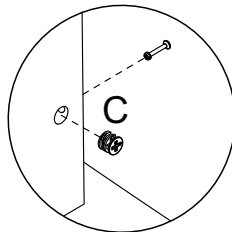
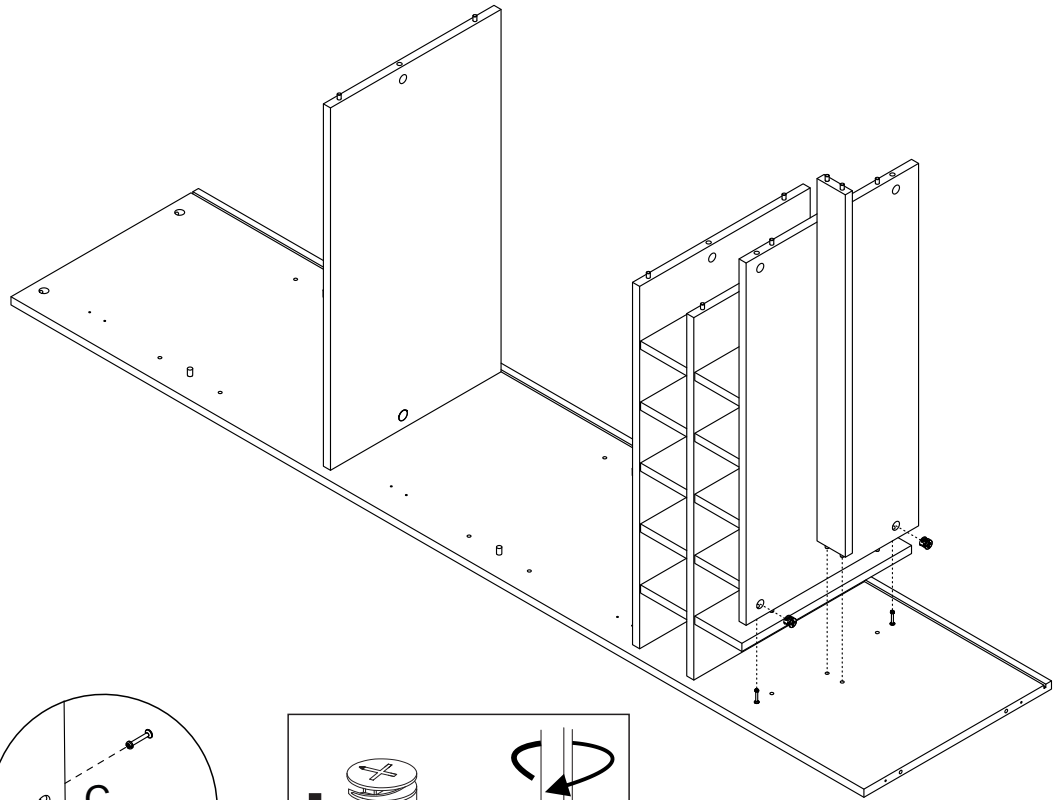
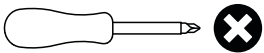

Detalhe 10
Detalle/Detail

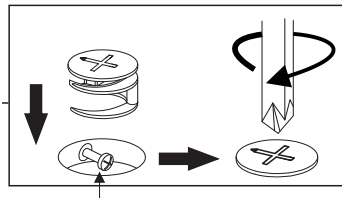

La cabeza del tornillo debe estar en el centro
Screw head has to be in the center

Passo 12

Paso/Step

PEÇA
Piece/Pieza

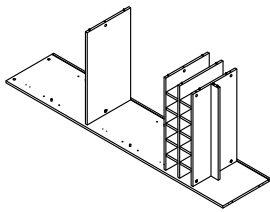

4 - LATERAL DIREITA x1

FERRAGEM
Hardware/Herraje

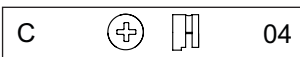

FERRAMENTA
Tool/Herramienta

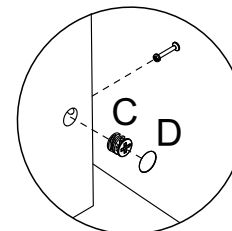
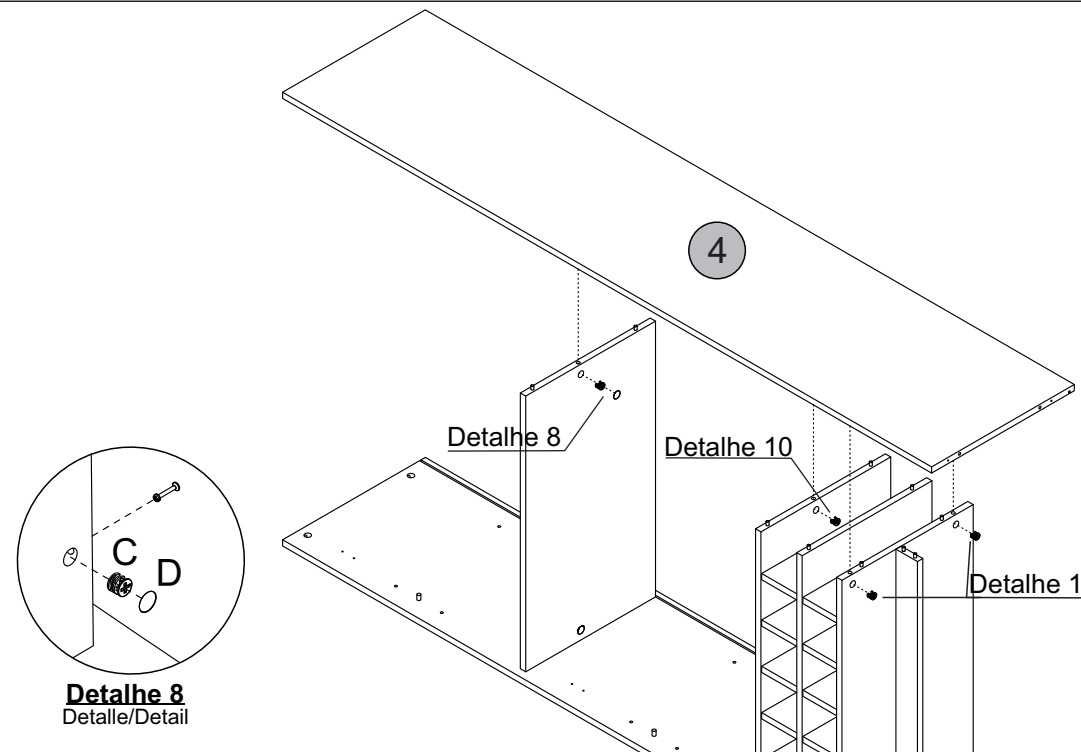
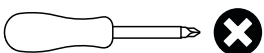

Detalhe 8
Detalle/Detail

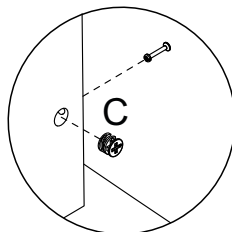

Detalhe 10
Detalle/Detail

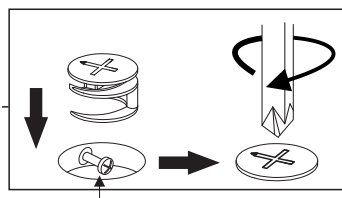

La cabeza del tornillo debe estar en el centro
Screw head has to be in the center

Passo 13

Paso/Step

PEÇA
Pieça/Pieza

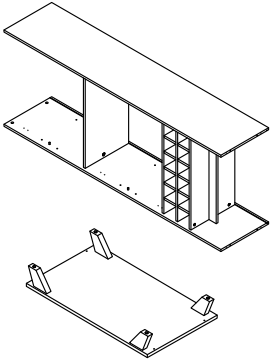

FERRAGEM
Hardware/Herraje

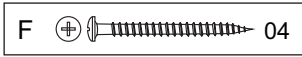

FERRAMENTA
Tool/Herramienta

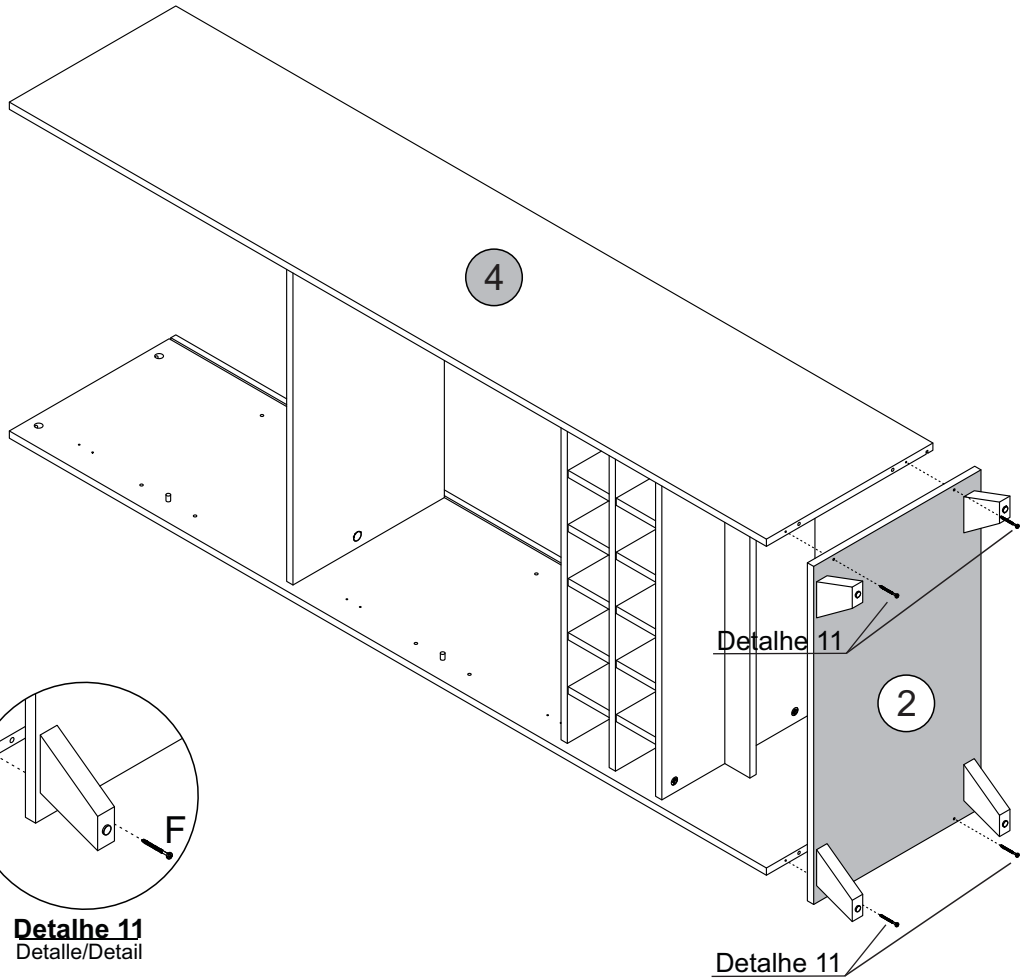
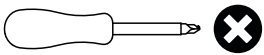

Detalhe 11
Detalle/Detail

Detalhe 11

Passo 14

Paso/Step

PEÇA
Pieza/Piece

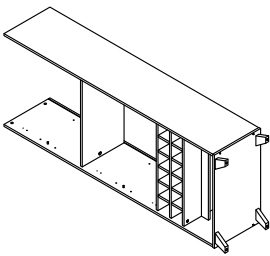

5 - TRASEIRA x1

FERRAGEM
Herraje/Hardware

FERRAMENTA
Herramienta/Tool

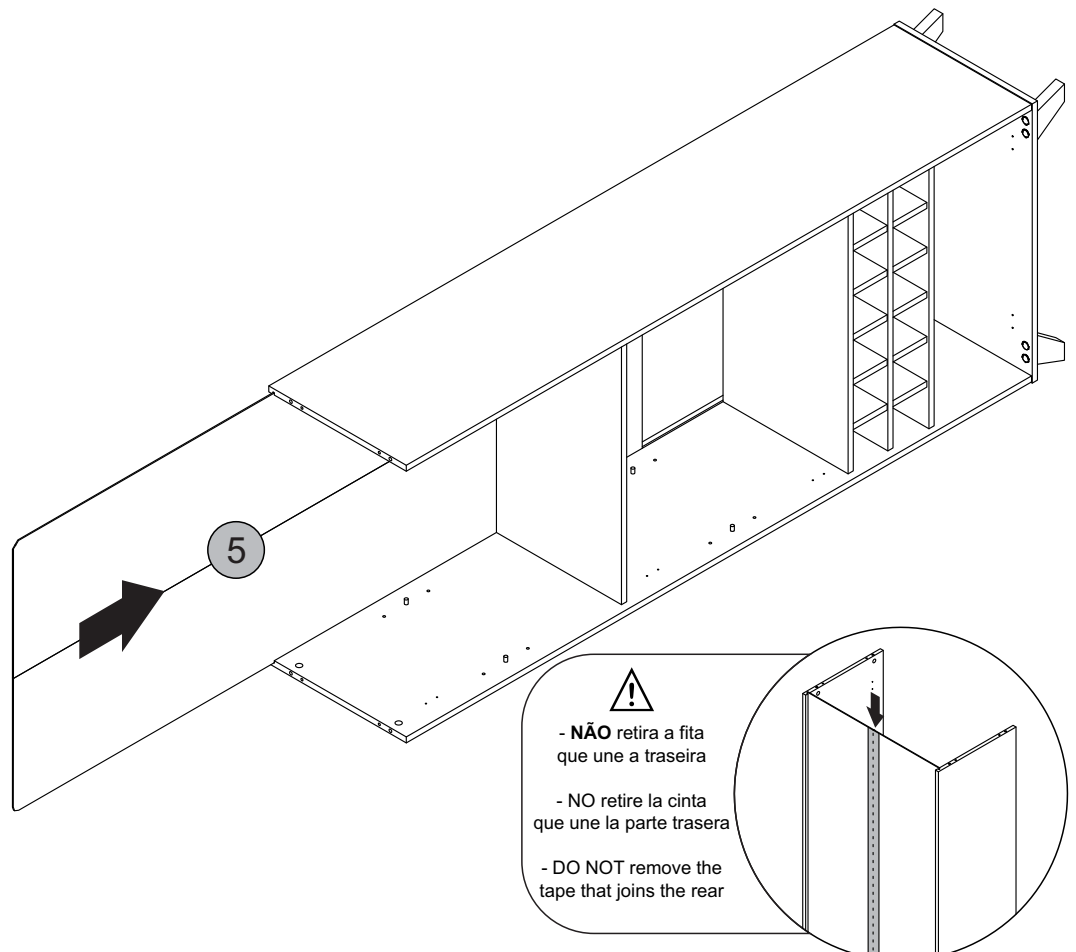

!
- NÃO retira a fita que une a traseira
- NO retire la cinta que une la parte trasera
- DO NOT remove the tape that joins the rear

Detalhe 11
Detalle/Detail

Passo 15

Paso/Step

PEÇA
Pieça/Pieza

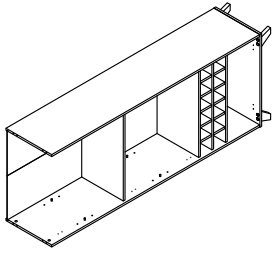

1 - TAMPO x1

FERRAGEM
Hardware/Herraje



FERRAMENTA
Tool/Herramienta

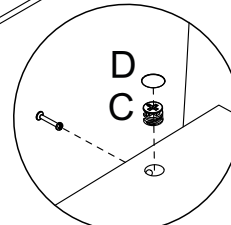
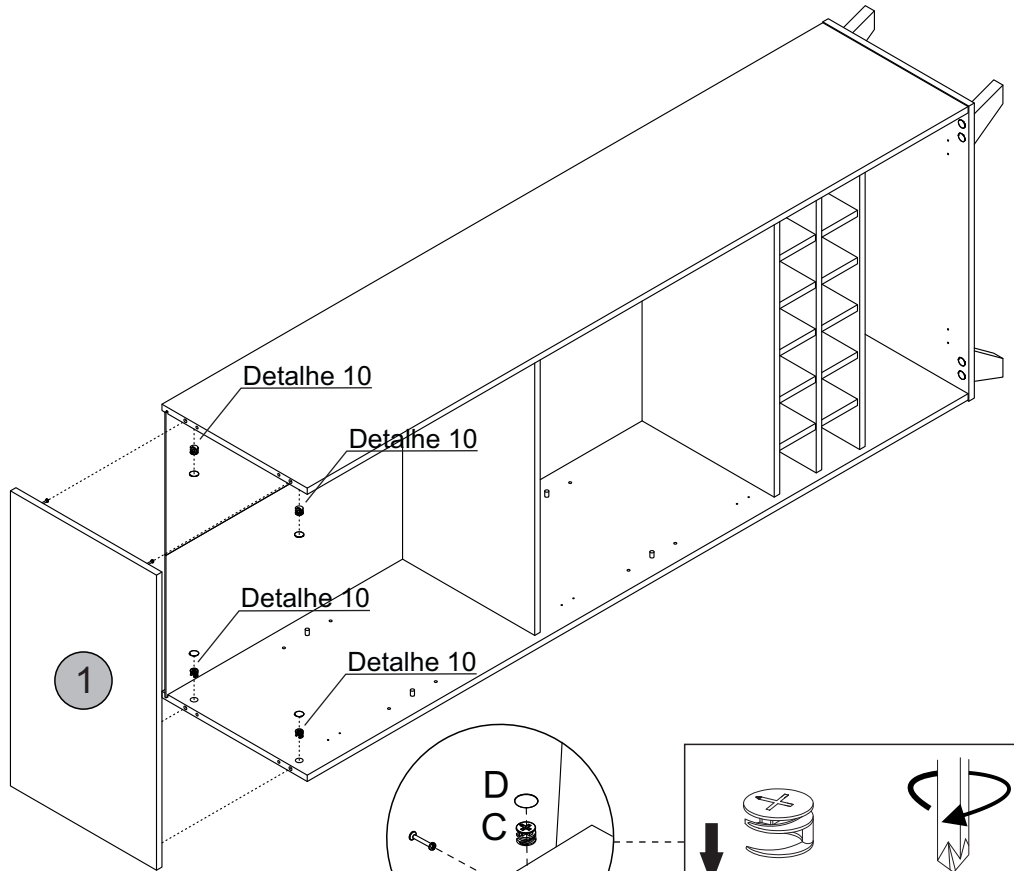
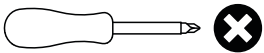

Detalhe 8
Detalle/Detail

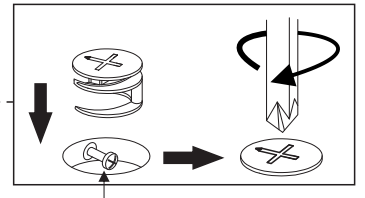

La cabeza del tornillo debe estar en el centro
Screw head has to be in the center

Passo 16

Paso/Step

PEÇA
Pieça/Pieza

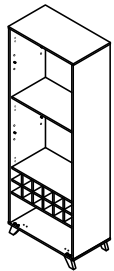

FERRAGEM
Herraje/Hardware

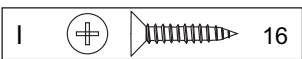

FERRAMENTA
Herramienta/Tool

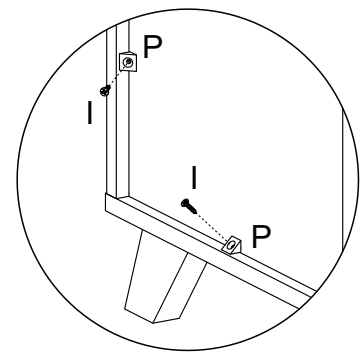
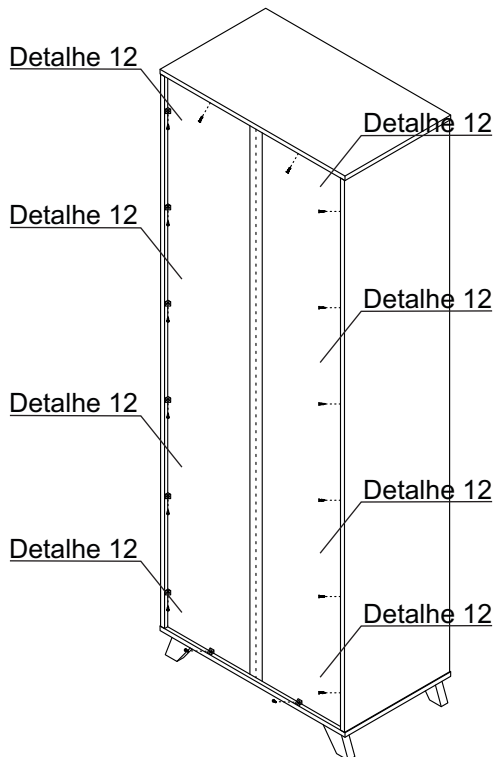
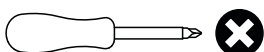

Detalhe 12
Detalle/Detail

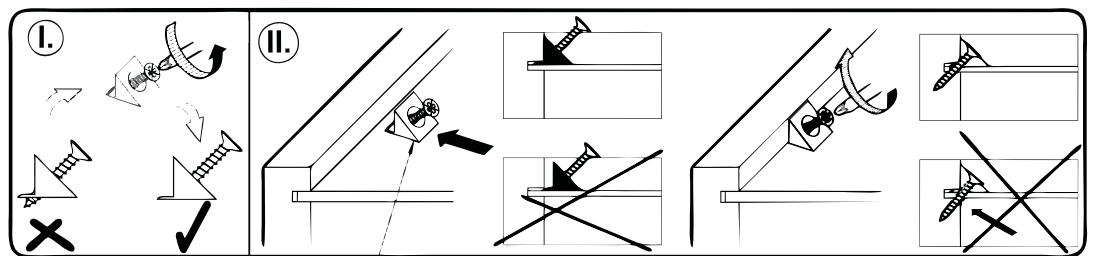

Passo 17

Paso/Step

PEÇA
Piece/Pieza

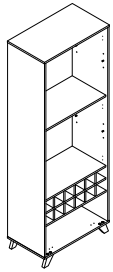

11 - PRATELEIRA x2

FERRAGEM
Hardware/Herraje

FERRAMENTA
Tool/Herramienta

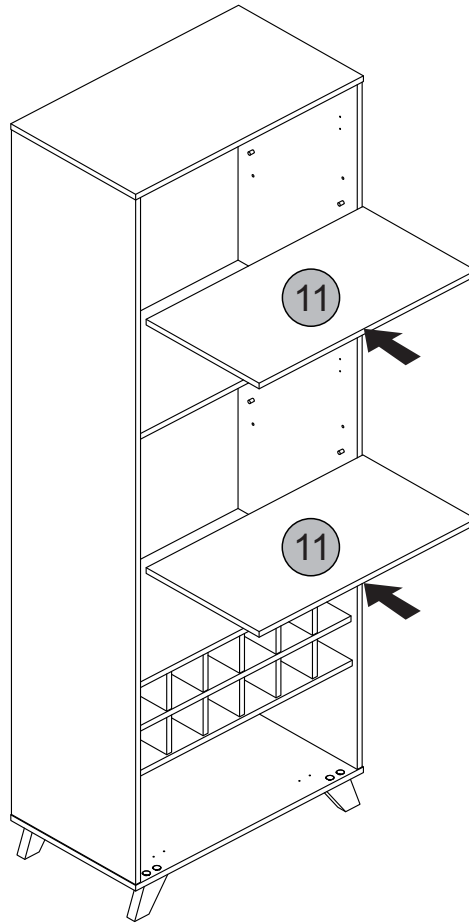

Passo 18

Paso/Step

PEÇA
Piece/Pieza

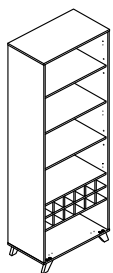

6 - PORTA INFERIOR x1

FERRAGEM
Hardware/Herraje

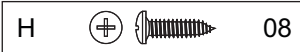

FERRAMENTA
Tool/Herramienta

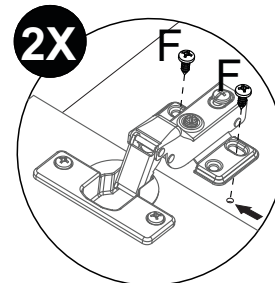
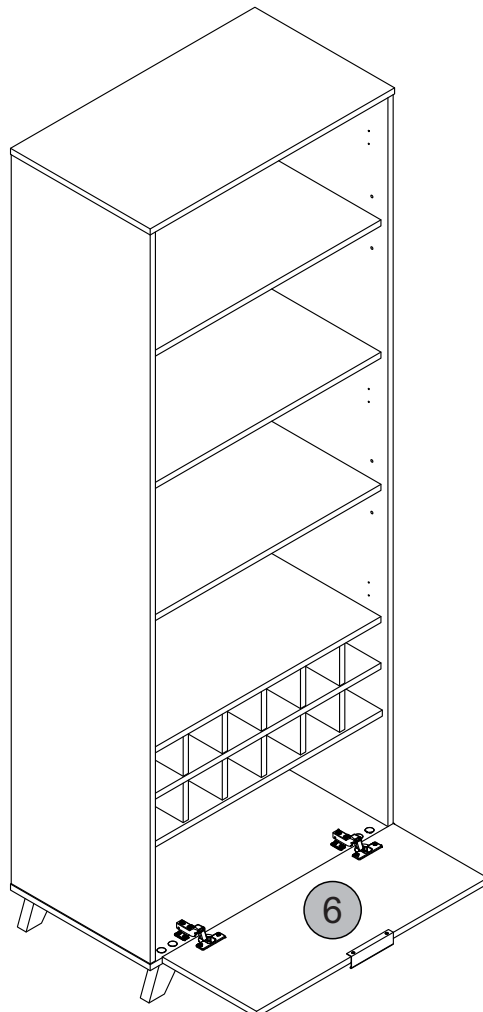
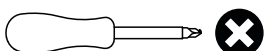

Passo A
Paso/Step

Ajustar porta.

Ajusta puerta. / Adjust door.

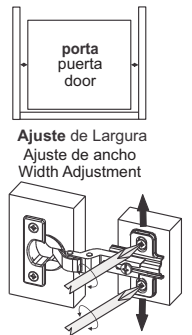

Ajuste de Largura
Ajuste de ancho
Width Adjustment

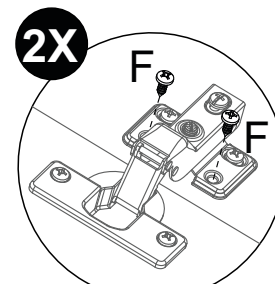

Passo B
Paso/Step

Fixa porta

arreglar puerta. / fix door.

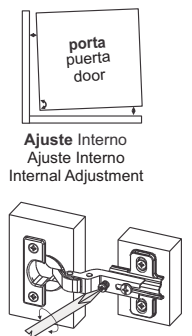

Ajuste Interno
Ajuste Interno
Internal Adjustment



Ajuste de Profundidade
Ajuste de profundidad
Depth Adjustment

Passo 19

Paso/Step

PEÇA
Piece/Pieza

16 - PORTA DIREITA x1

17 - PORTA ESQUERDA x1

FERRAGEM
Hardware/Herraje

H  12

O  06

FERRAMENTA
Tool/Herramienta

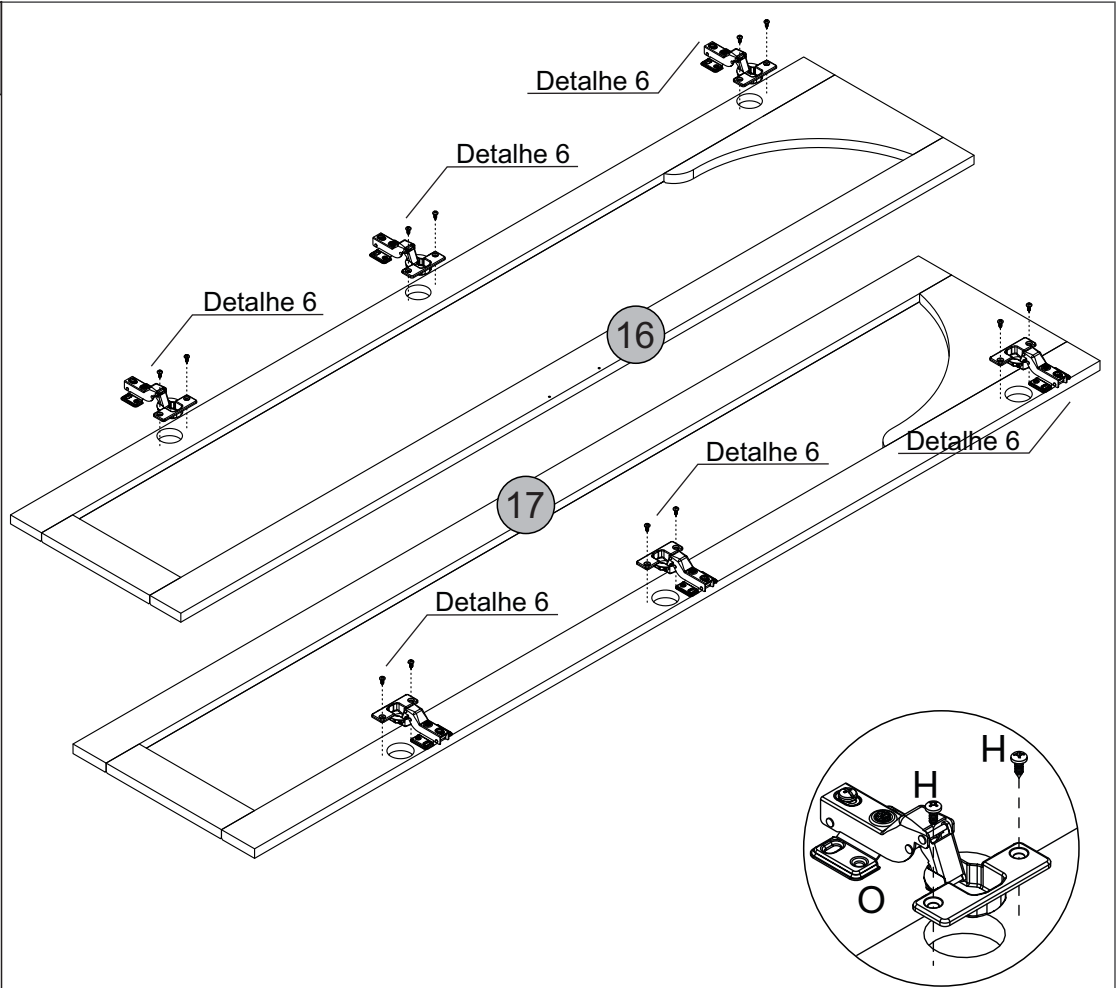
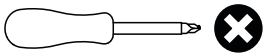

Detalhe 6
Detail/Detalle

Passo 20

Paso/Step

PEÇA
Piece/Pieza

13 - VIDRO x2

FERRAGEM
Hardware/Herraje

J  26

M  08

N  08

Q  01

FERRAMENTA
Tool/Herramienta

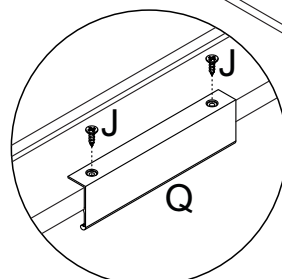
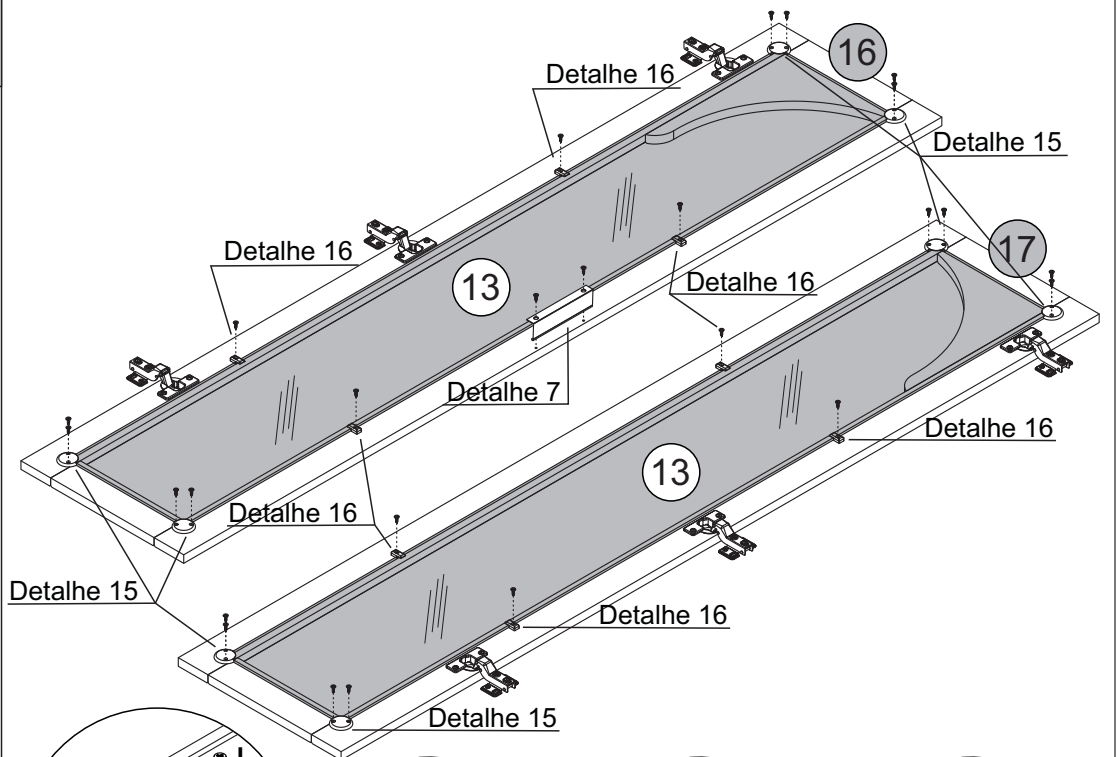
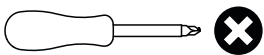

Detalhe 7
Detail/Detalle

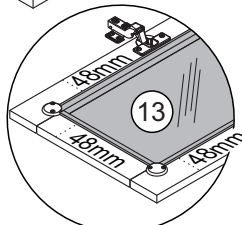

Detalhe 14
Detalle/Detail

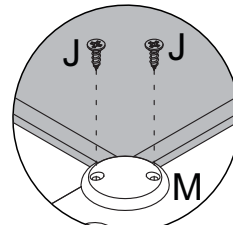

Detalhe 15
Detalle/Detail

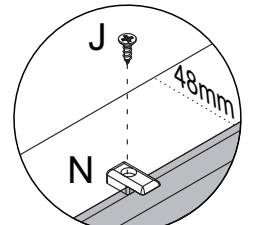

Detalhe 16
Detalle/Detail

Passo 21

Paso/Step

PEÇA
Piece/Pieza

16 - PORTA DIREITA x1

FERRAGEM
Hardware/Herraje

H  12

K  02

FERRAMENTA
Tool/Herramienta

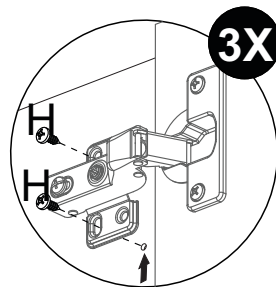
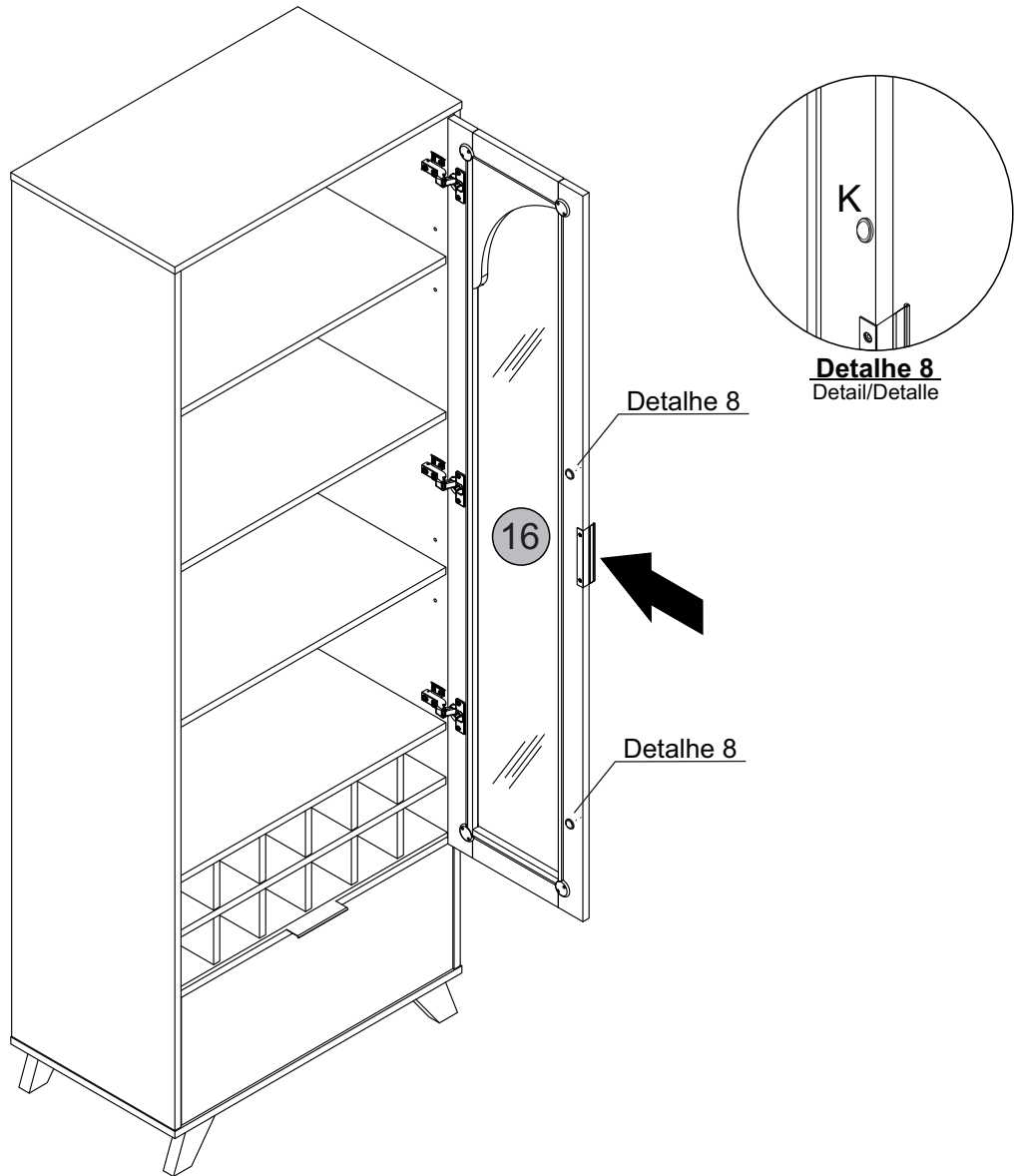
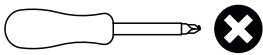

Passo A
Paso/Step

Ajustar porta.

Ajusta puerta. / Adjust door.

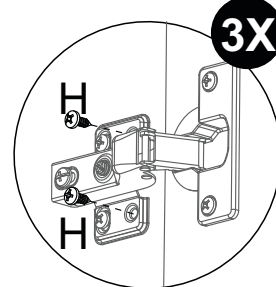

Passo B
Paso/Step

Fixa porta

arreglar puerta. / fix door.

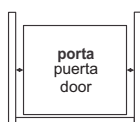

Ajuste de Largura
Ajuste de ancho
Width Adjustment

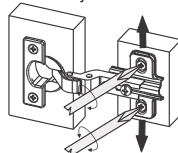

Ajuste Interno
Ajuste Interno
Internal Adjustment

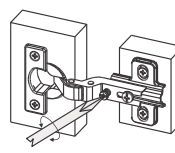

Ajuste de Profundidade
Ajuste de profundidad
Depth Adjustment

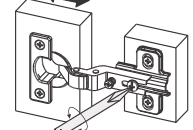

Passo 22

Paso/Step

PEÇA
Pieze/Pieza

17 - PORTA ESQUERDA x1

FERRAGEM
Hardware/Herraje

H  12

K  02

FERRAMENTA
Tool/Herramienta

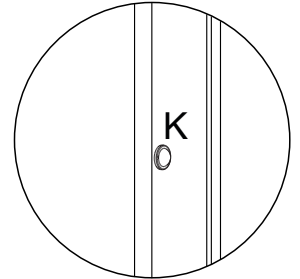
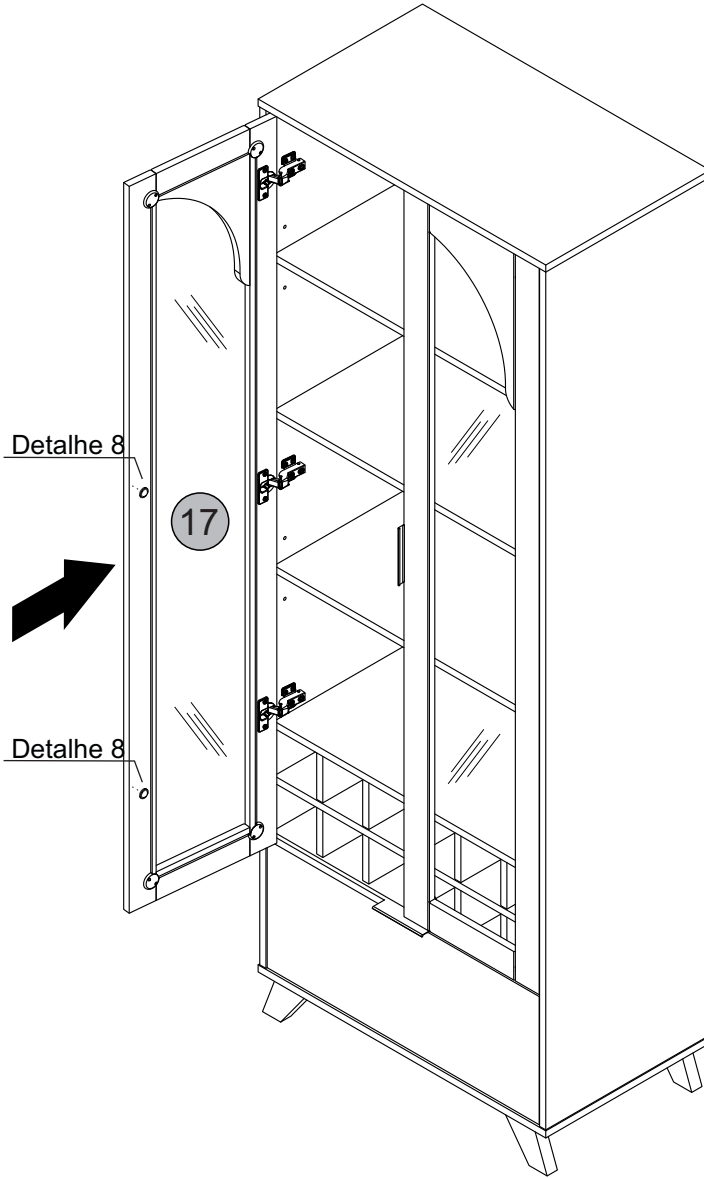
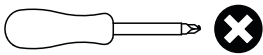

Detalhe 8
Detail/Detalle

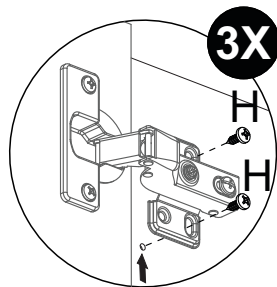

Passo A
Paso/Step

Ajustar porta.

Ajusta puerta. / Adjust door.

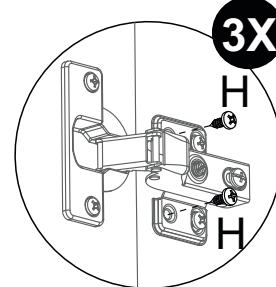

Passo B
Paso/Step

Fixa porta

arreglar puerta. / fix door.



Ajuste de Largura
Ajuste de ancho
Width Adjustment

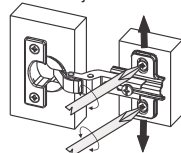

Ajuste Interno
Ajuste Interno
Internal Adjustment

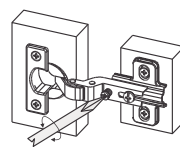

Ajuste de Profundidade
Ajuste de profundidade
Depth Adjustment

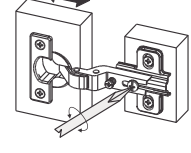



Parabéns, você montou seu móvel! Agora é só decorar sua casa e aproveitar!

Queremos ver como ficou o móvel Artely do seu jeito... Marque a gente com a #meuartely. Ficaremos felizes em compartilhar!

Ah, e se tiver qualquer dúvida, sugestão ou comentário, entra em contato com a gente pelo nosso site www.artely.com.br.

¡Congratulaciones, montaste tu mueble! ¡Ahora solo decora tu casa y disfruta!

Queremos ver este producto en tu hogar, a tu manera... Utilice #meuartely, ¡ficaremos encantados de compartir tu foto!

Si tienes alguna duda, sugerencia o comentario, contáctenos a través de nuestro sitio web www.artely.com.br.

Congratulations, you've assembled your new furniture! Decorate your home and enjoy!

We want to see how this product is in your home... Use #meuartely, we will be happy to share your picture!

If you have any doubt, suggestion or comment, get in touch with us through our website www.artely.com.br.

