

# KAIKI

MÓVEIS

**KAIKI MÓVEIS INDÚSTRIA E COMÉRCIO LTDA.**

Av. Raul Alves Ferreira, 311 - Centro - Fone/Fax (32) 3577-1198  
 CEP 36510-000 - Rodeiro - MG  
 vendas@kaikimoveis.com.br



## Armário Aéreo LORENA Ref.: 2567

### COMPONENTES

- 1 - BASE
- 2 - LATERAL DIREITA
- 3 - LATERAL ESQUERDA
- 4 - PRATELEIRA
- 5 - TAMPO
- 6 - COSTAS
- 7 - PERFIL H
- 8 - PORTA

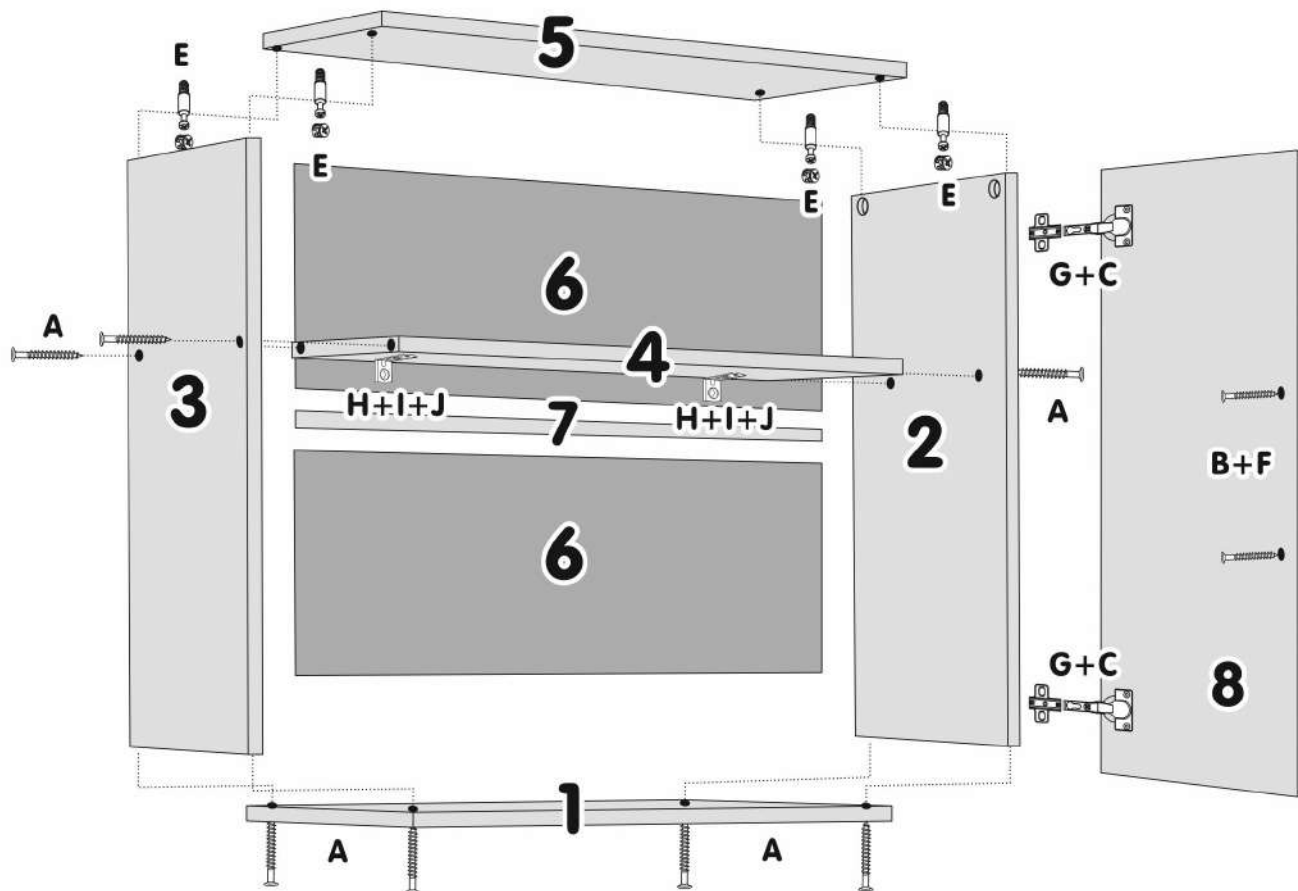

**ATENÇÃO: AS COSTAS SÃO FIXADAS COM PREGOS 10x10(D).**

**SR. MONTADOR, CASO HAJA ASSISTÊNCIA, ANOTAR NÚMERO DA PEÇA, NOME E COR, PASSE PARA A PESSOA RESPONSÁVEL, PARA QUE POSSAMOS ATENDÊ-LO O MAIS RÁPIDO POSSÍVEL.**

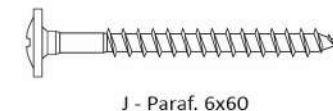

# KAIKI

MÓVEIS

**KAIKI MÓVEIS INDÚSTRIA E COMÉRCIO LTDA.**

Av. Raul Alves Ferreira, 311 - Centro - Fone/Fax (32) 3577-1198  
 CEP 36510-000 - Rodeiro - MG  
 vendas@kaikimoveis.com.br



## Balcão LORENA 5 PTS Ref.: 2570

Sr. Montador, caso haja assistência, anotar número da peça, nome e cor, passe para a pessoa responsável, para que possamos atendê-lo o mais rápido possível.

### COMPONENTES

1 - BASE	9 - COSTAS
2 - PÉ	10 - PERFIL H
3 - LATERAL ESQUERDA	11 - FRENTE GAVETA
4 - DIVISÃO PRAT.	12 - LATERAL GAVETA
5 - PRATELEIRA	13 - TRASEIRO GAVETA
6 - LATERAL DIREITA	14 - FUNDO GAVETA
7 - TAMPO	15 - PORTA BASCULA
8 - PORTA	

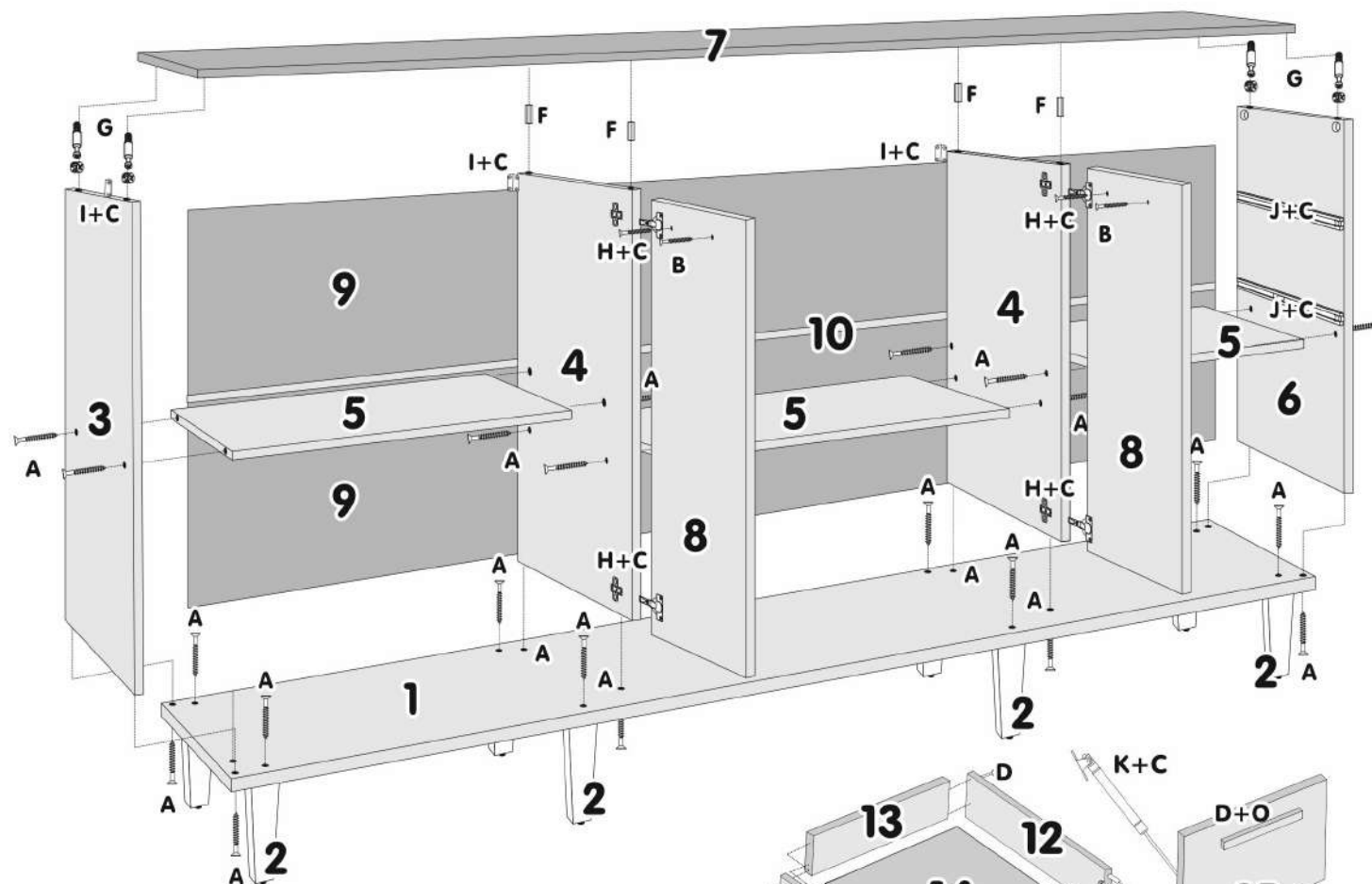

**ATENÇÃO: AS COSTAS E FUNDO DA GAVETA  
SÃO FIXADOS COM PREGOS 10x10.**



A - Paraf. 4,5x50



B - Paraf. 4x25



C - Paraf. 3,5x14



D - Prego 13x15



E - Prego 10x10



F - Cavilha 6x30



G - Minifix

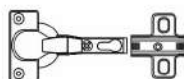

H - Dobradiça de Pressão



I - Cantoneira 4 Furos



J - Corrediça Telescópica



K - Pistão

# KAIKI

MÓVEIS

**KAIKI MÓVEIS INDÚSTRIA E COMÉRCIO LTDA.**

Av. Raul Alves Ferreira, 311 - Centro - Fone/Fax (32) 3577-1198  
 CEP 36510-000 - Rodeiro - MG  
 vendas@kaikimoveis.com.br



## Armário Aéreo LORENA Ref.: 2567

### COMPONENTES

- 1 - BASE
- 2 - LATERAL DIREITA
- 3 - LATERAL ESQUERDA
- 4 - PRATELEIRA
- 5 - TAMPO
- 6 - COSTAS
- 7 - PERFIL H
- 8 - PORTA

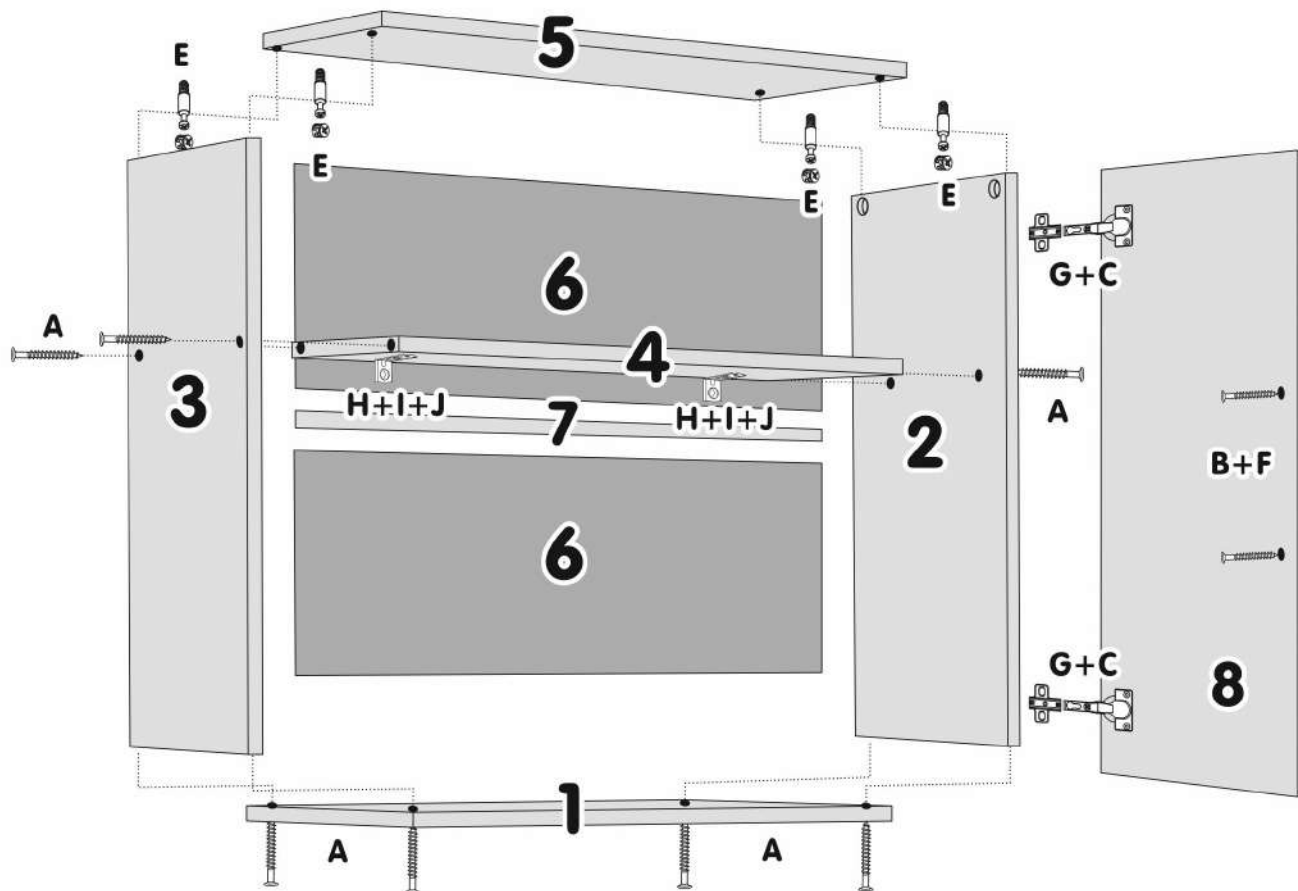

**ATENÇÃO: AS COSTAS SÃO FIXADAS COM PREGOS 10x10(D).**

**SR. MONTADOR, CASO HAJA ASSISTÊNCIA, ANOTAR NÚMERO DA PEÇA, NOME E COR, PASSE PARA A PESSOA RESPONSÁVEL, PARA QUE POSSAMOS ATENDÊ-LO O MAIS RÁPIDO POSSÍVEL.**

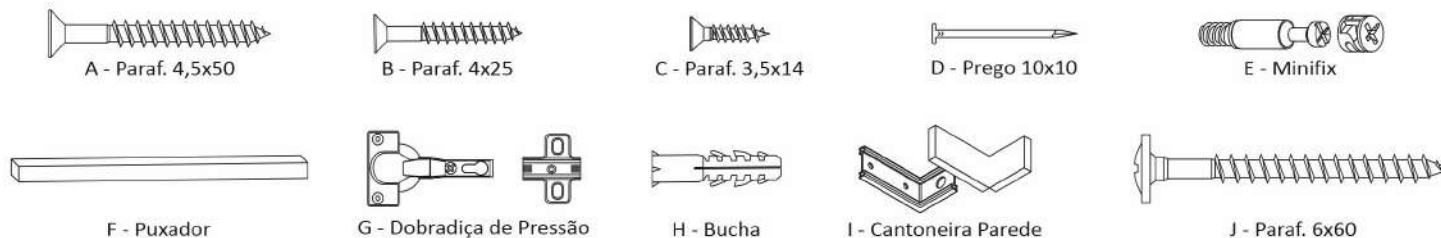



**KAIKI MÓVEIS INDÚSTRIA E COMÉRCIO LTDA.**

Av. Raul Alves Ferreira, 311 - Centro - Fone/Fax (32) 3577-1198  
 CEP 36510-000 - Rodeiro - MG  
 vendas@kaikimoveis.com.br



## Balcão LORENA 2 PTS Ref.: 2568

Sr. Montador, caso haja assistência, anotar número da peça, nome e cor, passe para a pessoa responsável, para que possamos atendê-lo o mais rápido possível.

### COMPONENTES

- |                      |              |
|----------------------|--------------|
| 1 - BASE             | 6 - TAMPO    |
| 2 - PÉ               | 7 - PORTA    |
| 3 - LATERAL ESQUERDA | 8 - COSTAS   |
| 4 - LATERAL DIREITA  | 9 - PERFIL H |
| 5 - PRATELEIRA       |              |

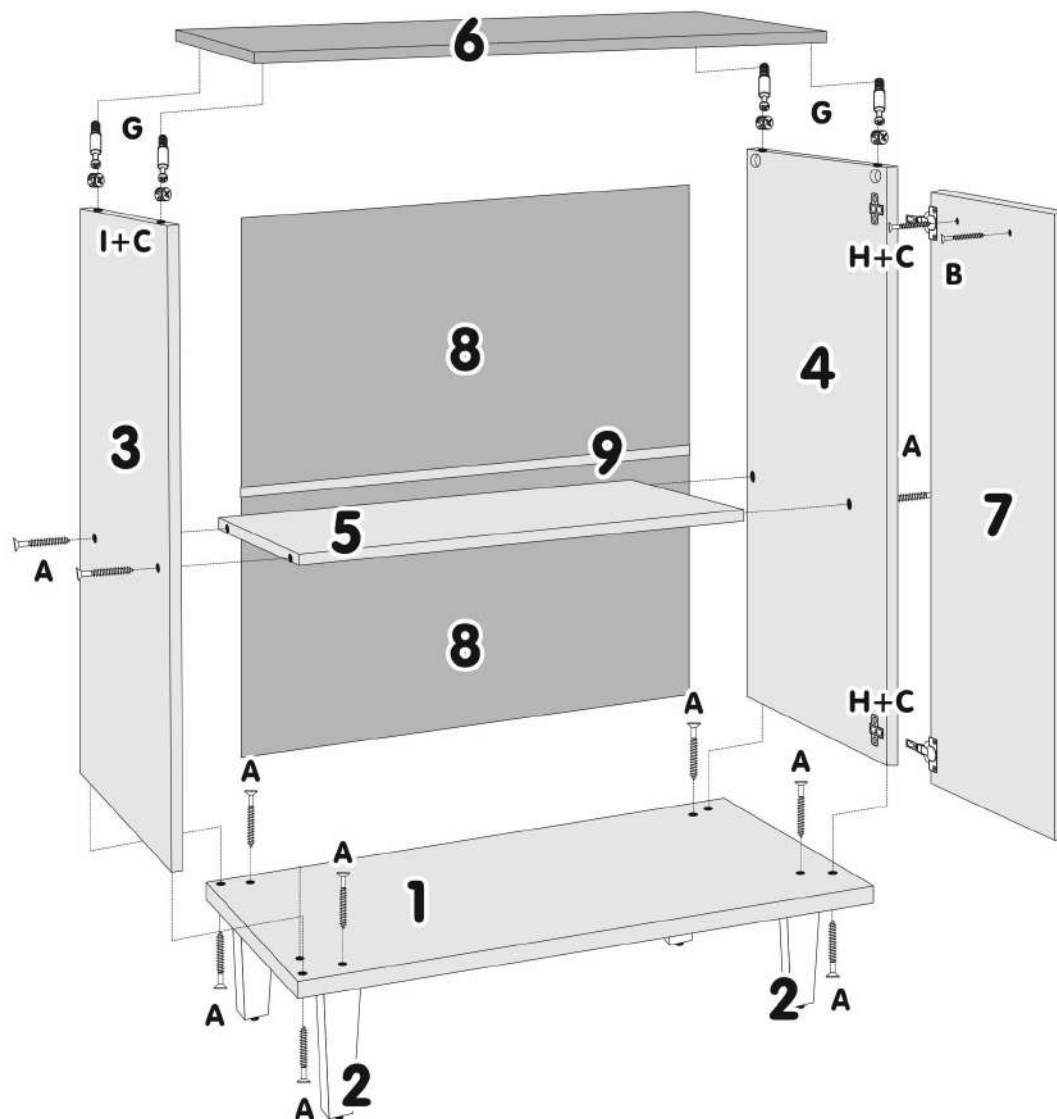

**ATENÇÃO: AS COSTAS E FUNDO DA GAVETA SÃO FIXADOS COM PREGOS 10x10.**

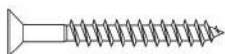

A - Paraf. 4,5x50



B - Paraf. 4x25



C - Paraf. 3,5x14



E - Prego 10x10

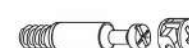

G - Minifix

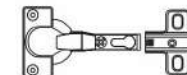

H - Dobradiça de Pressão



**KAIKI MÓVEIS INDÚSTRIA E COMÉRCIO LTDA.**

Av. Raul Alves Ferreira, 311 - Centro - Fone/Fax (32) 3577-1198  
CEP 36510-000 - Rodeiro - MG  
vendas@kaikimoveis.com.br



## Nicho Torre Quente LORENA Ref.: 2610

### COMPONENTES

- 1 - BASE
- 2 - LATERAL DIREITA
- 3 - LATERAL ESQUERDA
- 4 - PRATELEIRA
- 5 - TAMPO
- 6 - COSTAS
- 7 - PERFIL H

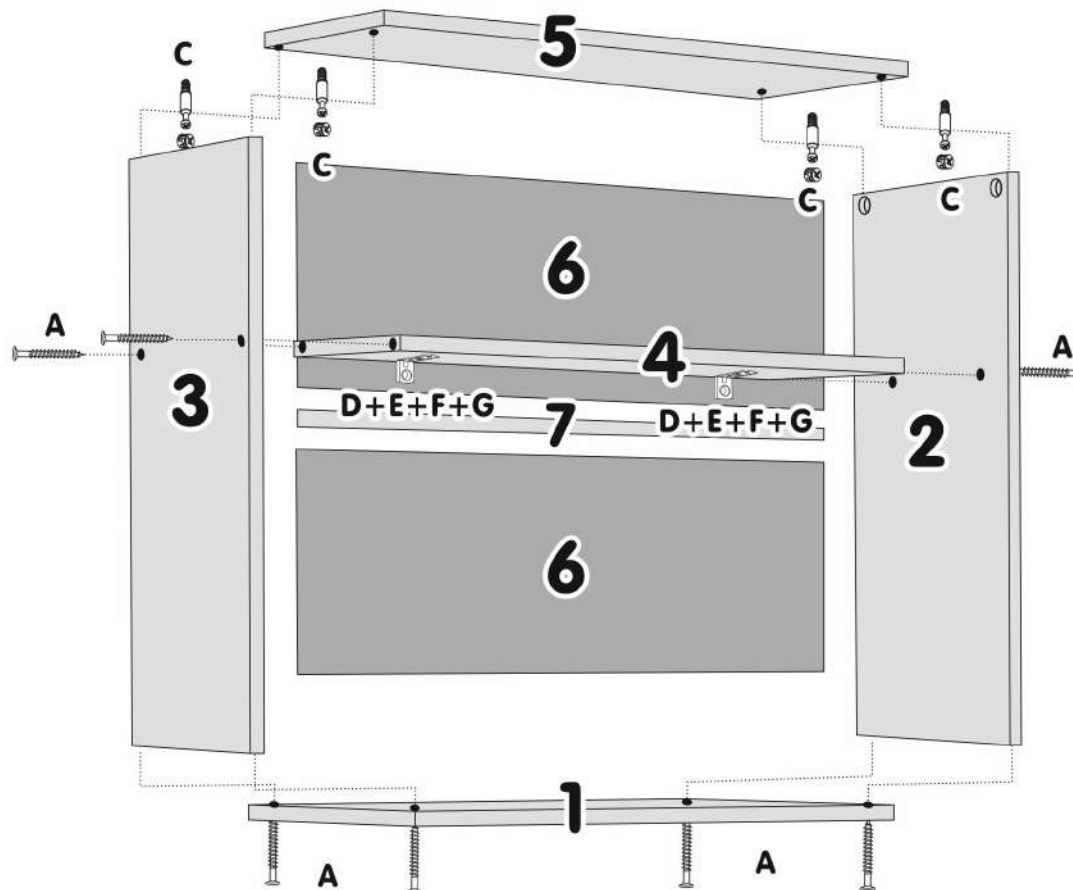

**ATENÇÃO: AS COSTAS SÃO FIXADAS COM PREGOS 10x10(B).**

**SR. MONTADOR, CASO HAJA ASSISTÊNCIA, ANOTAR NÚMERO DA PEÇA, NOME E COR, PASSE PARA A PESSOA RESPONSÁVEL, PARA QUE POSSAMOS ATENDÊ-LO O MAIS RÁPIDO POSSÍVEL.**



A - Paraf. 4,5x50



B - Prego 10x10

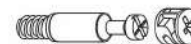

C - Minifix



D - Bucha

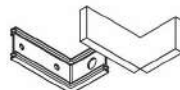

E - Cantoneira Parede

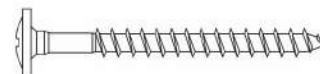

F - Paraf. 6x60



G - Paraf. 3,5x14