



Ferramentas Necessárias (Não Fornecidas)

LIMPEZA E CONSERVAÇÃO
A limpeza do móvel deve ser efetuada **somente com pano macio e seco.**
Não utilizar produtos abrasivos ou similares, tais como:
• Cera;
• Detergentes;
• Álcool;
• Lustra-móveis;
• Tinner;
• etc.

IMPORTANTE
ASSISTÊNCIA TÉCNICA - EM CASO DE SOLICITAÇÕES DE PEÇAS EM ASSISTÊNCIA TÉCNICA E NECESSÁRIO QUE AS MESMAS SEJAM SOLICITADAS JUNTO A LOJA OU SITE NO QUAL A COMPRA DO PRODUTO FOI REALIZADA.

Carga Suportável
O peso máximo de carga informado no desenho ao lado refere-se a objetos distribuídos de maneira uniforme sobre toda área de contato de peça.

ATENÇÃO:
1. Ler atentamente toda a instrução antes de iniciar a montagem do móvel.
2. A montagem deverá ser feita em superfície limpa e plana, aconselhamos forrar o chão com a embalagem do produto a fim de não danificá-lo.
3. Os parafusos devem ser apertados periodicamente.
4. Evitar batidas e contato com objetos cortantes.
5. Observar as cargas máximas suportadas de acordo com o desenho.

NÃO ESTÃO COBERTOS PELA GARANTIA PROBLEMAS QUE TENHAM ORIGEM NA UTILIZAÇÃO DO PRODUTO DE FORMA INADEQUADA OU NA EXPOSIÇÃO DO MESMO A INTEMPÉRIES COMO: INFILTRAÇÕES DE ÁGUA, INFESTAÇÃO DE CUPINS E PRAGAS EM GERAL APARECIMENTO DE MOFO E OUTROS DECORRENTES DO AMBIENTE DE INSTALAÇÃO.

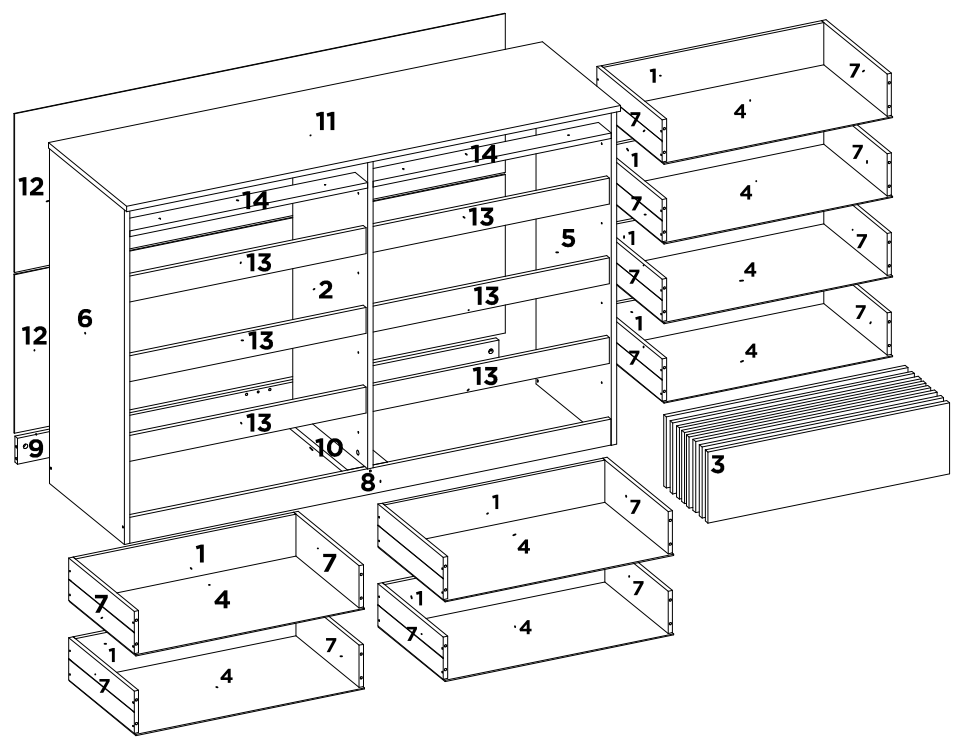





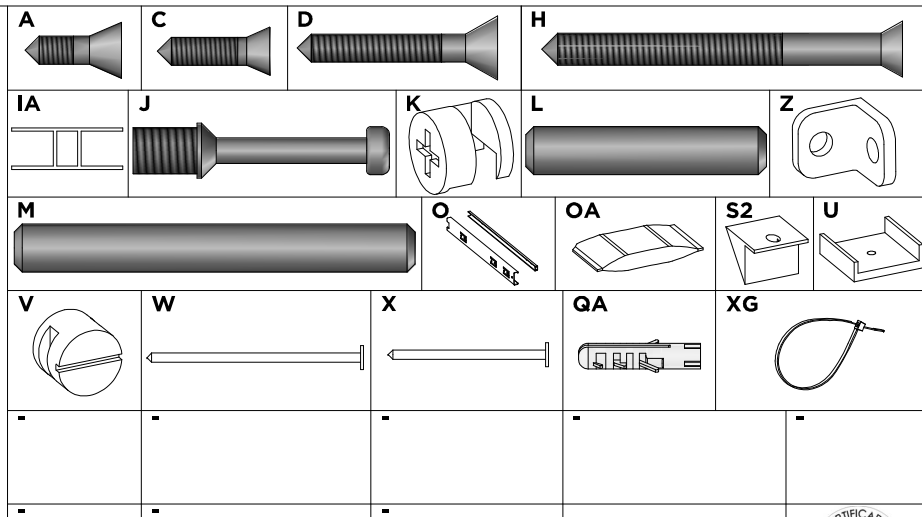





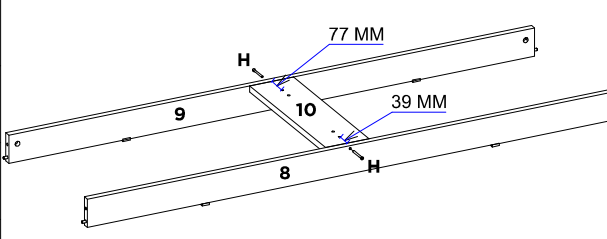

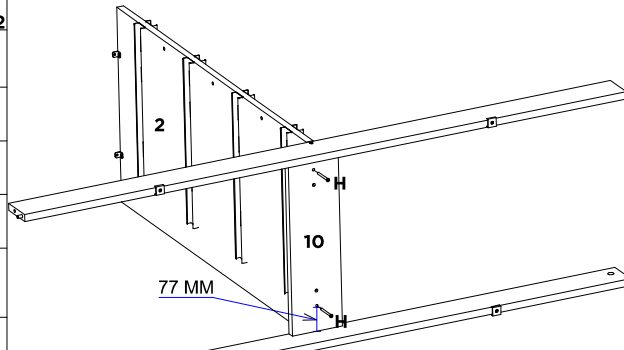

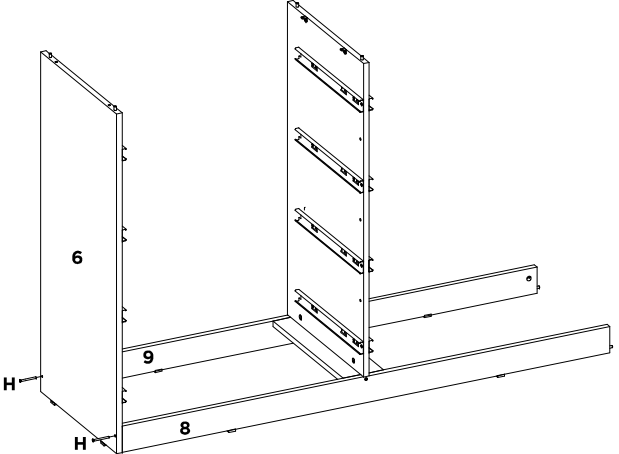

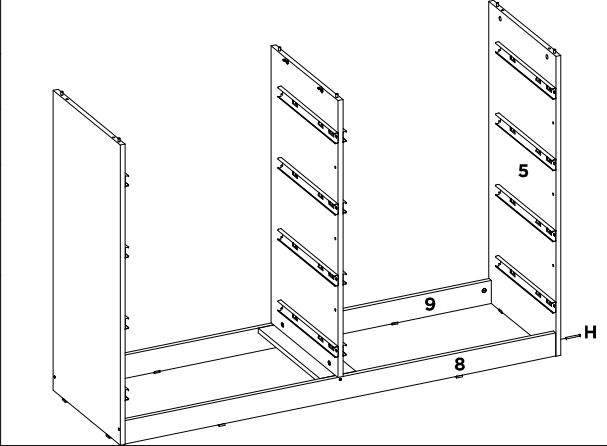

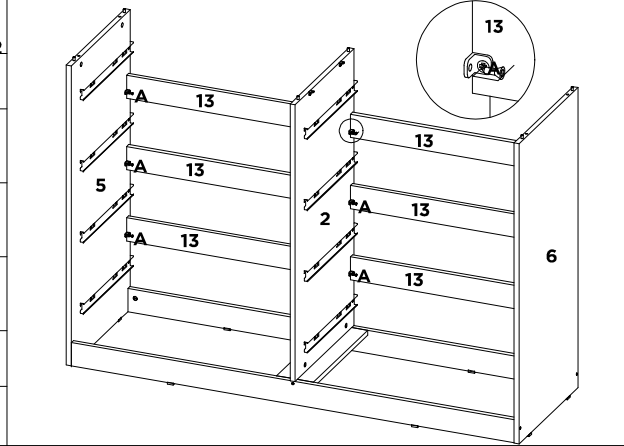

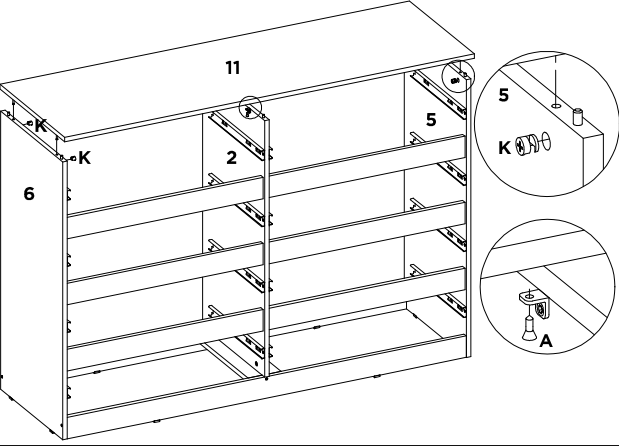

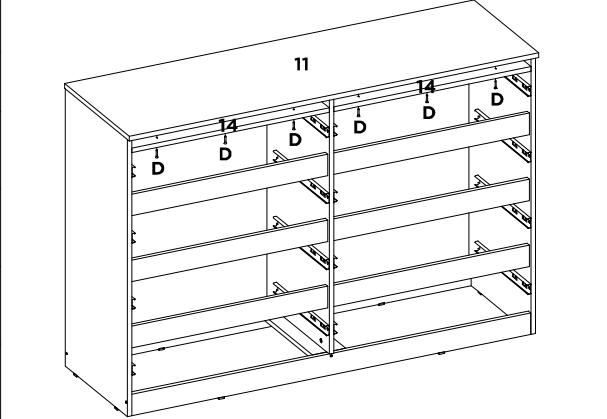



SEQ.	CODIGO	CARGA SUPORTÁVEL					DESCRICAO	COMP.	LARG.	ESP.	QTD.	MATERIAL
		BRANCO BRILHO REF_01	CRAVO FOSCO REF_02	NOCE FOSCO REF_03	AMENDOLA REF_04	REF_05						
1	06056	03	112	113	138	-	CONTRA FUNDO	607	114	12	8	MDP
2	08415	03	112	113	138	-	DIVISAO DIREITA	835	413	15	1	MDP
3	09231	03	105	106	134	-	FRENTE DE GAVETA	665	192	15	8	MDP
4	10157	03	112	113	138	-	FUNDO GAVETA	629	368	3	8	HDF
5	11530	03	105	106	134	-	LATERAL DIREITA	905	413	15	1	MDP
6	11531	03	105	106	134	-	LATERAL ESQUERDA	905	413	15	1	MDP
7	12058	03	112	113	138	-	LATERAL DE GAVETA	360	114	12	16	MDP
8	16455	03	105	106	134	-	RODAPE FRONTAL	1325	70	15	1	MDP
9	16456	20	20	20	20	-	RODAPE TRASEIRO	1325	70	15	1	MDP
10	18034	20	20	20	20	-	SUPORE DA BASE	381	110	15	1	MDP
11	19306	03	105	106	134	-	TAMPO	1360	430	15	1	MDP
12	20535	20	20	20	20	-	TRASEIRO	1351	428	3	2	HDF
13	29141	03	105	106	134	-	VISTA DA GAVETA	655	70	15	6	MDP
14	29142	03	112	113	138	-	VISTA DO TAMPO	655	70	15	2	MDP

ACESSÓRIOS

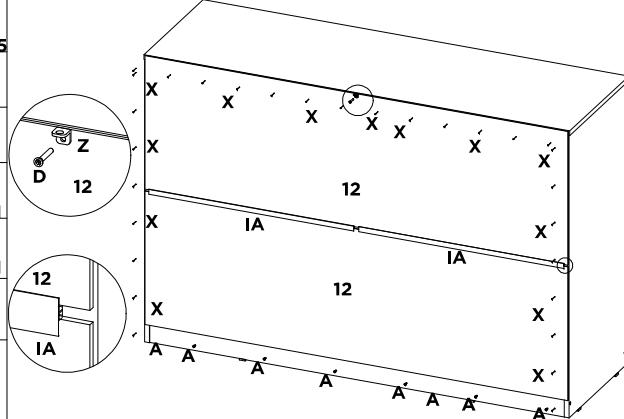



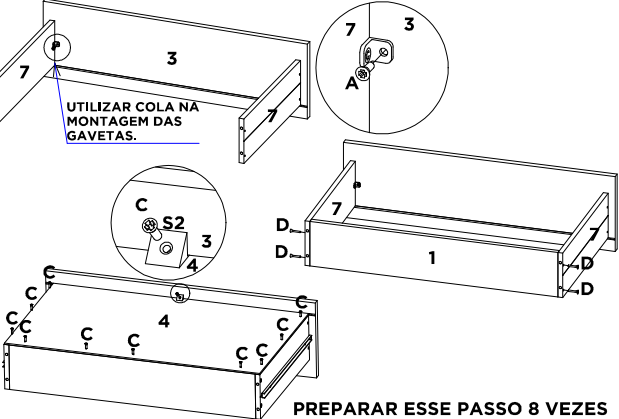

SEQ.	CODIGO	CARGA SUPORTÁVEL					DESCRICAO	QTD.	MATERIAL
		BRANCO BRILHO REF_01	CRAVO FOSCO REF_02	NOCE FOSCO REF_03	AMENDOLA REF_04	REF_05			
A	9905002	-	-	-	-	-	PARAFUSO 3.5 X 12 MM CHATA PHILIPS	148	ACO
C	9905046	-	-	-	-	-	PARAFUSO 3.5 X 14 MM CHATA PHILIPS	88	ACO
D	9905018	-	-	-	-	-	PARAFUSO 3.5 X 25 MM CHATA PHILIPS	39	ACO
H	9905045	-	-	-	-	-	PARAFUSO 4 X 45 MM CHATA PHILIPS	9	ACO
IA	9928036	138	138	138	138	-	PERFIL H 655 X 16 X 6 MM PLASTICO	2	PLASTICO
J	9920029	-	-	-	-	-	PINO MINIFIX 12 MM	4	ACO
K	9920009	-	-	-	-	-	CASTANHA MINIFIX 12 MM	4	ACO
L	9920011	-	-	-	-	-	CAVILHAS 6 X 30 MM	54	MADEIRA
M	9920012	-	-	-	-	-	CAVILHAS 6 X 50 MM	3	MADEIRA
O	9913004	-	-	-	-	-	CORREDICA TELESCOPICA LARG 32 MM DE 350 MM METAL	8	ACO
OA	9912006	-	-	-	-	-	SACHET DE COLA 10 GRAMAS	4	PLASTICO
QA	9920056	-	-	-	-	-	BUCHA PLASTICA 8MM CINZA	1	PLASTICO
S2	9920058	-	-	-	-	-	SUPORE TRIANGULAR 14 X 14	8	PLASTICO
U	9924002	03	13	13	13	-	MINI SAPATA 15 MM	8	PLASTICO
V	9920030	-	-	-	-	-	PORCA CILINDRICA 9 X 12 MM	6	PLASTICO
W	9906001	-	-	-	-	-	PREGO 12X12 MM	8	ACO
X	9906002	-	-	-	-	-	PREGO 9X9 MM	45	ACO
XG	9920094	-	-	-	-	-	ABRACADEIRA DE NYLON TARAP 30 CM	1	PLASTICO
Z	9920007	-	-	-	-	-	CANTONEIRA ZAMAC 12 MM	32	ACO



10	FIXAR RODAPÉS NO SUPORTE DA BASE.	11	FIXAR LATERAL ESQUERDA NOS RODAPÉS. 8230
 		 	 
 	13 FIXAR LATERAL DIREITA NOS RODAPÉS.	 	15 FIXAR TAMPO NAS LATERAIS E DIVISÃO. FIXAR O TAMPO COM AS CANTONEIRAS NA DIVISÃO.   
 	16 FIXAR VISTAS DO TAMPO NO TAMPO.	       	18 MONTAR 08 GAVETAS.        <p style="text-align: right;">PREPARAR ESSE PASSO 8 VEZES</p>

19 **FIXAR O MOVEL NA PAREDE E ENCAIXAR AS GAVETAS**

QA  X1
XG  X1
H  X1
Z  X1

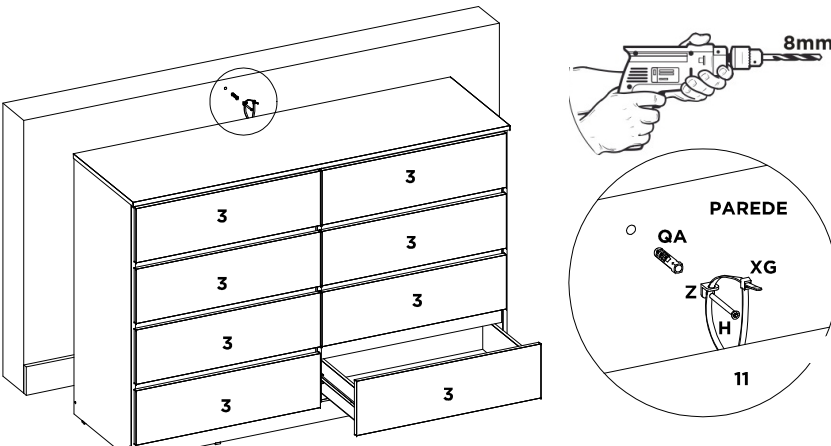

8mm

PAREDE

QA **XG**
Z **H**

11

20 **PESO MÁXIMO DISTRIBUIDO.**

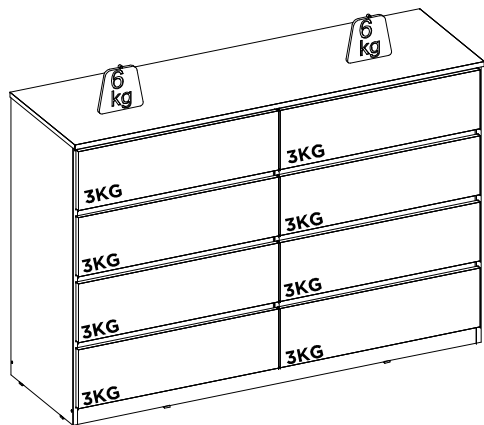

21 **ASPECTO FINAL DO PRODUTO.**

