

Bancada Gourmet Requite | Mostrador Gourmet Requite | Requite Gourmet Counter

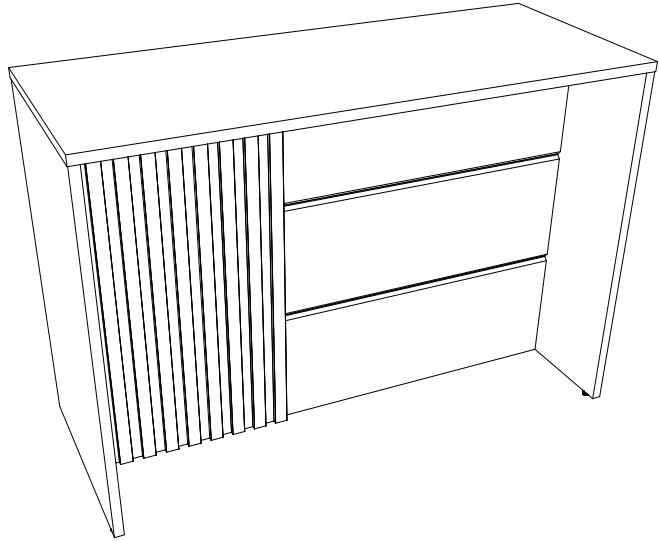

Requisitos para montagem Requisitos para la montaje Assembly Requirements

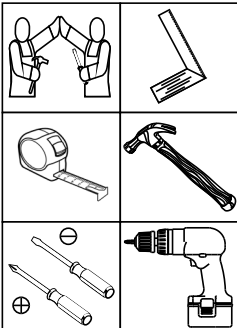

Imagens meramente ilustrativas,
não acompanha o produto.
Imágenes ilustrativas, no incluidas
con el producto.
Illustrative images, not included
with the product.

AVISO

Para limpeza de seu móvel, use uma flanela seca ou umedecida, e não utilize produtos químicos que possam danificar seu produto.

SISTEMA DE MONTAGEM

O sistema de montagem dos produtos, funciona de acordo com a ordem crescente dos números indicados no desenho. Ex: 01, 02, 03, 04... até a conclusão da montagem.

ASSISTÊNCIA TÉCNICA

Para solicitação de Assistência Técnica você consumidor deverá entrar em contato com o Lojista o qual você realizou a compra deste produto e solicitar a assistência técnica das peças avariadas. A garantia abrange todas as peças, partes e componentes que eventualmente venham apresentar defeito de fabricação no prazo de 03 (três) meses, contando a partir da entrega do produto ao consumidor, mediante nota fiscal de compra. Se houver qualquer alteração na estrutura do produto ou ocorrer defeito por negligência do montador/consumidor em relação a instrução de montagem e manuseio, não será fornecido assistência técnica gratuita.

ADVERTENCIA

Para limpieza de su móvil, use una franela seca o húmeda, y no utilice productos químicos que puedan dañar su producto.

SISTEMA DE MONTAJE

El sistema de montaje de los productos funciona de acuerdo con el orden creciente de los números indicados en el dibujo. Ej.: 01, 02, 03, 04... hasta la conclusión del montaje.

ASISTENCIA TÉCNICA

Para solicitar Asistencia Técnica, el consumidor debe comunicarse con el Comercio que usted realizó la compra de este producto y solicita asistencia técnica para las partes dañadas. La garantía cubre todas las partes, piezas y componentes que eventualmente puedan presentar defecto de fabricación en el plazo de 03 (tres) meses, contados a partir de la entrega del producto al consumidor, mediante factura de compra. Si se produce algún cambio en la estructura del producto o se produce un defecto por negligencia del montador/consumidor en relación con las instrucciones de montaje y manipulación, no se prestará asistencia técnica gratuita.

NOTICE

To clean your furniture, use a dry or wet cloth, and do not use chemicals that may damage your product.

ASSEMBLY SYSTEM

The products' assembly system works according to the increasing order of the indicated numbers. For example: 01, 02, 03, 04 ... to the end of the assembly.

TECHNICAL ASSISTANCE

To request Technical Assistance, the consumer must contact the retailer from whom you purchased this product and request technical assistance for the damaged parts. The warranty covers all parts, parts and components that may eventually present a manufacturing defect within a period of 03 (three) months, counting from the delivery of the product to the consumer, by means of a purchase invoice. If there is any change in the structure of the product or defect occurs due to negligence of the assembler/consumer in relation to the assembly and handling instruction, free technical assistance will not be provided.

ACESSÓRIOS | ACCESORIOS | ACCESSORIES

A 



x42

B

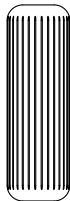

x24

C

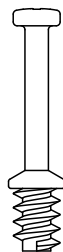

x19

D

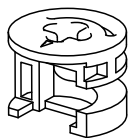

x19

E

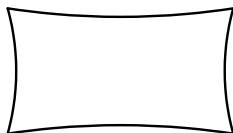

x1

F

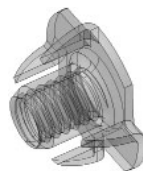

x4

G



x4

H

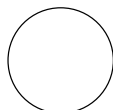

x6

I



x1

J



x1

LISTA DE PEÇAS | LISTA DE PIEZAS | LIST OF PIECES

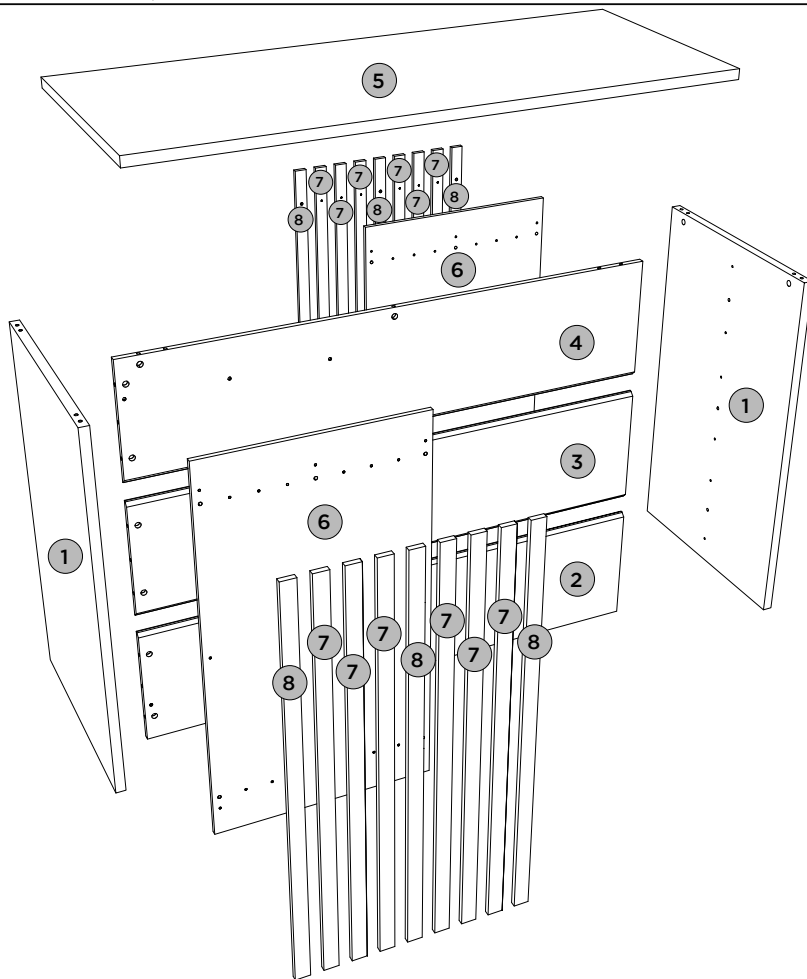





Item	Caixa Caja Box	Qtd Ctd Qty	Descrição Descripción Description	Dimensões (mm) Dimensiones (mm)		
				Comprimento Largo Length	Largura Ancho Width	Espessura Grosor Thickness
1	1/1	02	LATERAL DIREITA ESQUERDA LADO IZQUIERDO DERECHO LEFT RIGHT SIDE	975	600	25
2	1/1	01	PAINEL INFERIOR PANEL INFERIOR BOTTOM PANEL	1402	325	15
3	1/1	01	PAINEL CENTRAL PANEL CENTRAL CENTER PANEL	1402	325	15
4	1/1	01	PAINEL SUPERIOR PANEL SUPERIOR TOP PANEL	1402	325	15
5	1/1	01	TAMPO TAPA TOP	1456	603	25
6	1/1	02	PAINEL COM APLIQUE PANEL CON APLICACIÓN PANEL WITH APPLICATION	975	547	12
7	1/1	12	APLIQUE APLICAR APPLY	974	35	12
8	1/1	06	APLIQUE FURO MAIOR APLICAR AGUJERO MÁS GRANDE APPLY BIGGER HOLE	974	35	12

PASSO 1

PEÇAS REQUERIDAS

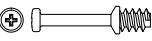
1	LATERAL DIREITA ESQUERDA	x2
5	TAMPO	x1

ACESSÓRIOS REQUERIDOS

B		04
C		19
E		
F		04
G		04

FERRAMENTAS NECESSÁRIAS

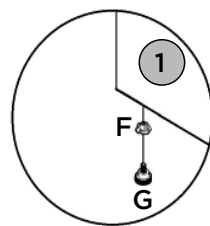
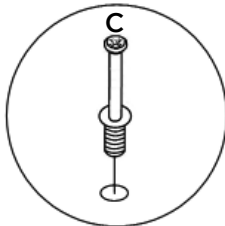
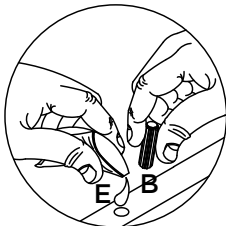
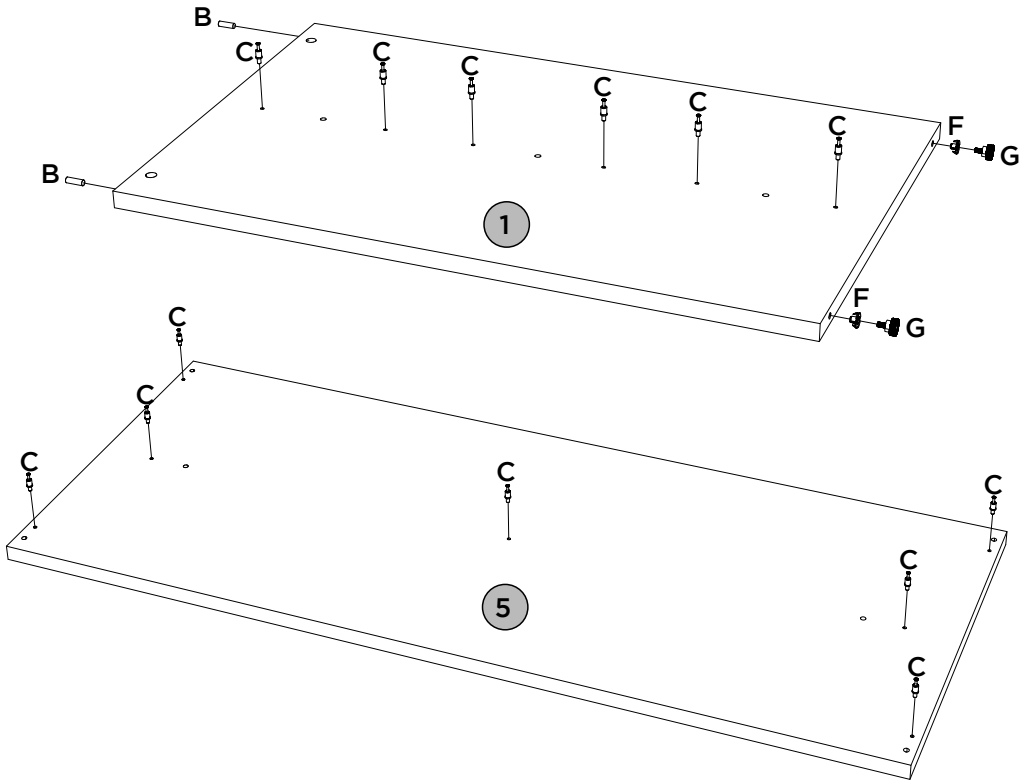
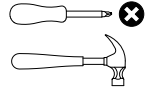



PASSO 2

ITM/C630-

PEÇAS REQUERIDAS

2	PAINEL INFERIOR	x1
3	PAINEL CENTRAL	x1
4	PAINEL SUPERIOR	x1
8	APLIQUE FURO MAIOR	x6

ACESSÓRIOS REQUERIDOS

B		20
E		

FERRAMENTAS NECESSÁRIAS

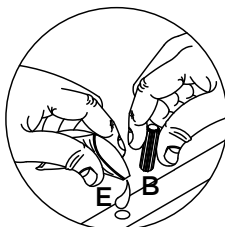
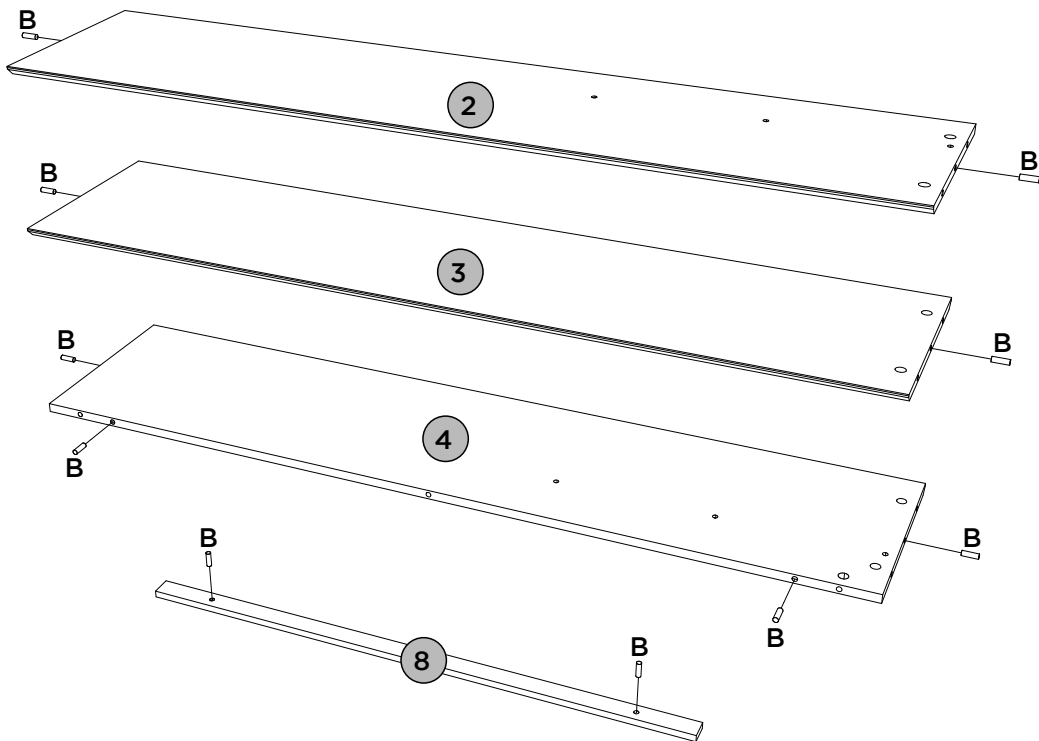
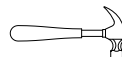

PASSO 3

ITM/C630-

PEÇAS REQUERIDAS

1	LATERAL DIREITA ESQUERDA	x2
2	PAINEL INFERIOR	x1
3	PAINEL CENTRAL	x1
4	PAINEL SUPERIOR	x1

ACESSÓRIOS REQUERIDOS

D		12
---	--	----

FERRAMENTAS NECESSÁRIAS

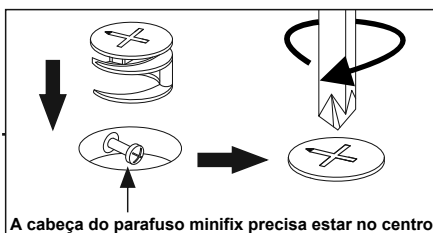
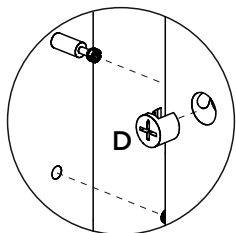
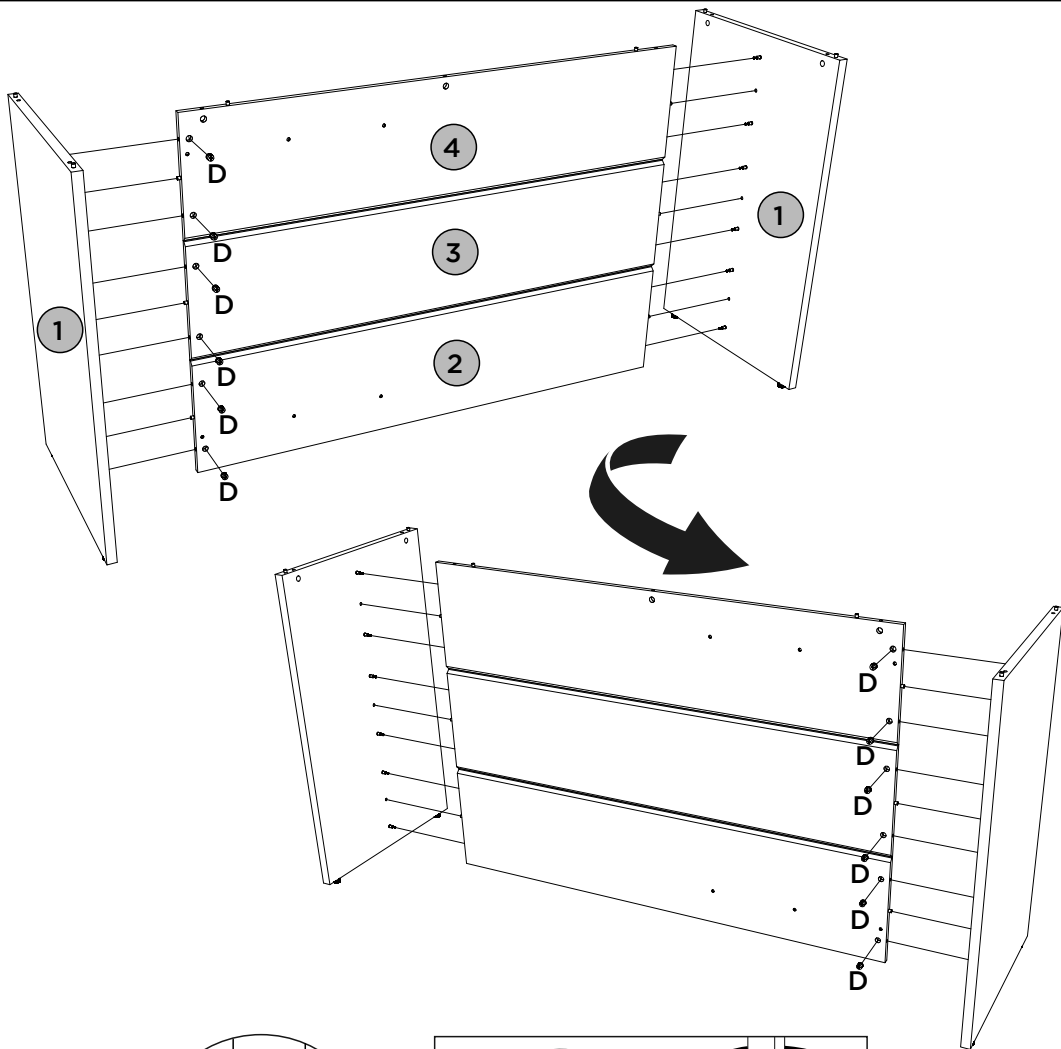
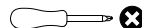

PEÇAS REQUERIDAS

ACESSÓRIOS REQUERIDOS

FERRAMENTAS NECESSÁRIAS

5	TAMPO	x1
---	-------	----

D		07
---	--	----

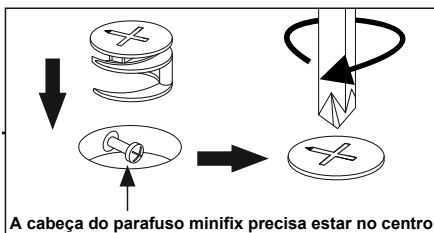
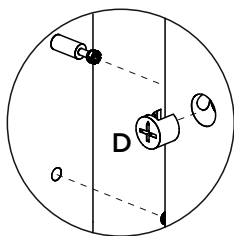
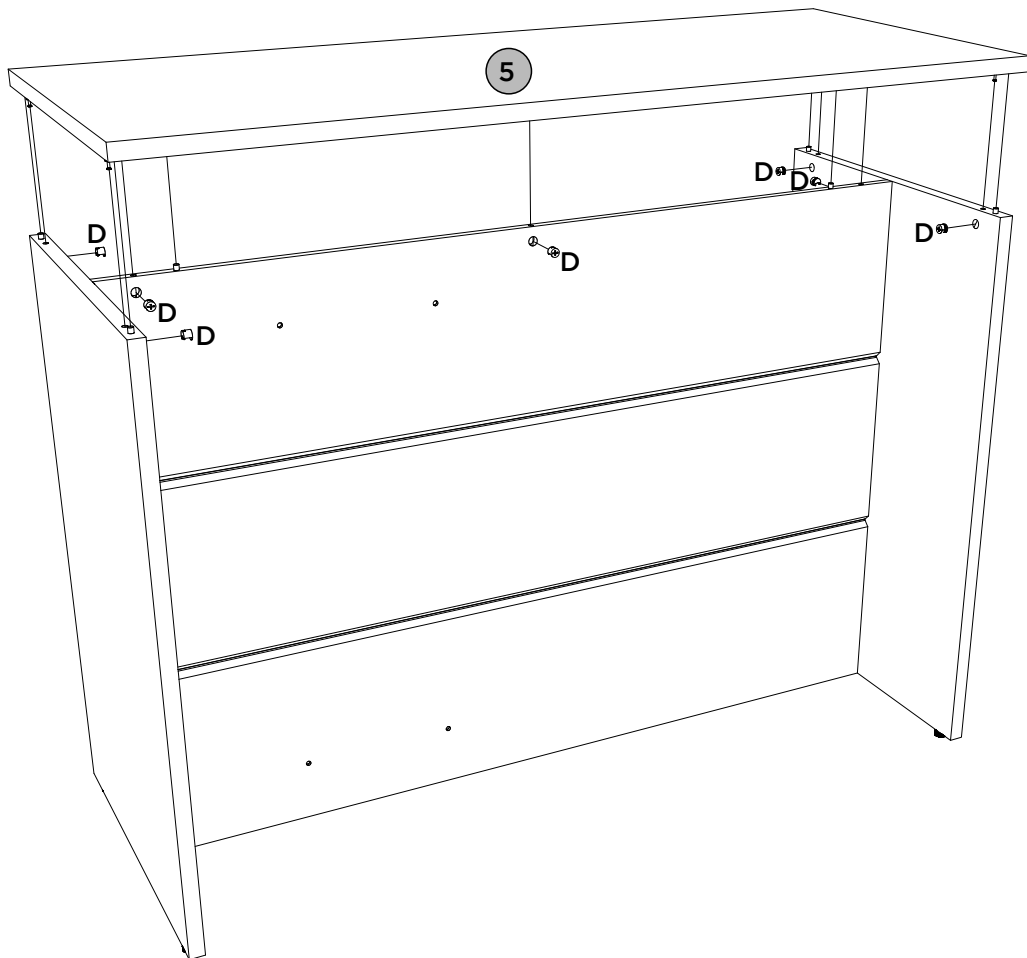
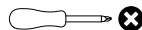

PASSO 5**PEÇAS REQUERIDAS**

6	PAINEL COM APLIQUE	x2
7	APLIQUE	x12

ACESSÓRIOS REQUERIDOS

A		24
---	---	----

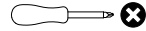
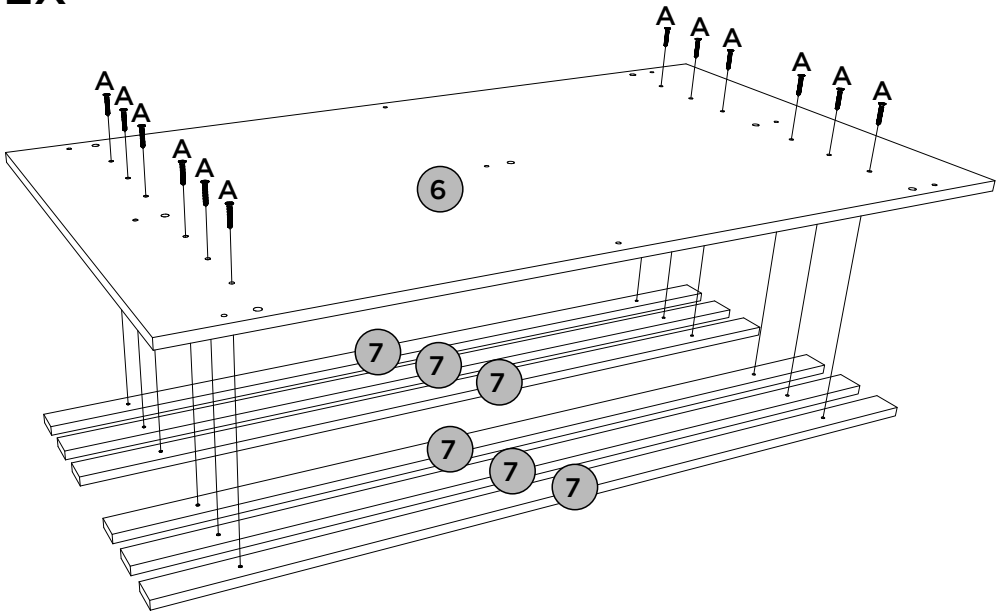
FERRAMENTAS NECESSÁRIAS**2X**

PEÇAS REQUERIDAS

ACESSÓRIOS REQUERIDOS

FERRAMENTAS NECESSÁRIAS

6	PAINEL COM APLIQUE	x2
---	--------------------	----

A			18
---	---	---	----

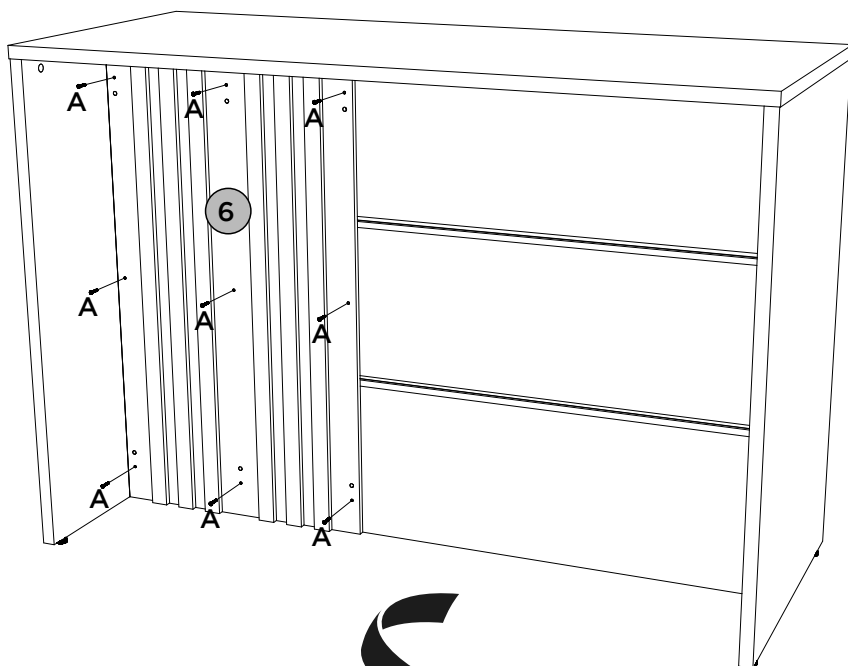
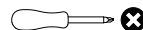

PEÇAS REQUERIDAS



8	APLIQUE FURO MAIOR	x6
---	--------------------	----

ACESSÓRIOS REQUERIDOS

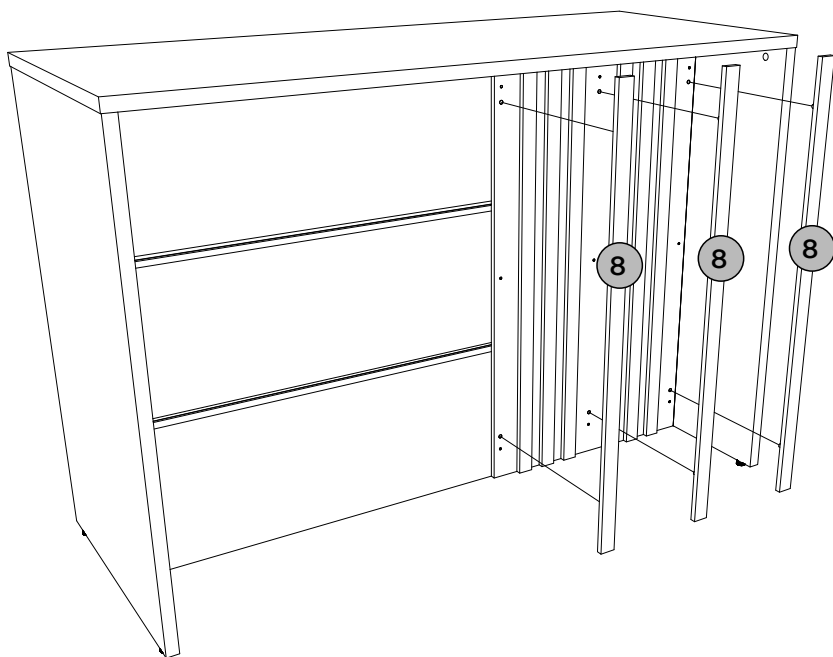
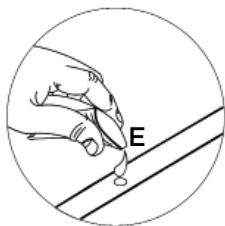
E		
---	--	--



ACESSÓRIOS REQUERIDOS

H		06
I		01
J		01

Pesos máximos recomendados com carga distribuída
 Peso máximo recomendado con la carga distribuida
 Recommended maximum weight with distributed load.

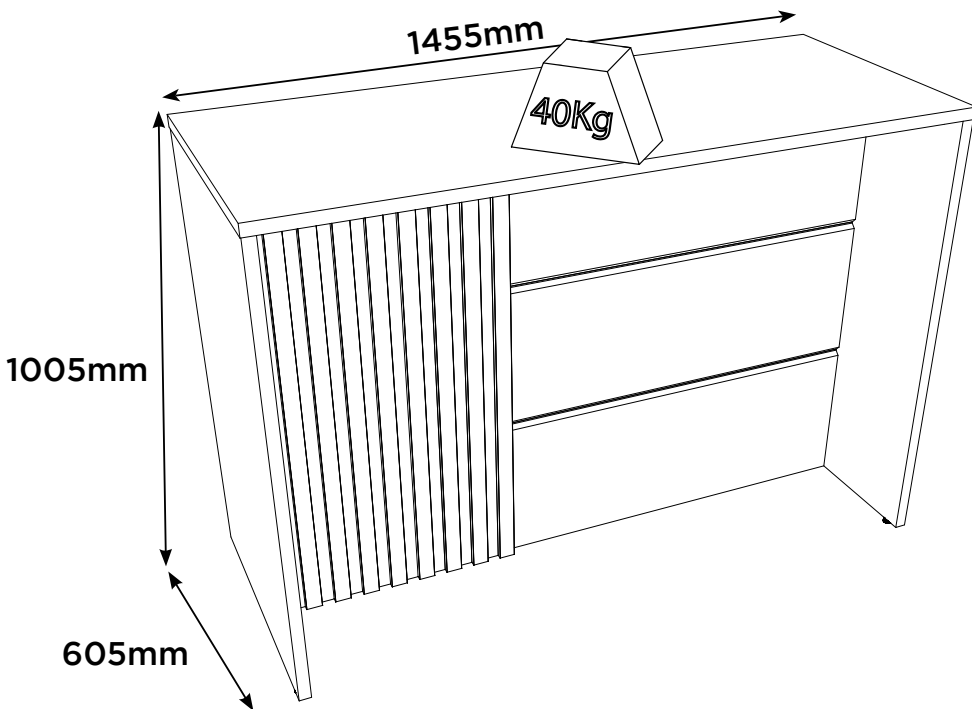

PERFECT CORRECTION
 CORRECCIÓN PERFECTA

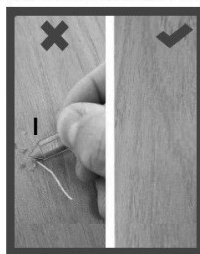
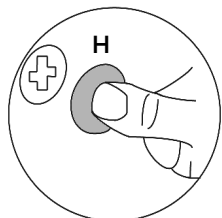

Produto Concluído
Producto terminado
Finished Product

