









**FERRAGENS**

A		Parafuso 4,5 x 50
B		Prego 10 x 10
C		Cavilhas 6 x 30
D		Pé
E		Cantoneira
G		Puxador
H		Parafuso 3,5 x 25
I		Dobradiça
J		Parafuso 3,5 x 14
K		Parafuso 4 x 40

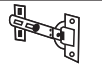

Consta marcação no tampo superior, para recortar para instalação de fogão apenas 4 Bocas

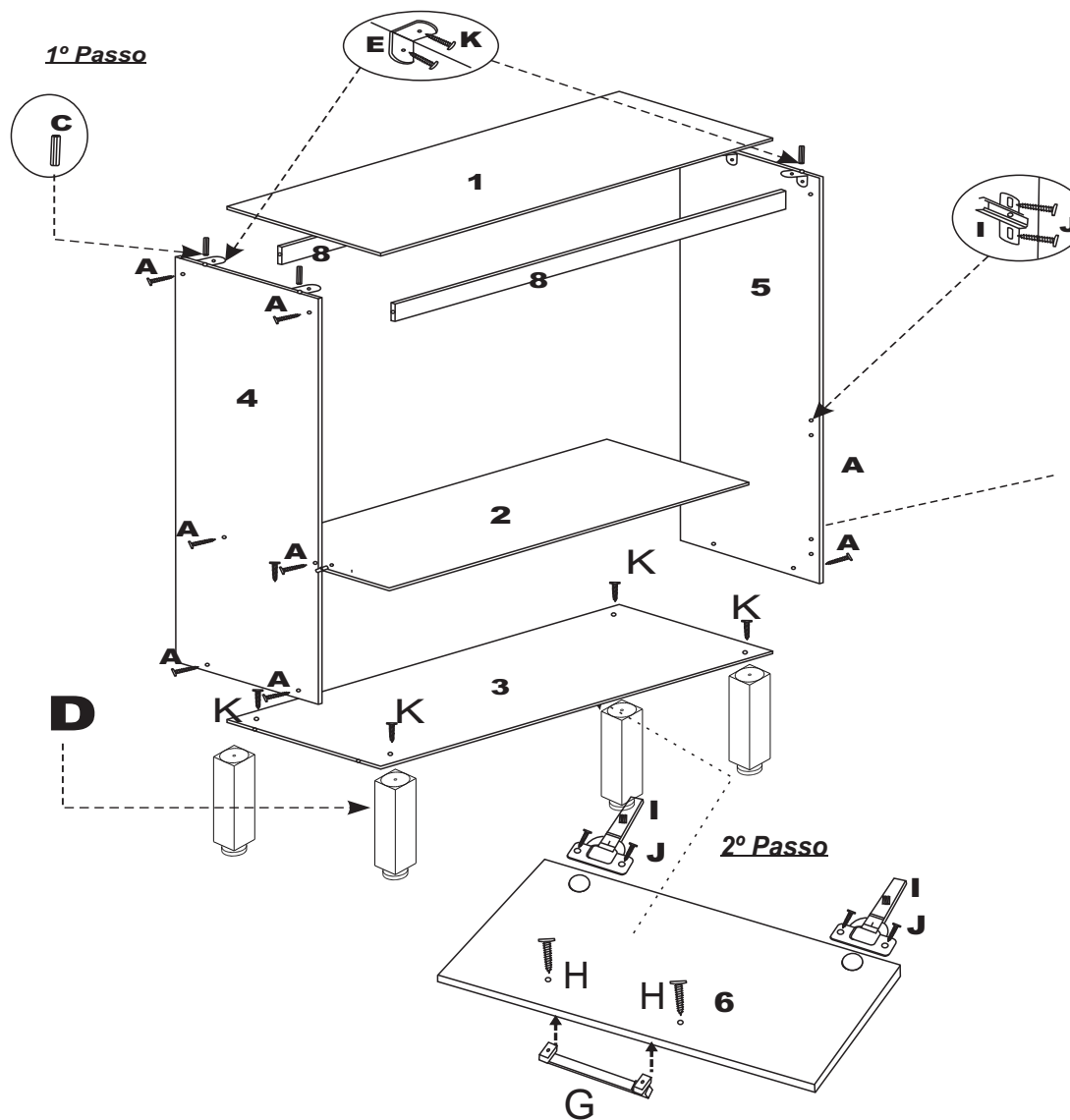