

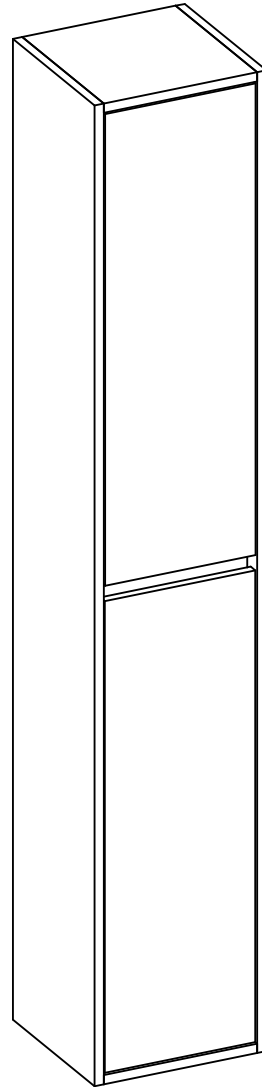



BA3030

Soluções Criativas para o seu lar

REVISÃO/ REVISIÓN/ REVISION: 00



BA3030	
	158,0 CM
	28,2 CM
	27,0 CM

RECOMENDAÇÕES:

01 - Examine completamente todas as peças do móvel antes de iniciar o trabalho.

02 - Recomenda-se montar o móvel conforme este Manual de Montagem.

03 - É de responsabilidade do montador seguir as instruções do Manual de Montagem, que são fundamentais para garantir a estrutura do móvel.

04 - Certifique-se de que todos os acessórios utilizados na montagem (parafusos, porcas, ponteiras) estejam fixados o suficiente, totalmente atarraxados, evitando que venham a provocar ferimentos.

LIMPEZA:

01 - Pano levemente umedecido com água, seguido de pano seco.

02 - Não utilizar produtos químicos ou abrasivos.

GARANTIA:

01 - 3 meses para defeitos ou vícios de origem.

ADVERTÊNCIAS:

01 - Esteja ciente do risco de chama aberta e outras fontes de calor, tais como aquecedores elétricos, aquecedores a gás etc. nas proximidades do produto.

02 - Não utilize o produto se alguma parte estiver quebrada, rasgada ou faltando. Utilizar somente peças de reposição aprovadas pelo fabricante.

RECOMENDACIONES:

01 - Examine completamente todas las piezas del mueble antes de empezar el montaje.

02 - Se recomienda montar el mueble de acuerdo con este Manual de Montaje.

03 - Es de responsabilidad del montador seguir las instrucciones del Manual de Montaje, que son fundamentales para asegurar la estructura del mueble.

04 - Asegure-se de que todos los accesorios utilizados en el montaje (tornillos, tuercas, ponteras) estén fijados el suficiente, totalmente roscados, evitando que vengam a provocar lesiones.

LIMPIEZA:

01 - Paño levemente humedecido con agua, siguiendo de paño seco.

02 - No utilizar productos químicos o abrasivos.

GARANTÍA:

01 - 3 meses para defectos o vicios de origen.

ADVERTENCIAS:

01 - Tenga en cuenta el riesgo de llama abierta y otras fuentes de calor, tales como calentadores eléctricos, calentadores de gas, etc cerca del producto.

02 - No utilice el producto si alguna parte esté rota, o perdida. Utilizar sólo piezas de repuesto aprobadas por el fabricante.

RECOMMENDATIONS:

01 - Check completely all the furniture's pieces before start to assemble it.

02 - It is recommended to assemble this furniture according to this Assembly's Manual.

03 - It is the assembler's responsibility to follow the instructions of this Assembly's Manual, which are essential to ensure the furniture's structure.

04 - Ensure that all bolts, nuts and tips are threaded thoroughly and fixed to the furniture, but do not overtighten it.

CLEANING:

01 - Wipe with cloth slightly moistened with water.

02 - Do not use chemicals or abrasive products.

WARRANTY:

01 - 3 months due to manufacture defects.

WARNINGS:

01 - Be aware of the risk of open flame and other sources of heat, such as electric heaters, gas heaters etc. around the product.



02 - Do not use the product if any part is broken, torn or missing. Only use replacement parts approved by the manufacturer.

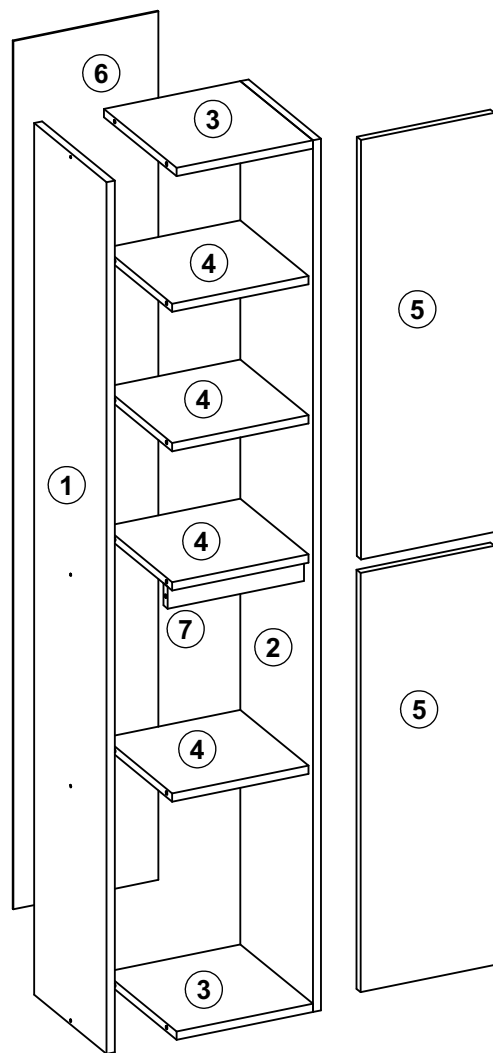



INSTRUÇÕES DE MONTAGEM
INSTRUCCIONES DE MONTAJE
ASSEMBLY INSTRUCTIONS

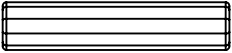
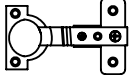

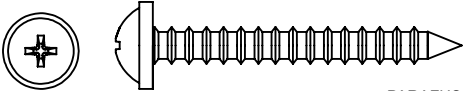
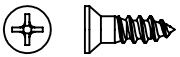
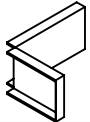
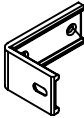
COD	DESCRIÇÃO/ DESCRIPCIÓN/ DESCRIPTION	QTD
1	LATERAL ESQUERDA/ LATERAL IZQUIERDA/ LEFT SIDE	1
2	LATERAL DIREITA/ LATERAL DERECHO / RIGHT SIDE	1
3	TAMPO/ TAPA/ TOP	2
4	PRATELEIRA/ ESTANTE/ SHELF	4
5	PORTA/ PUERTA/ DOOR	2
6	COSTA/ FONDO/ BACK	1
7	TRAVESSA/ TRAVESSAÑO/ CROSSPIECE	1

IMPORTANTE LER COM ATENÇÃO E GUARDAR PARA EVENTUAIS CONSULTAS.
 IMPORTANTE LEER CON ATENCIÓN Y GUARDAR PARA EVENTUALES CONSULTAS.
 IMPORTANT TO READ INSTRUCTIONS CAREFULL.

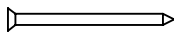
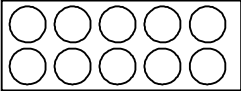
A		CAVILHA / CLAVIJA/ WOOD DOWEL Ø6X30MM	26
B		DOBRADIÇA/ BISAGRA/ HINGE (CANECO 26 CALÇO 12)	04
C		PARAFUSO/ TORNILLO/ SCREW Ø3,5x40 CC	08
D		PARAFUSO/ TORNILLO/ SCREW Ø5x60 CF	02
E		PARAFUSO/ TORNILLO/ SCREW Ø3,5x14 CC	20
F		PROTEÇÃO PARA SUPORTE/ PROTECCIÓN/ ANGLE BRACKET	02
G		SUPORTE FIXAÇÃO/ SOPORTE DE FIJACIÓN/ FIXING SUPPORT	02

H		BUCHA PLÁSTICA / CASQUILLO / BUSHING 8MM	02
I		COLA / PEGAMENTO / GLUE	01
J		PREGO/ CLAVO/ NAIL 10X10	28
K		ADESIVO TAPAFURO / ADHESIVO/ STICKER 12MM	08
L			01

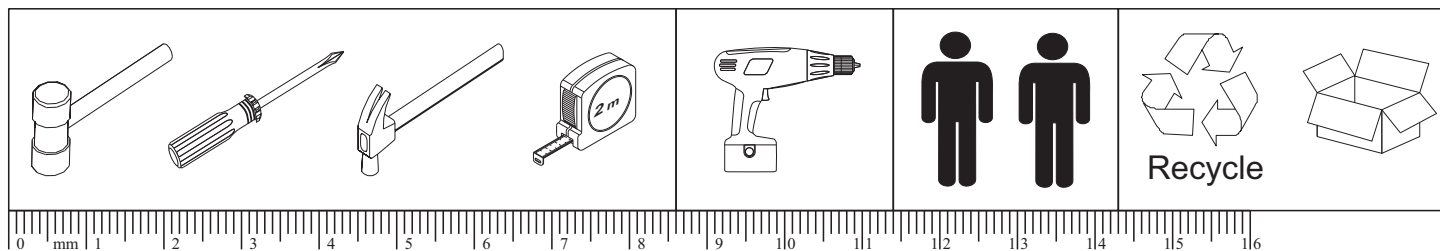

COLOCAR COLA "I" NAS CAVILHAS "A".
COLOCAR PEGAMENTO "I" EN LAS CLAVIJAS "A".
PLACE GLUE "I" ON DOWELS "A".

01

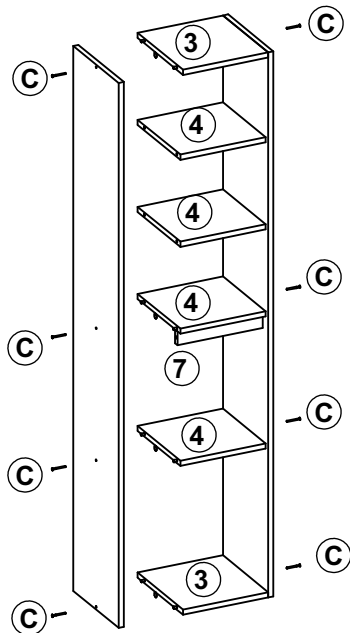
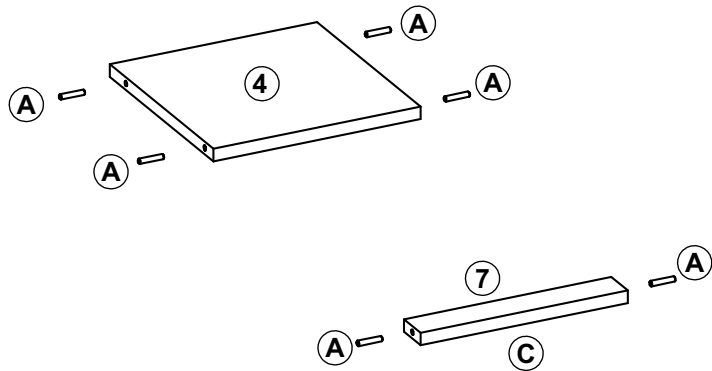

02

03

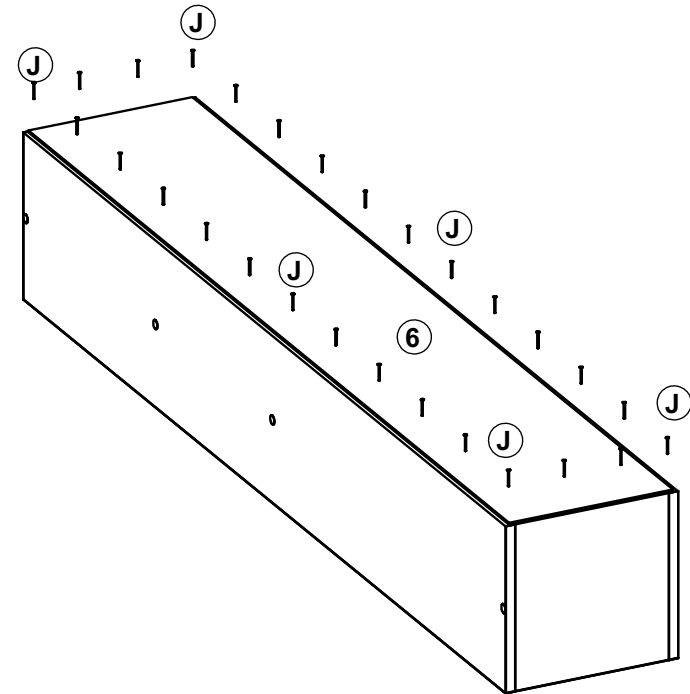

04

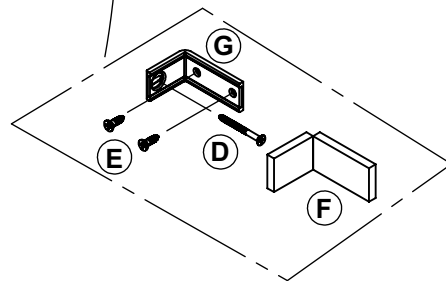
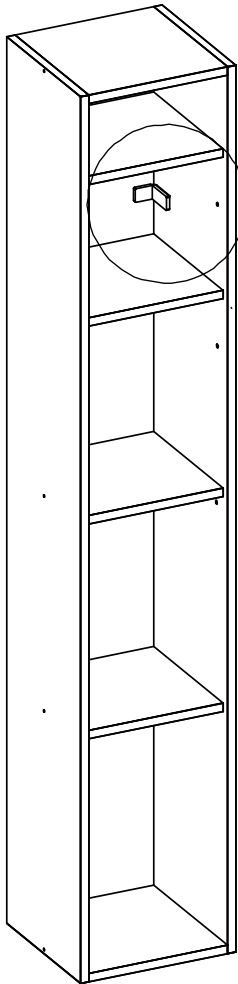

Broca não inclusa
Drill not included
Broca ø 8mm
Drill ø 8mm

1° 2x

2x 2°

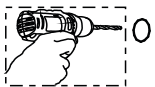

PAREDE
WALL
PARED

PAREDE
WALL
PARED

05

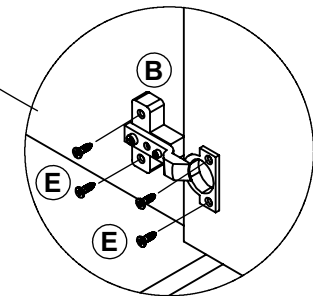
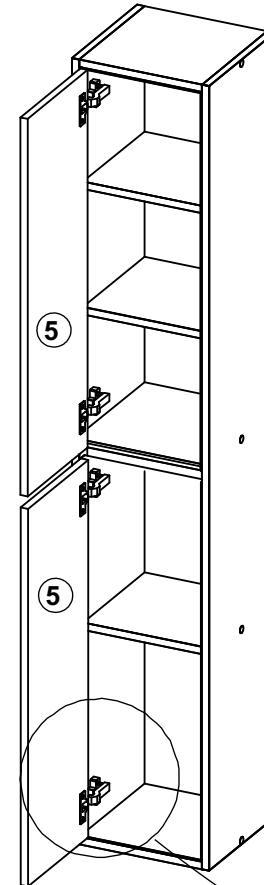

PESO MÁXIMO SUPORTADO PELO PRODUTO 25 KG.
PESO MÁXIMO SOPORTADO POR EL PRODUCTO 25 KG.
MAXIMUM WEIGHT TOLERATED BY THE PRODUCT 25 KG.