

HENNInd. e Com. de Móveis Henn
Mondai - SC - Brasil

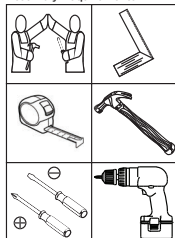

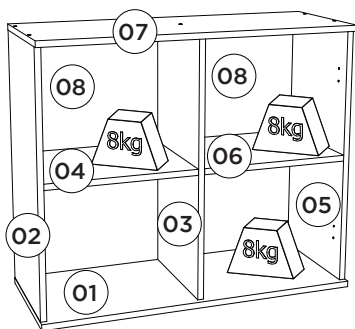

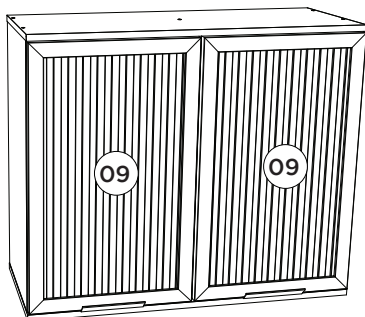



☎ +55 49 3674.3500

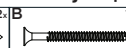

 @moveishenn
www.henn.com.br
INSTRUÇÕES DE MONTAGEM**INSTRUCCIONES DE MONTAJE
ASSEMBLY INSTRUCTIONS**
Aéreo O2 Portas Ripadas 800mm Connect | Aéreo O2 Puertas De Lamas 800mm Connect |
Aéreo O2 Slatted Doors 800mm Connect
Referência/Cor
C86-35 Duna/Cristal
C86-139 Off White
Requisitos para montagem
Requisitos para la montaje
Assembly Requirements

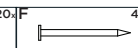
 Imagens meramente ilustrativas, não acompanha o produto.
 Imágenes ilustrativas, no incluidas con el producto.
 Illustrative images, not included with the product.

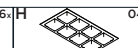
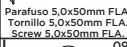
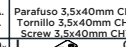
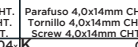
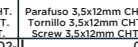
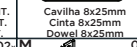
Pesos máximos recomendados com carga distribuída
Peso máximo recomendado con la carga distribuída
Recommended maximum weight with distributed load.
Lista de Peças | Lista de piezas | List of parts

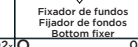
Item	Caixa Caja Box	Qtd Ctd Qty	Descrição Descripción Description	Medidas (mm) Dimensions (mm) Size (measurements) (mm)
01=07	1/1	01	Base tampo Base cubierta Base top	800x310x15
02=05	1/1	01	Lateral Direita Esquerda Lateral Derecha Izquierda Right Side Left	645x295x15
03	1/1	01	Divisão División Division	645x295x15
04=06	1/1	01	Prateleira Estante Shelf	376x295x15
05=02	1/1	01	Lateral Direita Esquerda Lateral Derecha Izquierda Right Side Left	645x295x15
06=04	1/1	01	Prateleira Estante Shelf	376x295x15
07=01	1/1	01	Base tampo Base cubierta Base top	800x310x15
08	1/1	02	Fundo Fondo Bottom	669x395x3
09	1/1	02	Porta Ripada Puerta de listones Slatted Door	639x394x20

Ferragens | Herrajes | Hardware

 02. A Parafuso 5,0x50mm FLA. Tornillo 5,0x50mm FLA. Screw 5,0x50mm FLA.	 10. B Parafuso 3,5x40mm CHT. Tornillo 3,5x40mm CHT. Screw 3,5x40mm CHT.	 28. C Parafuso 4,0x14mm CHT. Tornillo 4,0x14mm CHT. Screw 4,0x14mm CHT.	 04. D Parafuso 3,5x12mm CHT. Tornillo 3,5x12mm CHT. Screw 3,5x12mm CHT.	 20. E Cavilha 8x25mm Cinta 8x25mm Dowel 8x25mm	 20. F Prego 10x10mm Clavo 10x10mm Nail 10x10mm	 06. G Fixador de fundos Fijador de fondos Bottom fixer	 04. H Batente PVC para Porta Parada de PVC para Puerta PVC Door Stop
 09. I Adesivo tapa parafuso 10mm Adhesivo tapón de tornillo 10mm Bolt cover adhesive 10mm	 04. J Perfíl basidor 2015 150mm Profile Handle 2015 150mm	 02. K Bucha de plástico 8mm 8mm plastic bushing	 02. L Suporte de fixação Soporte de fijación Mounting bracket	 02. M Proteção para cantoneira Ángulo de protección Protection angle	 02. N Parafuso União 30mm Tornillo Unión 30mm Union Screw 30mm	 04. P Giz de correção Tiza de corrección Chalk of correction	

 Sachê de cola
Bolsa de pegamento
Glue bag

O parafuso (O) deve ser usada somente quando este módulo for acoplado a outro módulo componível Henn.



El tornillo (O) se debe utilizar sólo cuando el módulo está conectado a otro módulo componible Henn.



The screw (O) should be used only when this module is attached to another Henn modular module.

RECOMENDAÇÃO

Para fixar o móvel na parede usar o suporte de fixação (M), o parafuso 4,0x14mm CHT (C), a Bucha 8mm (L) e o parafuso 5,0x50mm FLA (A).

RECOMENDACIÓN

Para conectar el móvil a la pared con el soporte (M), tornillo 4,0x14mm CHT (C), el casquillo de 8 mm (L) y el 5,0 x50mm tornillo FLA (A).

RECOMMENDATION

To fix the furniture to the wall use the fixing bracket (M), the 4,0x14mm CHT (C) screw, the 8mm bushing (L) and the 5,0x50mm FLA screw (A).

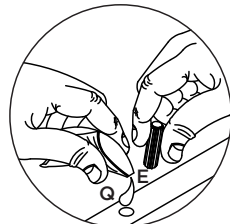
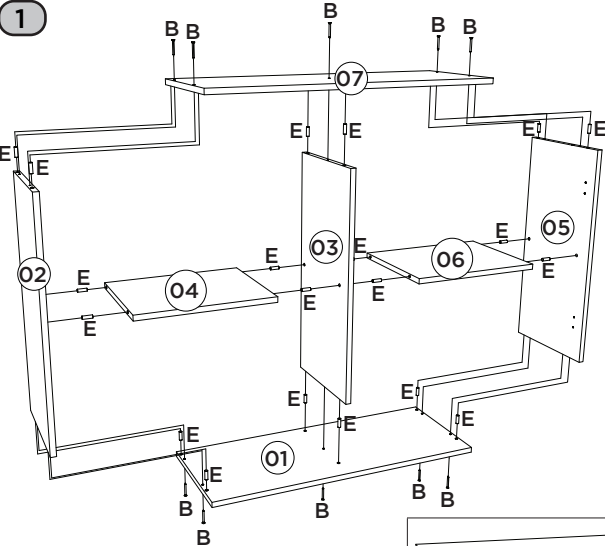

Utilizar o sachê de cola (Q) em todas as cavilhas (E) do produto.

Con el pegamento sobre (Q) en todos los pernos (E) producto.

Use the glue sachet (Q) on all the pegs (E) of the product.

AVISO
Para limpeza de seu móvel, use uma flanela seca ou umedecida, e não utilize produtos químicos que possam danificar seu produto.

SISTEMA DE MONTAGEM
O sistema de montagem dos produtos, funciona de acordo com a ordem crescente dos números indicados no desenho. Ex: 01, 02, 03, 04... até a conclusão da montagem.

ASSISTÊNCIA TÉCNICA
Para solicitação de Assistência Técnica você consumidor deverá entrar em contato com o Lojista a qual você realizou a compra deste produto e solicitar a assistência técnica das peças avariadas. A garantia abrange todas as peças, partes e componentes que eventualmente venham apresentar defeito de fabricação no prazo de 03 (três) meses, contando a partir da entrega do produto ao consumidor, mediante nota fiscal de compra. Se houver qualquer alteração na estrutura do produto ou ocorrer defeito por negligência do montador/consumidor em relação a instrução de montagem e manuseio, não será fornecido assistência técnica gratuita.

ADVERTENCIA
Para limpieza de su móvil, use una flanela seca o húmeda, y no utilice productos químicos que puedan dañar su producto.

SISTEMA DE MONTAJE
El sistema de montaje de los productos funciona de acuerdo con el orden creciente de los números indicados en el dibujo. Ej.: 01, 02, 03, 04... hasta la conclusión del montaje.

ASSISTÊNCIA TÉCNICA
Para solicitar Assistência Técnica, o consumidor deve comunicar-se com o Comércio que usou realizou a compra de este produto e solicita assistência técnica para as partes danificadas. La garantía cubre todos las partes, piezas y componentes que eventualmente puedan presentar defecto de fabricación en el plazo de 03 (tres) meses, contados a partir de la entrega del producto al consumidor, mediante factura de compra. Si se produce algún cambio en la estructura del producto o se produce un defecto por negligencia del montador/consumidor en relación con las instrucciones de montaje y manipulación, no se prestará asistencia técnica gratuita.

NOTICE
To clean your furniture, use a dry or wet cloth, and do not use chemicals that may damage your product.

ASSEMBLY SYSTEM
The products' assembly system works according to the increasing order of the indicated numbers. For example: 01, 02, 03, 04 ... to the end of the assembly.

TECHNICAL ASSISTANCE
To request Technical Assistance, the consumer must contact the retailer from whom you purchased this product and request technical assistance for the damaged parts. The warranty covers all parts, parts and components that may eventually present a manufacturing defect within a period of 03 (three) months, counting from the delivery of the product to the consumer, by means of a purchase invoice. If there is any change in the structure of the product or defect occurs due to negligence of the assembler/consumer in relation to the assembly and handling instruction, free technical assistance will not be provided.

