

MANUAL DE MONTAGEM

ATENÇÃO:

- 1 - Ler atentamente todo o manual antes de iniciar a montagem do móvel.
- 2 - A montagem deve ser feita em uma superfície plana e limpa.
- 3 - Recomenda-se utilizar a embalagem do móvel para forrar e chão e assim não danificá-los

LIMPEZA E CONSERVAÇÃO:

A limpeza do móvel deve ser feita com utilização de pano umedecido com água, podendo conter uma pequena quantidade de álcool. Não utilize produtos abrasivos.

GARANTIA:

90 dias para defeitos de fabricação.

Quantidade de pessoas
necessárias para montar o
móvel

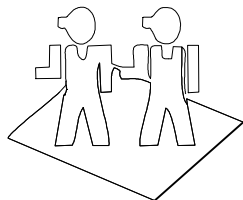

Tempo necessário para a
montagem: 1h





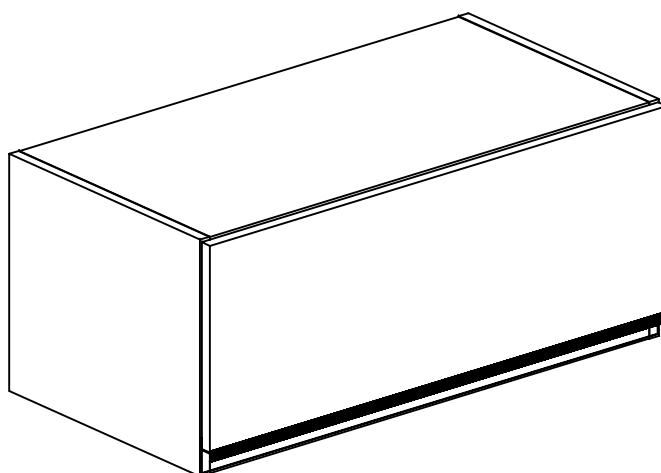
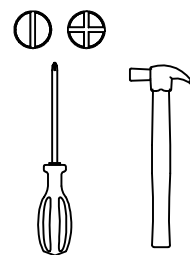





Ferramentas necessárias

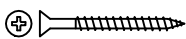
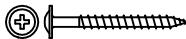

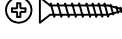

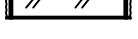

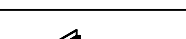





Lista de peças

Código de assistência	Descrição	Quant.	Compr. (mm)	Larg. (mm)	Espes. (mm)	Caixa/ volume
01	Lateral direita	1	300	352	15	A
02	Lateral esquerda	1	300	352	15	A
03	Base	1	570	352	15	A
04	Chapéu	1	570	352	15	A
05	Portas	1	596	262	15	A
06	Costas	1	590	290	3	A

Ferragem

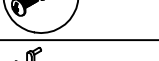
	Código de assistência	Descrição	Quant.
A	226	 Parafuso chato 4,0x40 bicromatizado	8
B	50311	 Parafuso flange 5,0x65	2
C	4214	 Parafuso chato 3,5x14 cabeça rebaixada	12
D	491	 Parafuso chato 4,0x25 bicromatizado	4
E	1802	 Cavilha 6x30mm	8
F	107	 Pregão 10 x 10	19
G	41	 Cola branca em bisnaga (10g)	1
H	25827	 Parafuso flange 3,5x14 zincado branco	2
I	58	 Etiqueta marca "Kappesberg"	1
J	44889	 Puxador aluminio maxxi 592mm bronze	1
K	7787	 Dobradiça reta 35	2

L	7787		Calço para dobradiça	2
M	7787		Parafuso panela 4,0x14 para dobradiça	4
N	40736		NO=Tapa furo adesivo 13mm Nogal	12
N	36059		AM=Tapa furo adesivo 13mm Amendoa	12
O	40534		Batente de silicone incolor	2
P	17024		Suporte aéreo metalizado zincado branco	2
Q	6959		Capa para suporte aéreo metal branca	2
R	529		Bucha ivasa	2
S	7373		Cantoneira plástica branca com capa	2
T	28505		Pistão a gás de 40N	1
U	8688		Parafuso união metálico	4
V	49286		Par de Ponteira bronze p/puxador maxxi	1
Acessório com parafusos e dobradiças (saco médio)				



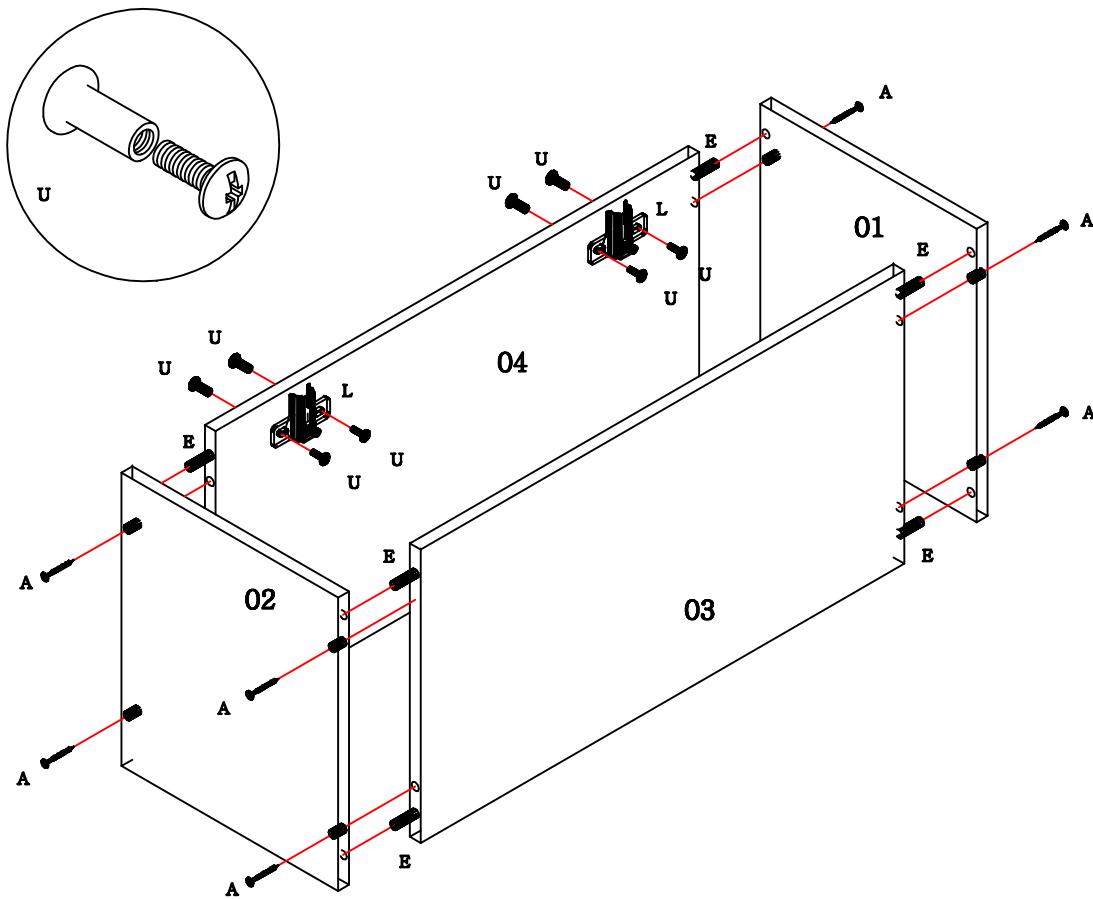

As batentes de silicone "O" são colocadas na porta, para suavizar eventuais impactos.

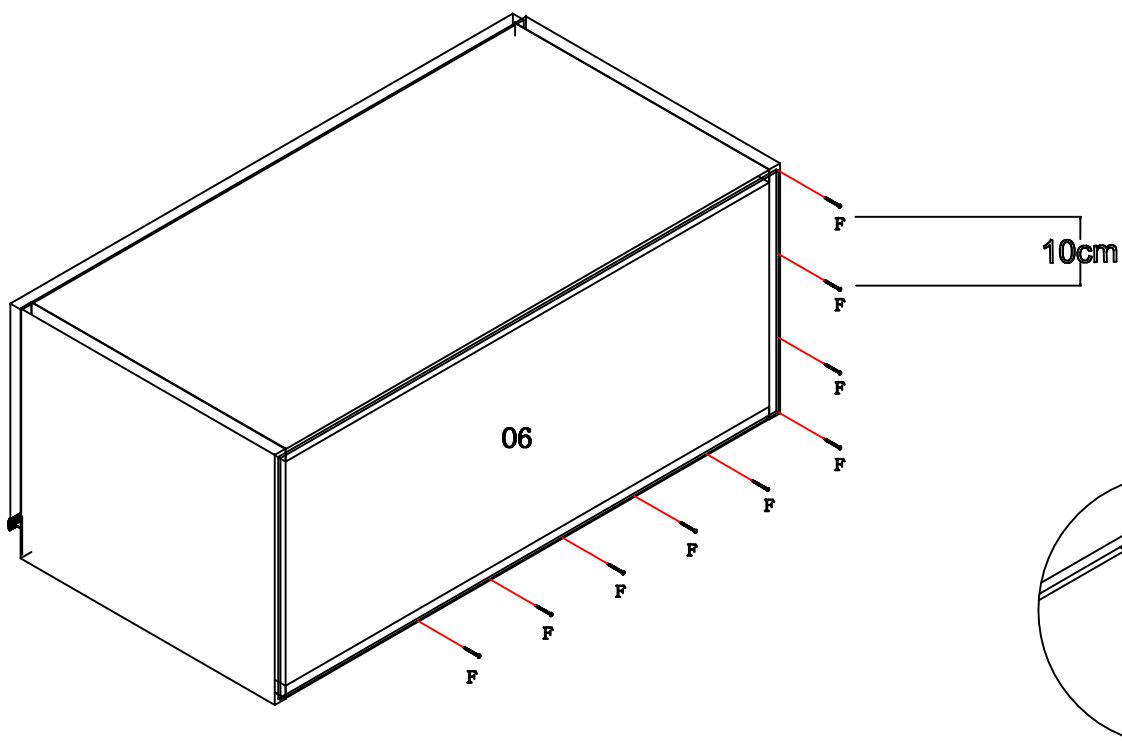

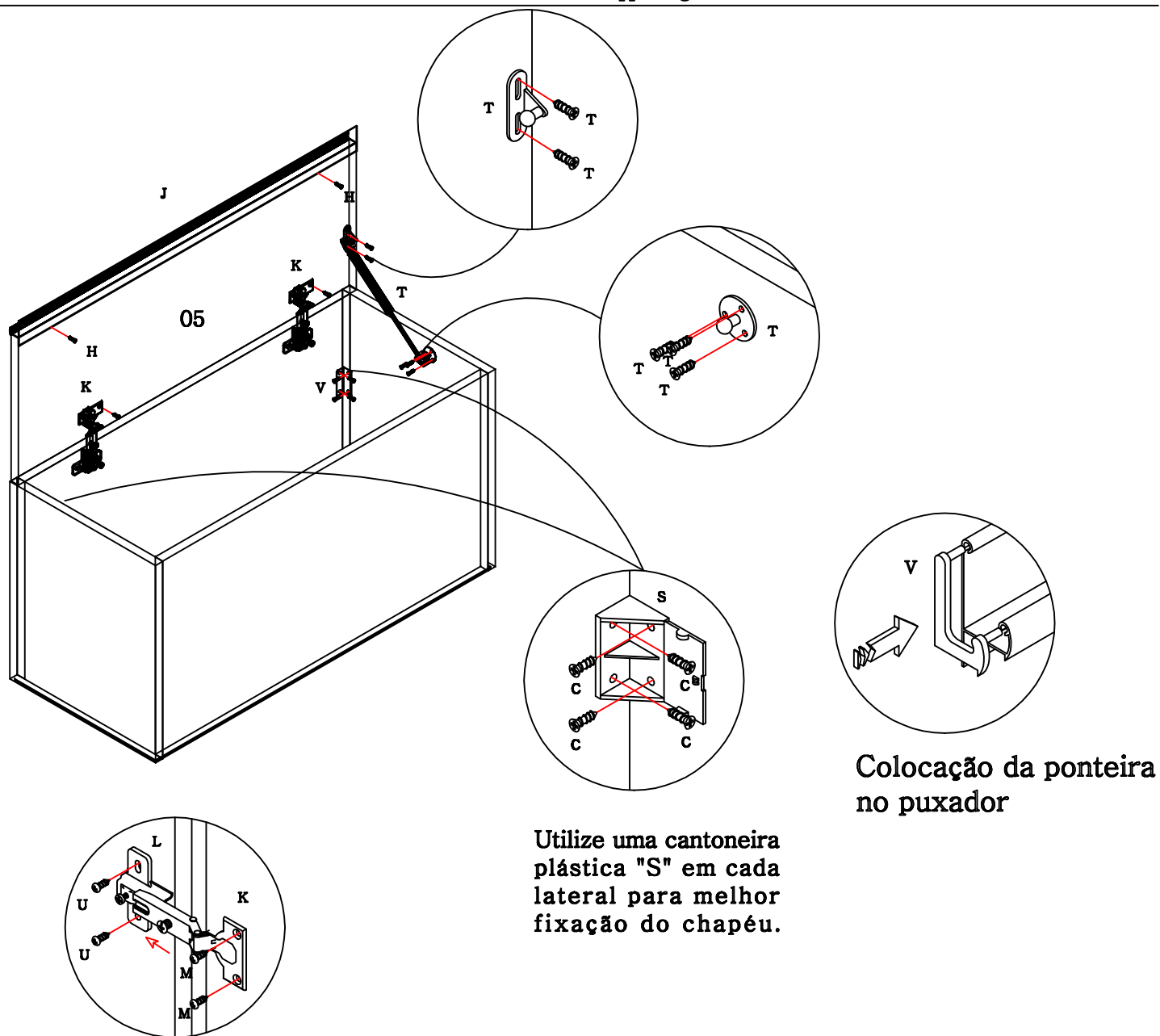

Colocação da ponteira no puxador

Utilize uma cantoneira plástica "S" em cada lateral para melhor fixação do chapéu.

A dobradiça "K" deve ser encaixada no calço "L" e estes colocados com os parafusos "M" na porta e "U" no chapéu, observando o procedimento a cima.

Utilize o parafuso "D" para fixar um módulo em outro.

Para montar a cozinha suspensa:

- Em cada lateral e um suporte aéreo metalizado "P" com o parafuso "C" e na parede com o parafuso "B" e com a bucha "R".
- Coloque uma capa "Q" em cada suporte "P".